



IMPULS

KÜCHEN

Sales manual

No. 137 ip valid from 01.01.2025

valid for orders received before 31.12.2025, last delivery not later than 28.02.2026

Art. No. 740449 EN

IMPULS
K Ü C H E N

Impuls Küchen GmbH
Hinterm Gallberg
59929 Brilon, Germany

T +49 2961 778 - 0
F +49 2961 778 - 6110
E info@impuls-kuechen.de
W www.impuls-kuechen.de

Colours pictured may differ slightly
from the originals due to printing
constraints.

Impuls kitchens may only be installed
by properly trained personnel. The
installation must be based on the
installation manual.

**You will find our current terms and
conditions of sale and delivery
on our website under Service /
Download.**

Sales manual

Change to range

NEW RELEASES

Front:

- IP 1200 Sage green no. 158
- IP 2200 Sage green no. 159
- IP 2200 Space grey no. 161
- IP 2200 Summerfield oak effect no. 162
- IP 2200 Summerfield oak effect (horizontal) no. 163
- IP 3150 White no. 167
- IP 3150 Magnolia white no. 168
- IP 3150 Pebble grey no. 169
- IP 3150 Cappuccino no. 171
- IP 3150 Sage green no. 164
- IP 3150 Space grey no. 172
- IP 7500 High-gloss white no. 173
- IP 7810 CK substrate, country-style modern, no. 397

Carcase decors:

- Summerfield oak effect no. 160

Visible side decors:

- White no. 167
- Magnolia white no. 168
- Pebble grey no. 169
- Space grey no. 172

Worktop decors (only in PLS finish):

- Summerfield oak effect no. 160
- Titian no. 165
- Terra grey no. 166

Handles:

- Shell handle, black no. 783
- Metal D-handle, black no. 784
- Metal D-handle, black no. 785
- Metal D-handle, black no. 786

Panel decors matt:

- Summerfield oak effect no. 160
- Sage green no. 158
- Titian no. 165
- Terra grey no. 166

Panel decors lacquer:

- Sage green no. 164
- White no. 167
- Magnolia white no. 168
- Pebble grey no. 169
- Cappuccino no. 171
- Space grey no. 172

Plinth decors:

- Summerfield oak effect no. 160
- Sage green no. 158

Miscellaneous:

- Standard drawer design with Servosoft (allow for surcharge!)

DISCONTINUED

Front:

- IP 1200 Sea maple effect no. 935
- IP 1200 Cranberry no. 122
- IP 2200 Sea maple effect, horizontal no. 944
- IP 2200 Sea maple effect no. 139
- IP 3150 White no. 902
- IP 3150 Magnolia white no. 903
- IP 3150 Pebble grey no. 927
- IP 3150 Cappuccino no. 124
- IP 3150 Space grey no. 955
- IP 4050 High-gloss black no. 925
- IP 4150 White no. 949
- IP 4250 Black no. 125
- IP 7500 High-gloss white no. 789
- IP 7810 CK substrate, country-style modern, no. 393

Colour Concept decors:

- CK332 Cranberry

Carcase decors:

- Sea maple effect no. 870
- Havana oak effect no. 850

Visible side decors:

- White no. 902
- Magnolia white no. 903
- Pebble grey no. 927
- Space grey no. 955
- High-gloss black no. 925

Worktop decors

- Sea maple effect no. 677
- Wild maple effect, alpine no. 127
- Graphite no. 669
- Green stone texture no. 131
- Terrazzo lapis grey no. 129

Handles:

- Metal D-handle, black no. 764
- Metal D-handle, copper effect no. 768
- Metal D-handle, black no. 769
- Metal D-handle, brushed steel effect no. 773
- D-handle, brushed anthracite/black no. 774

Panel decors:

- Sea maple effect no. 870
- Wild maple effect, alpine no. 127
- Cranberry no. 122
- Green stone texture no. 131
- Terrazzo lapis grey no. 129
- Graphite no. 830 (40 mm only)
- Concrete effect, slate light grey no. 683 (40 mm only)
- Concrete effect natural no. 674 (40 mm only)
- Concrete effect slate dark grey no. 684 (40 mm only)
- Lava grey, stone texture no. 648 (40 mm only)
- Carrara black no. 685 (40 mm only)
- White no. 902
- Magnolia white no. 903
- Pebble grey no. 927
- Cappuccino no. 124
- Space grey no. 955
- High-gloss black no. 925

Plinth decors:

- Sea maple effect no. 870
- Havana oak effect no. 850
- Cranberry no. 122

Miscellaneous:

- Drawer version 505 full extension
- Modular panel system 40 mm

New types are not available for discontinued models.

Services



Demand-oriented **delivery speed** (incl. **6-working-day express delivery service** for kitchen commissions)



Our maxim is **same-day processing** of your transactions (orders, customer service processes)



Delivery of reclaims on average in **8 working days**.

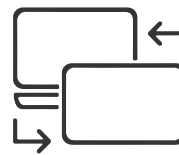

EDI (electronic data interchange) and other modern processing methods are a matter of course for us.



We are at your service **Mondays to Fridays** by phone **as follows**:
In German 8:00 am until 5:30 pm
International: 8:00 am until 5:00 pm



Graphic order confirmation with layout, front view, worktop drawings and cornice drawings / with 3D view on request.



At your request, we can provide **training** in the range for your staff



Our understanding of **quality** is the entire process from building the component parts to fitting the kitchen



Your local **sales team** will answer all order-related questions (they are always available, you will not be transferred, and your request will be dealt with in one phone call)



The **Customer Information System (CIS)** gives you 24/7 online access to your IMPULS data.



The **IMPULS online planner** makes it very easy for the consumer to plan a kitchen. As your planning partner, we give you the online planning tool for you to integrate on your web site.



The **Media Portal** provides a very easy and convenient platform for collecting your picture and information material. Completely free to use, the portal impresses with its ease of use.

Express delivery service



The express kitchen!

On target in next to no time: with our kitchens, the joy of living starts after only a short time. When it comes to speed and quality of service, our express delivery service within Germany is quite simply unbeatable. And the best thing is that all our kitchens can be planned freely and individually. So: what are you waiting for? Better get started right away!

General order information:

Please note that all order queries must be resolved.
Any information provided on our delivery notification are to be observed.
Once received, orders cannot be amended.
Selection of order variant QUICK or PRIME in the header data of the kitchen order.
The surcharge item must be included in the order.
Only individual kitchens are possible. Does not include professional or stock kitchens.
Advertising campaigns are to be agreed in advance with the service team.
Preferential acceptance of express delivery kitchens (maximum waiting time 1 hour).
CK ranges and glass recess back panels are not included in the express delivery service.

PRIME

Delivery in 6 Impuls working days

Please send us your order as follows, to arrive by 11.00 a.m.:

By email to: prime@impuls-kuechen.de

By fax to: +49 2961 778-8884

Please select delivery type PRIME in the order header.

Surcharge item **ZUSPRIME** must be included in the order as an article in the itemised list.

It is invoiced via the product category „Net items“.

This delivery service is only available within Germany (excluding German islands).

QUICK

Delivery on average in 14 Impuls working days

Please send us your order as follows, to arrive on Tuesday by 7.00 a.m.:

By email to: quick@impuls-kuechen.de

By fax to: +49 2961 778-8883

Please select delivery type QUICK in the order header.

Surcharge item **ZUSQUICK** or **ZUSQUICKF** must be included in the order as an article in the itemised list.

It is invoiced via the product category „Net items“.

Delivery time from order receipt:

Tuesday by 7.00 a.m.: between 9 and 13 Impuls working days

Tuesday after 7.00 a.m.: between 14 and 18 Impuls working days

This delivery service is available for the following countries: Germany, France, Austria, Switzerland, Benelux countries (excluding islands)

Express delivery service



We'll be happy to do that for you!

Our „Consumer Delivery“ service gives you the following benefits:

- No putting goods in storage
- No outsourcing
- No shipping of goods to consumer
- No carrying of goods at consumer

Information we need from you for this service:

- Consumer's address
- Consumer's telephone number(s)
- Consumer's email address

Procedure

- Generation of special documents needed for delivery to consumer. It is possible to include our customer's logo and address details in the paperwork
- 2-man handling
- Carrying to the place of use
- Once the goods have arrived at the distribution centre and have been checked to make sure everything is complete and there is no visible damage, our service provider's staff will contact the consumer to arrange a delivery date.
- Track & Trace is provided for customers to keep them up to date on delivery status at all times

Note:

- Surcharge **ZUSENDKDB** item must also be ordered **per purchase contract**.
- Consumer Delivery cannot be combined with the „Quick“ and „Prime“ express delivery services.
- Delivery within Germany (excluding German islands).

Quality and environment



GS seal of approval

The globally recognised GS symbol assures that our products satisfy the quality and safety standards of the German product safety law (short form: ProdSG). The GS seal is a valuable aid to decision making when buying and strengthens the trust of your customers: They can rely on the quality and safety of our products.



RAL quality mark „Golden M“

The „Golden M“ represents proven quality, guaranteed safety and healthy living.

The German Deutsche Gütegemeinschaft Möbel e.V. (DGM) campaigns for safety and health. With the „Golden M“, the DGM is making a statement that you will only receive furniture that has been thoroughly tested. The furniture must be sturdy, safe, durable and well manufactured - and may not contain any materials that are hazardous to health.

You will find further information on the „Golden M“ and on the emissions label at www.dgm-moebel.de



Furniture Made in Germany

Since 01 August 2020, a new label has provided information on the quality of furniture: the label guaranteeing geographical origin under RAL-RG 0191 „Furniture Made in Germany“ identifies cabinets, chairs etc. from Germany that verifiably meet strictly defined criteria.

The label is linked with strict conditions that were laid down by the German Institute of Quality Assurance and Certification (RAL). The label was developed and introduced by RAL in cooperation with VDM (The Association of the German Furniture Industry). Adherence to the requirements is monitored by the German Furniture Quality Assurance Association (DGM) on behalf of VDM.

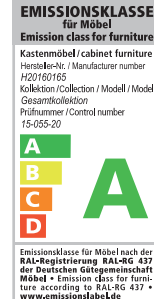

DGM emission label

The emission label provides information on pollutant emissions and is intended to protect against harmful effects on health.

Classification ranges from class A to class D, with A standing for the highest rating.

The label, which was developed by the Deutsche Gütegemeinschaft Möbel e. V., refers to a collection or an item of furniture.

Evidence of classification is provided on the basis of the appropriate emissions tests. The label is issued exclusively by the Deutsche Gütegemeinschaft Möbel e.V.



PEFC certification

We are PEFC-certified. PEFC stands for the „Programme for the Endorsement of Forest Certification Schemes“, and is the world’s biggest independent organisation for the assurance and constant improvement of sustainable forest ensuring ecological, social and economical standards.

All the wood that we use for our kitchen furniture is proven to come from ecological, economical and sustainable forestry.



Recycling certificate

We have received recycling certification from RKT Recycling Kontor Transportverpackungen GmbH & Co. KG (transport packaging recycling company) for participating in the take-back and recycling system.

This ensures that the packaging is collected and recycled by RKT disposal partners. Our contract no.: TV000109

Product information

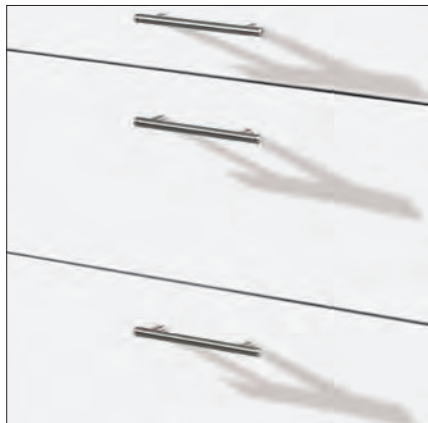

Doors

The laminated surfaces are resistant to most normal household soiling. Surfaces of wooden doors have on the inside and on the outside a lacquer protection. Colour variations due to different lightings are beyond our control.

Please note that for edge joins, the finishes are offset and not continuous.

Lacquered and foil wrapped fronts are delivered with a protective wrap that must be removed immediately upon receipt of the furniture.

Specified front thicknesses are approximate and may differ slightly.

Deactivate your dishwasher's automatic door opening system. Over time, steam will damage the material. Impuls Küchen does not accept any liability for the surrounding components.



Anti-fingerprint

Fronts with this symbol come with a high-quality anti-fingerprint finish.



Carcase

Unit sides and visible base shelves are made of three-layer chipboard, 16 mm thick, with melamine resin coating on both sides. The interior colour is white. The front side of the carcass is fitted with coloured 1 mm thick edging, the rear side with a neutral melamine edging (exception: the edges of the plinth bases and the base unit cross member edges are white). The corner connection of the base, tall and wall units is dowelled. The colour appearance can change slightly in different light sources (metamerism).

Rear panels (without ill.)

These are made of one piece of hardboard, lacquered on one side, grooved on the edges and stapled to the shelves. For improved air circulation, they are set forward in relation to the carcass rear edge by 35 mm in base units, tall units, highboards and depth reduced units, and by 16 mm in 326 mm deep units.

Deactivate your dishwasher's automatic door opening system. Over time, steam will damage the material. Impuls Küchen does not accept any liability for the surrounding components.

Product information



Worktops

The worktops are approx. 25/40 mm thick and made from high-quality triple-layer chipboard. The surface is covered with brand laminates. Worktop corner connections are made with tongue and groove plus a draw bolt. An elastic PU adhesive ensures a sealed connection. Prior to gluing the worktops, they are to be checked for fitting compatibility and damage. Any reclaims will not otherwise be accepted. Cut-outs must be sealed on site. All decors have different areas of finish and colour in the structure of the pattern. Wood and stone design are a natural wood or stone reproduction that is printed in an extensive process with high-quality colours. The design is based on original woods or stones, so the reproduction even includes the changes in lightness, colour and structure that are seen in natural wood and stone. These natural nuances in the lightness and colour may under certain circumstances be clearly visible in the join area between two worktops. These differences are unavoidable on natural stone reproductions, and not a manufacturing fault. With worktop joins, a continuous and identically coloured course of the texture is not possible for manufacturing reasons. Colours and structures may vary when additions to existing worktops are required.

No surcharge is calculated **for the tongue and groove joint** of the 40 mm worktops ordered.

Deactivate your dishwasher's automatic door opening system. Over time, steam will damage the material. Impuls Küchen does not accept any liability for the surrounding components.



Wall connection (not ill.)

The sealer strips have flexible rubber-like strips on both sides to ensure a tight seal between wall and worktop. The sealer strips are made of synthetic material with a snap-on cover strip, and blend harmoniously with the kitchen as a whole.

Table attachments

The planning engineer is responsible for larger table attachments exceeding 900 mm in width x 1600 mm in length and the fitter is responsible for their installation!



Drawers and pull-outs

They guarantee the optimum, neat and tidy use of the storage space, as well as a high level of convenience and functionality. This is characterised by the following quality features:

- double-walled, powder-coated steel runners with concealed integrated runner guide, high load-bearing capacity up to 30 kg (including drawer/pull-out)
- quiet operation
- drawer stop to prevent falling out
- automatic interlock
- In standard full-extension pull-out **with Servosoft (allow for surcharge!)**
- Self-closing over the last few centimetres
- sturdy 16 mm thick, melamine coated drawer base
- very easy to clean thanks to softly rounded inner corner between runner and bottom of drawer
- spring mechanism between drawer front and frame to absorb impacts
- precise horizontal and vertical adjustment of drawer front
- additional adjustment of angle of tilt with pull-out front pieces
- additional rail on pull-outs
- snap technology makes changing drawer fronts easy
- heavy-duty pull-out up to 50 kg with 800, 900, 1000 and 1200 mm wide pull-outs (including pull-out)
- no heavy-duty pull-out with depth reductions on 800, 900, 1000 and 1200 mm wide pull-outs
- system load capacity including net weight: (carcase depth 560 mm)
 - 30 kg - drawer / interior drawer
 - 30 kg - pull-out
 - 50 kg - pull-out > 600 mm

Product information



Plinth

- All base units are fitted with plinth feet made of recyclable, shock and moisture-resistant laminate with screws for adjusting the height.
- Base runners with pegs provide a firm attachment to the bottom of the cabinet. The plinth is inserted into the adaptor when the kitchen is fitted.
- In addition to the standard plinth height of 105 mm, other plinth heights (155 mm and 205 mm) are available at no extra charge.
- The height can be adjusted from +25 mm to -10 mm by means of the adjusting screw.
- Load capacity 50 kg/plinth foot (including weight of unit)
- The base runner is set back by 70 mm from the front edge of the carcass.
- The optimum trim panel attachment is achieved by means of the grid element and side clips.
- The plinth panel can be removed at any time and is protected at the bottom by a rubber-like sealing profile.



Accessories

There is an extensive choice of practical and useful accessories. They can be integrated when planning a kitchen or can be ordered at a later stage.

Product information



Drawers / pull-outs in standard finish

TANDEMBOX plus

- Colour silver grey
- Full-extension pull-out with Servosoft
- Tubular rail on pull-outs
- Open side panel on pull-outs
- Optional side panels for pull-outs in silver grey for clipping onto the railing (see Accessories 10.xx)

Version:

506 = full-extension pull-out with Servosoft (allow for surcharge!)

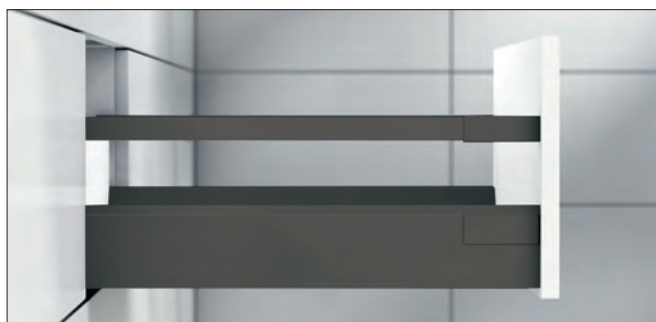

Drawers / deep drawers

Professional version (surcharge)

TANDEMBOX antaro

- colour anthracite
- full-extension deep drawer with Servosoft
- rectangular rail for deep drawers
- open side wall for deep drawers
- optional side panels for deep drawers in clear glass and frosted glass (see Accessories 10.xx)

Versions:

508 = per full-extension deep drawer with Servosoft (surcharge)



Drawers / deep drawers

Professional version with glass side panel (surcharge)

TANDEMBOX antaro

- colour anthracite
- full-extension deep drawer with Servosoft
- rectangular rail for deep drawers
- clear or frosted glass side panels for deep drawers

Versions::

510 = Professional with Servosoft and clear glass

512 = Professional with Servosoft and frosted glass

Product information

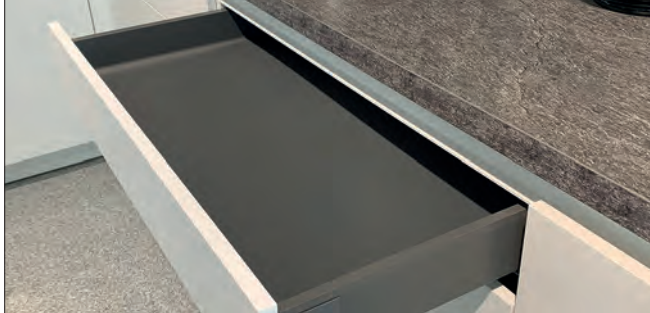

Non-slip mats (surcharge)

- Colour silver-grey or anthracite
- All drawers / deep drawers / revolving and swivel shelves in a batch are fitted with the available non-slip mats

Variant drawer / deep drawer features:

- 99 = Without non-slip mat
- 106 = Non-slip mats in silver-grey
- 108 = Non-slip mats in anthracite

Can be ordered individual as separate items.



Interior

Our interiors are available in the colours **silver grey and anthracite**. Both colours are optimised to the drawer / pull-out type.



Inner drawers

Storage space on two levels. If choosing a drawer unit with inner drawers, please remember the drawer drivers.

Product information



Clip hinge (standard) Version 414

All-metal self-closing clip hinges by Blum combine modern technology, function and design.

In combination with high-quality flap stay



Cushioning for hinged doors Top Motion (surcharge) Version 418

CLIP top BLUMOTION concentrates innovative technology, international award winning design and motion convenience in the smallest of spaces. Because the BLUMOTION cushioning mechanism is integrated in the hinge cup. Thanks to the integrated BLUMOTION, doors always close gently and quietly.

The BLUMOTION cushioning adjusts the dynamics of the door during closing. The load due to the weight of the front is also taken into consideration, as is the momentum used to push closed.

In combination with high-quality flap stay



Cushioning for hinged doors Top Motion Plus (surcharge) Version 428

CLIP top BLUMOTION concentrates innovative technology, international award winning design and motion convenience in the smallest of spaces. Because the BLUMOTION cushioning mechanism is integrated in the hinge cup. Thanks to the integrated BLUMOTION, doors always close gently and quietly.

The BLUMOTION cushioning adjusts the dynamics of the door during closing. The load due to the weight of the front is also taken into consideration, as is the momentum used to push closed.

In combination with AVENTOS HKS flap stay by Blum

Product information



141 + 3 mm grid size for cabinet heights combined with a base unit height of 723 mm

- Ideal lines
- Flexibility for planning
- Proven base unit height of 723 mm (5 grid levels)
- Base unit height 867 mm (6 times the grid size)



Uniform front divisions of 3 mm throughout

- Elegant thin join just 3 mm wide (horizontally) (6 mm vertically)



Recess height 565/580mm

- ergonomically functional: the ideal space for working and for kitchen appliances
- looks perfect



Variety of cabinet heights

- 7 base unit heights (147, 291, 363, 435, 579, 723 and 867 mm)
- 6 tall unit heights (1043, 1475, 1619, 1907, 2051 and 2195 mm)
- 6 wall unit heights (291, 363, 435, 579, 723 and 867 mm)
- 3 top-mounted cabinet heights for worktops (1144, 1288 and 1432 mm)



Cabinet widths - Planning variety

- 11 base unit widths with hinged doors, drawers and deep drawers
- 9 wall unit widths
- 5 tall unit widths
- Width reduction down to the next smallest unit width to 300 mm wide

Product information



Variety of cabinet depths

- Base unit depth 326, 460, 560 mm (326 and 460 mm for selected types)
 - Top and side unit depth 560 mm
 - Top-mounted, wall and display unit depth 326 mm
 - Variable depth reduction between 560 and 310 mm in base units and tall units
 - Variable depth reduction between 326 and 250 mm in wall units
- The corresponding items are indicated with the depth reduction pictogram.

From a cabinet height of 723 mm, base units, highboards and tall units can be given extra-deep carcass sides to a maximum of 660 mm.



Width and depth reduction

It is possible to reduce the width and depth of various cabinet types. These cabinets are identified by the corresponding pictogram. Please observe the legend provided for the articles. Of course, it is also possible to combine reductions in width and depth.



Worktop depths - Planning variety

- 5 worktop depths (600, 700, 800, 900 and 1200/1197 mm)
- Worktop depth can be reduced to a depth of 250 mm



Wall unit fixings

Particularly easy and safe installation by wall strip and special fitting in the wall unit. Three-directional adjustment possible without removing the unit. The condition of the walls must be checked before mounting the wall units (and shelves). Suitable mounting hardware must be provided by the customer if necessary. Wall units which are fitted alone must be secured with additional angle brackets to prevent them being lifted out.



Hinges

The self closing clip metal hinges combine modern technology, efficiency and design. They are continually subject to hard durability tests as all fixings are. The opening angle of 107° gives unhindered access to the cupboard. The hinges can be adjusted in three directions.

Versions:

- 414 clip-on hinge = hinge without cushioning
- 418 Top Motion (surcharge) = hinge with integrated cushioning for hinged doors and an exclusive flap stay for flap doors
- 428 Top Motion Plus (surcharge) = hinge with integrated cushioning for hinged doors in combination and AVENTOS HKS flap stay by Blum for flap doors

Product information



Wooden shelves

They are 16 mm thick with melamine coating on both sides and neutral thick-edge at the front (white 1.0 mm), neutral laminate edge at the rear and sides. The shelves rest on height adjustable pegs.

Adjustable shelves, glass shelves and structural shelves can be uniformly loaded with up to 50 kg/m² area.

Glass shelves / supports

They are 8 mm thick. Wall units with glass shelves include an exclusive glass shelf support with rubber coating.



Standard flap stay in conjunction with buffering for hinged doors

Closes the flap door in a perfect movement, gently and quietly. Depending on the setting, the flap stay will safely hold the front in any position. The buffering gently slows the front down when closing it.

The flap stay is not cushioned in the standard version (version 414).

Version:

418 Top Motion = in combination with CLIP top BLUMOTION buffer for hinged doors by Blum



AVENTOS HKS flap fitting from Blum

Available as a premium version at an extra charge.

The flap fitting from Blum holds every position!

If the energy-storage mechanism is set precisely to the front weight, the flap remains in every desired position thanks to the seamless stop mechanism – and is thus always easily reachable for closing.

Version:

428 Top Motion Plus door cushioning = in combination with CLIP top BLUMOTION buffer for hinged doors by Blum



Uniform colour scheme

The tops and undersides of the wall units are colour coordinated to match the carcass colour, giving all visible surfaces in the kitchen a uniform appearance.



Modular panel system for modern designs

- 2 panel thicknesses (16 and 25 mm)
- in carcass height or to floor level with support panel shoe
- Variable panel dimensions

Product information



Installation instructions

You will find information on assembling the kitchen in our installation instructions. You can download them as a PDF file from our website under Downloads.



Care information / care instructions

To ensure that your kitchen gives you lasting pleasure, we have put together some information on caring for the materials and how to retain their value. You will find this information on our website under Downloads. Please give the care instructions to your customers.

Instructions for ordering

The following information is required in order to process orders quickly and completely:

- Exact company and delivery address
- Customer reference
- Date of order
- Delivery date
- Dispatch type (truck / collection)
- Range with no.
- Front colour with no.
- Handle finish / handle position with no.
- Carcase colour with no.
- Plinth colour with number
- Cornice
- Working height:
 - standard height 868 mm with 105 mm plinth
 - On request 918 mm high with plinth 155 mm or 968 mm high with plinth 205 mm
- Worktop finish (PLR/PLS, based on decor)
- Worktop colour and edge no.
- For worktops: please indicate the positions of joints and cut-outs if desired
- Order plinth trims and sealer strips in fixed lengths
- Hinge type
- Drawer finish
- Niche colour / motif
- Panel colour with no.
- Support panel shoe colour with no.
- Shelf colour with no.
- Ventilation grille colour with no.
- State the type of appliance for appliance housings.
- State the dimensions for decor finishes for electrical appliances.
- For glass doors (if there is a choice), state whether fronts are the same or in an alternative shade.
In the event of deviations, state no. of glass door colour.
- State glass door frame finish and type of glass (if there is a choice).
- Drawer/pull-out features
- Top and bottom panel features
- Detailed list of items
- Sketch with dimensions, possibly sketches of worktops and cornices.
- For orders that contain a hob we are obliged, for product liability reasons, to confirm and deliver a hob base unit with the appropriate heat resistant panel.
Cancellation/modification is not possible.
For appliances from a third-party (hob not provided by us), we urgently require written confirmation that a unit with a heat resistant panel is not desired or required.
- For safety reasons, hobs must not be installed above built-under appliances.
- We always advise against planning normal wall or glass wall units above hob base units with hobs.
Please include extractor hood units for this planning situation.

The figures in the respective price group columns represent addable identification numbers and not prices.

Retailers will use their own specific multiplication factor for pricing, arriving at the price on the basis of the ID codes. Prices charged are those valid on the day of the delivery plus VAT. All rights reserved for technical modifications in the ranges, material, finish and dimensions, particularly in the interest of technical progress, in addition to printing errors in the ID codes.

The data in this price list is compiled for computer-aided kitchen planning in IDM format by G02B GmbH and made available to all software houses for further processing and conversion to their planning systems.

Information on processing orders for combinations of fronts

With our company, it is possible to combine different fronts within a range in a kitchen order. This means, for instance, that you can combine the colours of a range in a kitchen just as you wish. When ordering please make sure that items are clearly and correctly designated with the colour numbers stated in the Sales Manual. To avoid mistakes when combining different colours, we ask you to check these in particular in the order confirmations. The colour finish for the particular product is shown in the item line. Deviating colour numbers are clearly highlighted there.

And now we would like to take this opportunity to wish you every pleasure in planning „lively“ kitchens, and hope your customers enjoy their kitchens from our company just as much.

Colour Concept

Information and ordering advice



Kitchen in colour? That is no problem with our Colour Concept!

Whether you would like to have your entire kitchen lacquered in your chosen colour, for example, or individual units or areas: For all options, the extensive Colour Concept lacquering does not just offer a multitude of possibilities for creative design, but also lends much greater value retention.

Front panel colours

Our best-seller colours are available for selection.
These 11 colours are available for 3 „fronts“ or ranges.

Colour Concept colour samples

For technical printing reasons, the colours shown only serve as guides. They are not binding. Colour matching for deliveries is only possible within one batch. When reordering, minor deviations cannot be ruled out.

Fronts / ranges

3 Ranges for matt lacquer are available.

Accessories

The 3 ranges of our Colour Concept also include accessories such as cornices, light pelmets, plinths, shelf units, modular panels and pilasters.

The ordering process

- Please send your order via e-mail to ck@impuls-kuechen.de or via fax to the following fax number: (0049) 2961 / 7 78 – 63 33
- Upon receipt of your order you will receive an order confirmation from us as usual.
- Varying delivery times apply in accordance with the latest delivery time information.
- The express delivery services are not available for Colour Concept.

Carcase dimensions

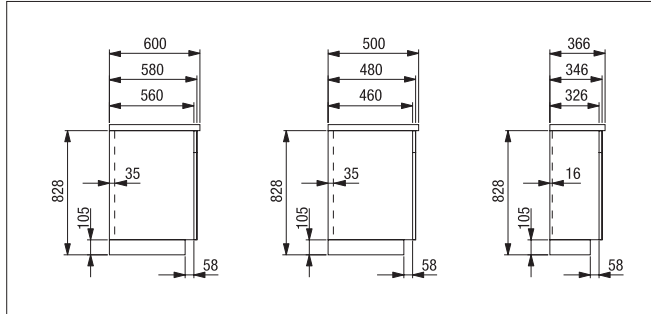

Base units

Widths: 150, 250, 300, 400, 450, 500, 600, 800, 900, 1000, 1200 mm
 Heights: 291, 363, 435, 579, 723, 867 mm (without plinth or worktop)
 Depths: 326, 460, 560 mm without front, approx. 346, 480, 580 mm with front

The rear panels in 560 mm deep units are inset 35 mm from the back edges. This ensures adequate air circulation. Moreover, service installations can also be surface-mounted at a later date and concealed behind the units without difficulty. The back panel of 326 mm deep units is inset 16 mm from the back edges. Wooden shelf depth in carcase 560 mm deep: 465 mm
 Wooden shelf depth in carcase 326 mm deep: 250 mm

From a cabinet height of 723 mm, base units can be given extra-deep carcase sides to a maximum of 660 mm.

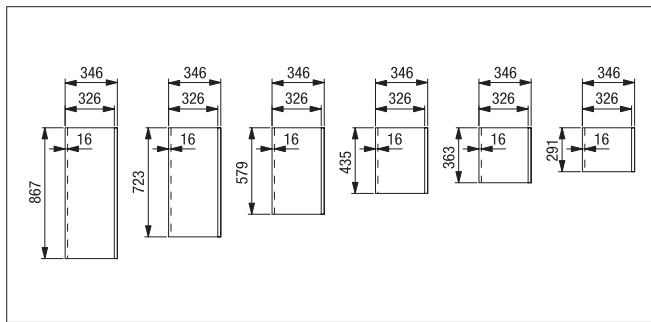

Wall units

Widths: 250, 300, 400, 450, 500, 600, 800, 900, 1000 mm
 Heights: 291, 363, 435, 579, 723, 867 mm.
 Depths: 326 mm without door, approx. 346 mm incl. door.

The back panels of wall units are inset 16 mm from the back edge. This void allows for cable runs for under cabinet lighting, and allows for easy tiling. Wooden shelf depth in carcase 326 mm deep: 250 mm

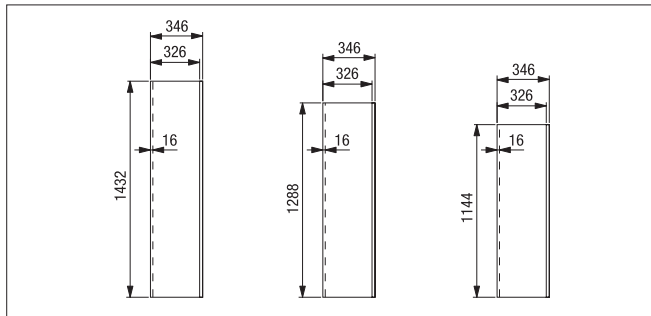

Top-mounted units for worktops

Widths: 600, 650 mm
 Heights: 712, 1043, 1144, 1288, 1432 mm
 Depths: 326, 560 mm without front, approx. 346, 580 mm with front

The back panels of top-mounted units are offset inwards by 16 mm on 326 mm deep units. On 560 mm deep units, the back panels are offset inwards by 35 mm. This void allows for cable runs for under cabinet lighting, and allows for easy tiling.

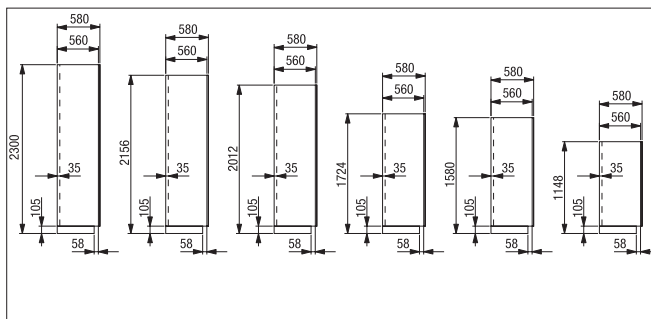

Tall units

Widths: 250, 300, 450, 500, 600 mm.
 Depths: 1043, 1475, 1619, 1907, 2051, 2195 mm (without plinth)
 Depths: 560 mm without door, approx. 580 mm incl. door.

The back panels of units are inset 35 mm from the back edge. This ensures adequate air circulation. Moreover, service installations can also be surface-mounted at a later date and concealed behind the units without difficulty.

From a cabinet height of 723 mm, tall units and highboards can be given extra-deep carcase sides to a maximum of 660 mm.

System of measurements

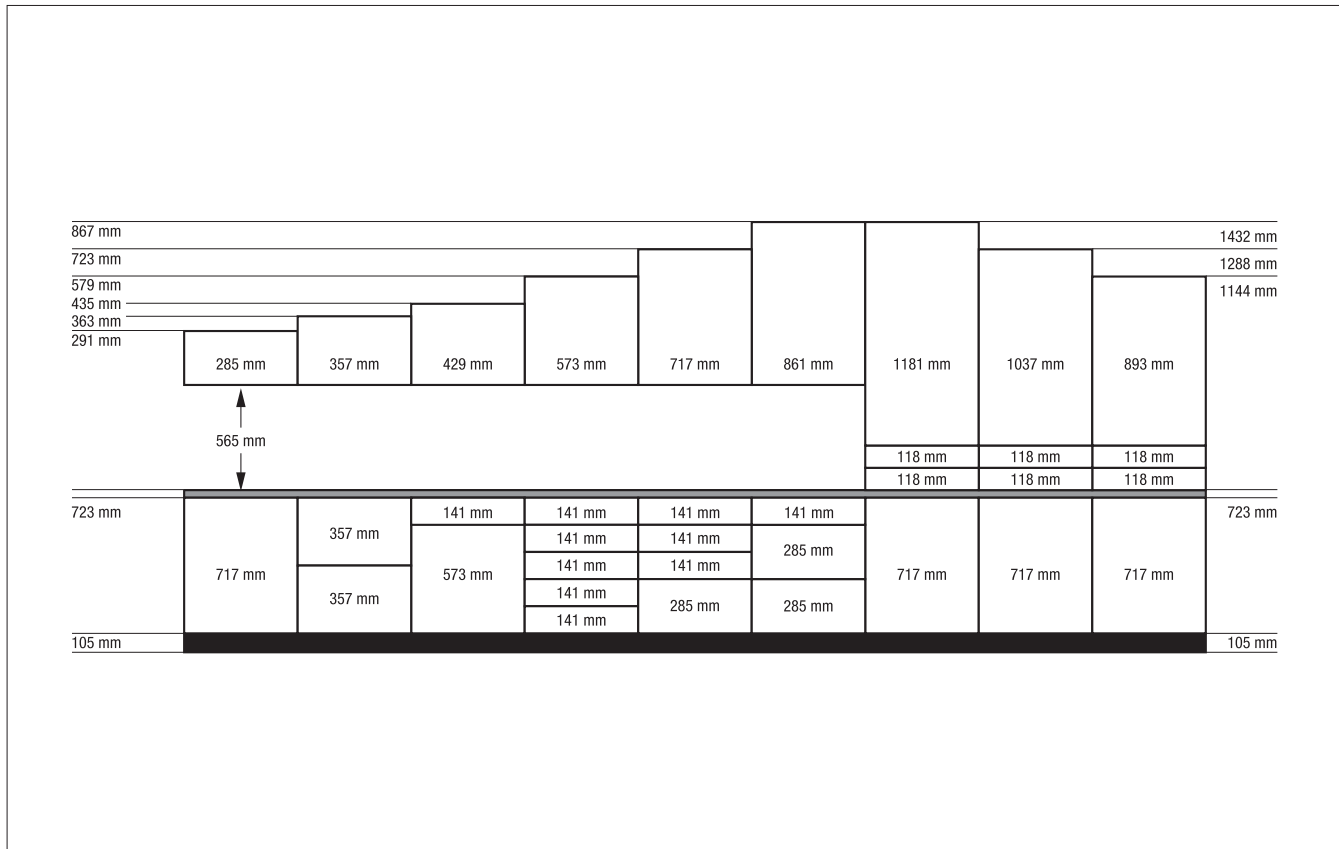

Front dimensions

Kitchens can be optimally planned with our grid system with 141 mm grid size (front drawer panel).

The elegant 3 mm join (horizontal) meets the high standards expected of consistent, design-oriented planning in every respect.

Various cabinet heights and plinth heights of 105-205 mm allow a working height of 868 to 968 mm.

The depth of the worktop is individually adjustable from 250 to 1197/ 1200 mm.

Depth reductions of cabinets are also possible.

The corresponding items are indicated with the depth reduction pictogram.

Planning options in detail:

- 6 base unit heights 291 to 867 mm
- 6 tall unit heights from 1043 to 2195 mm
- 6 wall unit heights from 291 to 867 mm
- 3 top-mounted unit heights from 1144 to 1432 mm
- 3 plinth heights from 105 to 205 mm
- Individual depth reduction of units
- Individual width reduction of units

System of measurements

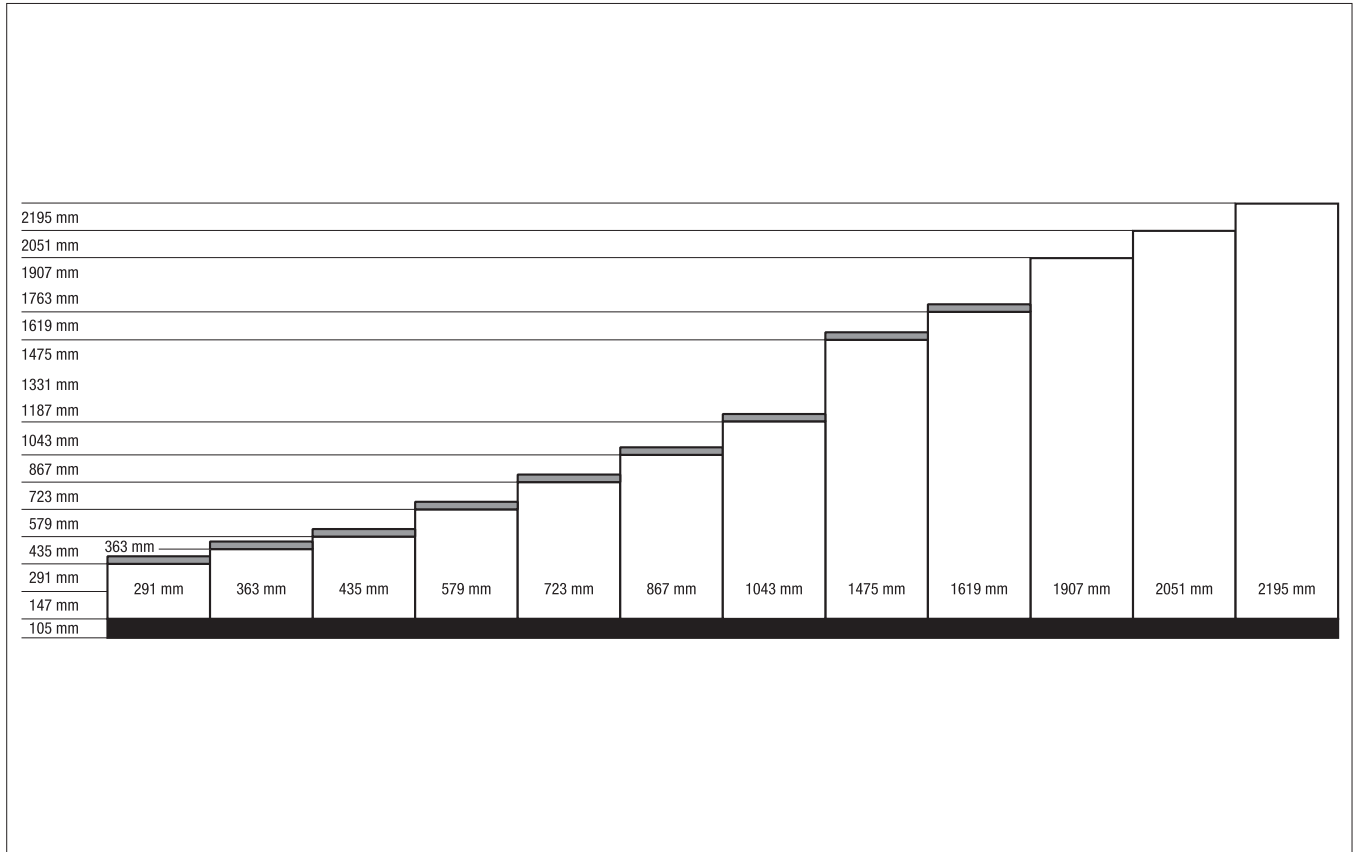

Carcase dimensions

Thanks to the 141 mm grid logic, tall units with a height of 1043 to 2195 mm fit perfectly into the overall appearance. An immense variety of niche sizes permit diversity and clever solutions when planning the built-in appliances.

Planning options in detail:

- 6 tall unit heights from 1043 to 2195 mm
- 3 plinth heights from 105 to 205 mm
- The following tilt heights apply for tall units (105 mm plinth):
 - Height of tall unit 1619 = tilt height 1820 mm
 - Height of tall unit 1907 = tilt height 2066 mm
 - Height of tall unit 2051 = tilt height 2207 mm
 - Height of tall unit 2195 = tilt height 2348 mm
- Individual width and depth reduction of storage tall units
 - The corresponding items are indicated with the depth reduction pictogram.

Warranty, rules on block regulation

Warranty

Impuls furniture is subject to the following warranty terms and conditions:

1. The warranty lasts for 2 years as from the date of delivery.
 2. The warranty covers defects which, despite careful treatment and observance of Impuls's care and installation instructions, occur during the period specified in item 1 and are proved to be the result of material or manufacturing flaws.
 3. Impuls will rectify the defect by replacement or repair at Impuls's option. Any claim under the warranty will not cover the replacement of discontinued product lines.
 4. The warranty does not cover:
 - Accessories or other parts not sold to the purchaser by Impuls but by other suppliers.
 - Normal damage from wear and tear occurring as a result of proper use, moisture, heat or movement cycles.
 - Characteristic properties typical of the product or characteristic properties of the particular material composition, e.g. variations in wood colour or texture or changes in wood that occur over the course of time.
 - Damage caused by improper assembly and installation, improper care or treatment, in particular by getting furniture too wet.
 - Damage in connection with modifications or repairs made to furniture without Impuls's explicit prior confirmation.
- Accessory components outsourced by Impuls will primarily fall under the warranty of the manufacturer producing them.
5. Delivery of replacement parts or repair does not extend the original guarantee period, nor result in a new guarantee and in particular not for replacement parts.
 6. Removal and refitting costs incurred in the process of replacing parts will be charged to the person ordering them.
 7. Impuls's terms and conditions of sale and delivery in the current version shall apply.

Block regulation

Use the advantages of block calculation for planning optimally functioning kitchens.

Your planned kitchen is calculated with the desired block order No.

The following rules apply for accounting:

- 1) All articles within a single product group are netted against one another in terms of value.

Product group 1: Wood (furniture parts, incl. item type range C and worktops)

Product group 2: Appliances/accessories

Articles in one product group cannot be netted against items in the other product group.

- 2) Price reductions are shown with 0.00 EUR in the balance of the block calculation.

- 3) Only one block can be calculated in any one commission.

- 4) Block calculation is not possible for articles which are purchased subsequently.

Details can be clarified with our regional sales manager at any time.

Item code key

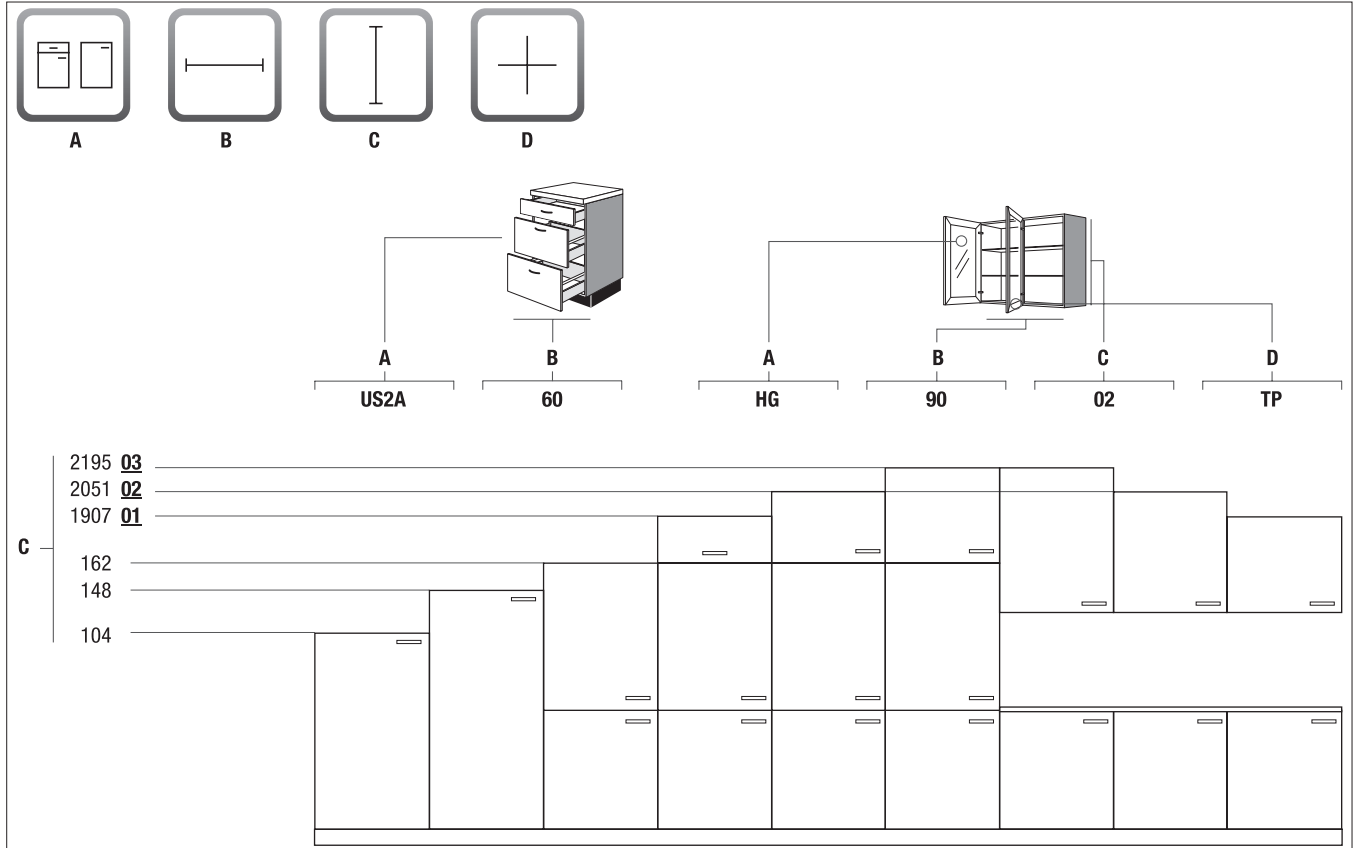

The main types of unit are divided into the main groups of

- Ubase units
- SPsink units
- Hwall units
- Atop-mounted units (may also be on worktop)
- Stall units
- Gappliance housings

Legend:

- A** = main type
- B** = width of the unit
- C** = height of the unit
- D** = special features of the unit

The item no. is composed of 4 fields. Regardless of front layout, a unit's distinguishing features are indicated at the end of the item number. This quickly narrows down the type variety in the planning programme. The finish is defined by the last digits / letters.

Notes

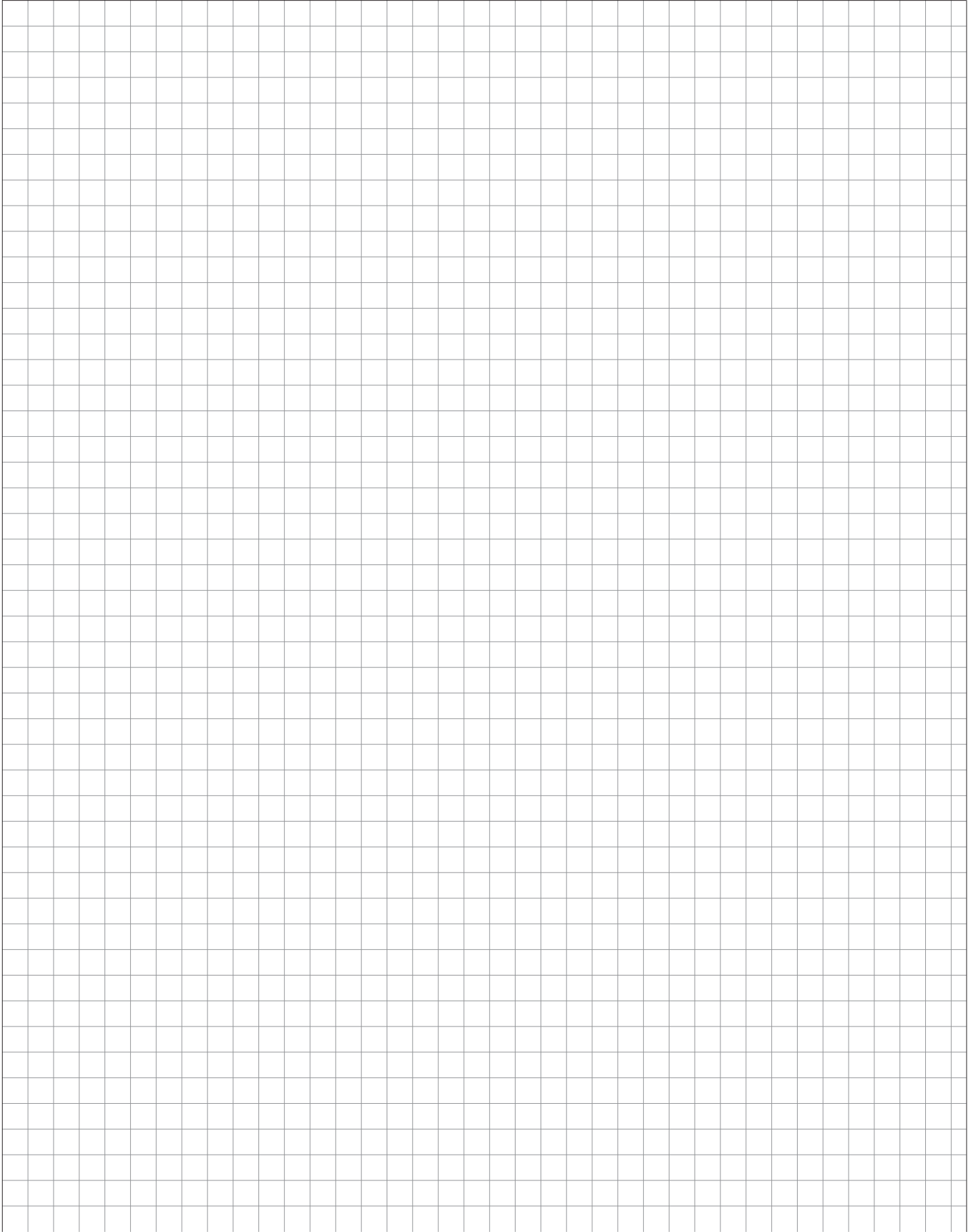

Index

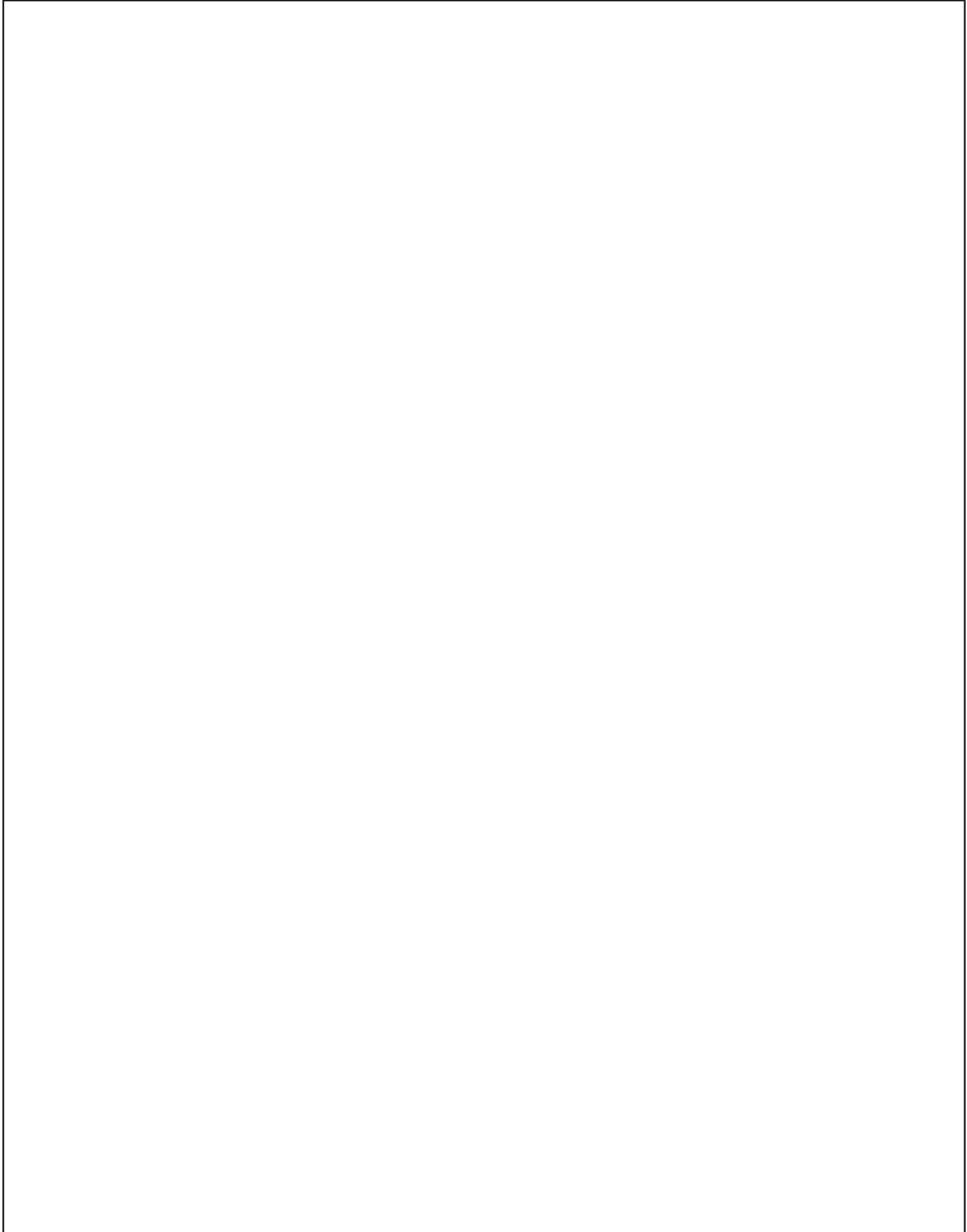

1

1-channel remote control 10.13
 1-channel remote control expansion set 10.13
 1-channel remote control starter set 10.13

2

2-way socket element 10.16

3

3-D base unit 2.27, 2.73
 3-D open shelf base unit 2.30
 3-D tall unit 4.61, 4.83, 4.108
 3-way socket element 10.16
 3-way socket with earthed plug 10.19
 3-way worktop plug socket 10.19

4

4-channel remote control 10.14

A

Accent shelf end unit 3.22, 3.34, 3.45
 Accent shelf unit 3.22-3.23, 3.34-3.35, 3.45-3.46
 Access door 4.59, 4.82, 4.106, 9.07, 9.14

Accessories for combined sealer strip 7.18
 Accessories for individual equipping 9.06, 9.14
 Accessories for snap-on cover profile 7.18
 Accessories set for sinks 03, 07
 Add-on towel rail 10.39, 2.94
 Adhesive sealing tape for worktop 10.33, 10.40, 7.20
 Angled cut for glass niche back panel 7.17
 Angled open end shelf 2.31, 3.21, 3.33, 3.44

Angled shelf 4.26, 4.44
 Angled shelf in natural oak 2.85
 Anti-tilt device for island solution 9.43
 Assembly instructions 5.159, 9.42
 Assembly/installation accessories for front connection 9.43
 AVENTOS HKS flap stay by Blum (surcharge) 3.02

B

Back panelling same as door material 6.17
 Backing strip with box 10.44, 9.21
 Baking sheet holder 10.01
 Bar handle for single or follow-up orders 9.41
 Base shelf unit 2.30, 2.32, 2.79-2.80, 5.09, 5.21
 Base unit 2.05-2.14, 2.67, 5.09, 5.12-5.16
 Base unit door 2.64
 Base unit door without stop bar 5.28
 Base unit for baguettes 2.10, 5.16
 Base unit for bottle crates 9.01
 Base unit for bottles 2.10-2.11
 Base unit for built-in appliances 2.74
 Base unit for built-under oven 2.39-2.42, 5.09, 5.22

Base unit for collecting recyclables 2.29, 9.01
 Base unit for fixed tables 2.07
 Base unit for microwave oven 2.42, 5.23
 Base unit for towels 2.11
 Base unit module 2.05, 5.108
 Base unit with glass door 2.14, 2.68
 Base unit with interior deep drawers 2.07, 5.13
 Base unit with interior drawer 2.08-2.10, 5.09, 5.14, 5.16
 Base unit with interior drawers 2.07, 2.09, 5.13
 Base unit with laundry baskets 9.01
 Base unit with pull-out table 2.13
 Base unit with Servosoft / Pro Servosoft 2.06, 2.08, 5.13-5.14
 Base unit with waste separation system 2.28, 5.17
 Bluetooth starter set 10.13
 Bottle basket 2.91
 Bracket 7.09, 7.19
 Breakfast bar 500 mm deep 7.09
 Built-in sink granite in the set 10.21-10.22
 Built-in socket element 10.18
 Built-under drawer below worktop 2.13
 Bumper bar 9.32

C

Carcase material / back panelling with thick edge, 16 mm thick 6.16-6.17
 Carcase material with thin edge, 16 mm thick 6.16
 Carcase material without edges, 16 mm thick 6.16
 Carcase rail 9.43
 Carcase tracks, full extension with Servosoft 9.31
 Carrier for interior drawer / interior deep drawer 2.08-2.10, 2.46, 2.90, 5.14, 5.16
 Carry box for cleaning agents 10.44, 9.21
 Ceiling infill panel 8.05
 Ceiling infill panels 8.05
 Child safety 10.01
 Chimney hood 3.57, 9.24, 9.26
 Clip fitting for back wall cladding 6.17
 Clip hinge, 107° opening angle 9.32
 Clip hinge, standard version 2.02, 3.02, 4.02, 5.11, 5.39, 5.62

Combined sealer strip 7.18
 Cooker power supply cable 10.40, 2.39
 Corner back panel 3.57
 Corner back panel for cooker hood 3.57
 Corner base unit 2.15-2.20, 2.22-2.26, 2.69-2.73
 Corner base unit with drawer 2.21
 Corner cut-out for glass niche back panel 7.17
 Corner filler strip for adjusting on site 2.36
 Corner hob base unit 2.47-2.48
 Corner infill panel for 135° base unit corner installations 2.36, 2.82
 Corner infill panel for base units 2.34-2.35, 2.82, 5.09, 5.33-5.34

Corner infill panel for wall units 3.25-3.26, 3.37-3.38, 3.48
 Corner plinth 8.02
 Corner sink base unit 2.59-2.63, 2.78, 5.32-5.33
 Corner wall unit 3.19-3.20, 3.32, 3.43, 5.37, 5.45
 Corner worktop 7.01-7.02, 7.05
 Corners and end caps 5.159
 Country house base shelf unit 9.23
 Country house cornice 8.04, 9.24, 9.27
 Country house end shelf unit 9.23
 Country house light pelmet 9.25, 9.28
 Country house wall shelf unit 9.23
 Cover 10.33
 Cover caps for 5 mm holes 9.44
 Cover strip for microwave aperture 5.158
 Cover strip for oven aperture 5.158
 Crossbar 2.90
 Cross-plate for clip-on hinge 9.32
 Cushioned self closing action 10.02
 Cushioning for hinged doors 2.02, 3.02, 4.02, 5.11, 5.39, 5.62

Cushioning for larder units 10.01
 Customer deliveries 9.40
 Cutlery insert 2.83-2.85
 Cut-out for glass niche back panel 7.17
 Cutout for switch/socket 7.16
 Cutout without light 58 mm in diameter 3.04-3.05, 5.41-5.42
 Cutout without light 68 mm in diameter 3.04-3.05, 5.41-5.42

D

Decor panel for appliances 2.65
 Deep drawer 9.30
 Deep drawer front 9.30
 Deep drawer unit 2.12
 Deep drawer without front 9.30
 Diagonal highboard 4.36
 Diagonal wall unit 3.20, 3.32, 3.43
 Display wall unit with unit door 3.19, 3.31, 3.42
 Display wall unit with unit doors 3.19, 3.31, 3.42
 Distance strip 7.06
 Door material infill panel for appliance housing units 4.46, 4.74-4.75, 4.98-4.99, 4.124
 Door without hinges and drillings 9.29
 Doors with fittings 9.34
 Drawer 9.30-9.31
 Drawer front 9.29, 9.31
 Drawers / deep drawers in standard finish 2.02, 4.02, 5.11, 5.61, 5.115
 Drawers / deep drawers Professional (surcharge) 2.02, 4.02, 5.11, 5.61, 5.115
 Drawers / deep drawers Professional with glass side (surcharge) 2.02, 4.02, 5.11, 5.61, 5.115
 Dresser shelf unit 3.69-3.70, 9.03

Dresser unit 3.63-3.65, 4.137-4.148, 5.104-5.111
 Dresser unit for built-in appliance 3.67-3.69
 Dresser unit with roller shutter 1144 mm high (O1 height) 3.59
 Dresser unit with roller shutter 1288 mm high (O2 height) 3.59
 Dresser unit with roller shutter 1432 mm high (O3 height) 3.59
 Dresser unit 1144 mm high (O1 height) 3.62
 Dresser unit 1288 mm high (O2 height) 3.62
 Dresser unit 1432 mm high (O3 height) 3.62
 Drill hole in glass niche back panel 7.16
 Drip tray 10.39, 2.88, 2.93
 DUPLEX 10.17

E

Edge protection for front material panel 9.44
 Electronic LED transformer 10.15
 End cap for panel shoe 5.156, 6.09, 6.13
 Energy box 10.40
 Extension cable for LED lights 10.15
 Extra charge for carcass side increased depth 9.39
 Extra charge for visible side 9.39

F

Fitting accessories for back wall covering 6.17
 Fixed front panel on plinth platform 2.76, 4.135-4.136, 4.140-4.141
 Fixing strips 10.44, 9.21
 Flap door with hinges 9.29, 9.35
 Flap holder, standard version 3.02
 Flyover shelf 8.04
 Franke 1 1/2 basin inset sink 10.32
 Franke corner inset sink 10.29
 Franke inset sink 05-06, 10.30-10.32
 Franke inset sink set 10.25
 Franke-mixer tap 08-09
 Front edge material 9.44
 Front panel 2.64, 2.77, 5.12, 5.28, 5.153, 9.29

Front panel for 600 mm wide integrated extractor 3.50
 Front panel for island plans 5.12, 5.153
 Front panel variable in dimensions 5.12, 5.153
 Front panel with 2 sides and back panel for cooker hoods 3.50
 Front without drill holes 9.36
 Front without hinges or drill holes 9.29

G

Glass door with fittings 9.34
 Glass niche back panel 7.16
 Glass shelf for wall units 9.43
 Grip ledge with up/down LED lighting 10.05, 3.03, 5.40

H

Handle for single or follow-up orders 9.41

Keyword Index

Hanging basket	2.11-2.12, 2.89, 4.22-4.23
Hanging hook rail	10.44, 9.21
Heat shield strips	10.40
Heat-protection shelf	10.39, 2.94
Highboard	4.21, 4.29-4.31, 4.35, 5.59
Highboard for brooms	4.29, 5.63, 5.117
Highboard for built-in appliances	4.24-4.25, 4.37-4.43, 4.49, 4.51
Highboard shelf unit	4.26, 4.44, 5.69, 5.122
Hinge with 155° opening angle	9.32
Hinged door with fittings	9.29, 9.33-9.34
Hob base unit	2.43-2.46, 2.49, 2.74, 5.09
Hob base unit for hob extractor	2.50-2.51, 2.75, 5.09, 5.26-5.27
Hook rail for broom cupboards	9.43
Hook rail for ceiling attachment	10.45, 9.22
Hook rail to screw onto side	10.45, 9.22
Hose extension for mixer taps	10.37
i	
iMove wall unit	3.27, 3.39
Individual frames for system shelf unit	3.10, 3.12, 3.24, 3.35, 3.46
Individual shelves for system shelf unit	3.10, 3.12, 3.24, 3.36, 3.47
Inductive charging area	7.19
Induktion cutlery insert	2.85
Infill panel base-unit side	2.36, 2.82, 5.35
Infill panel for base units	2.33-2.34, 2.81, 5.09, 5.33
Infill panel for highboard	4.27, 4.45, 4.54, 5.70, 5.122
Infill panel for highboard side	4.45, 5.70, 5.122
Infill panel for tall unit	4.54, 4.74, 4.98, 4.123, 5.82-5.83
Infill panel for tall-unit side	4.74, 4.98, 4.123, 5.83, 5.96
Infill panel for top-mounted units	3.71
Infill panel for wall units	3.10, 3.12, 3.25, 3.37, 3.48
Information for plans with standalone hobs	2.39, 2.74
Information positioning frame for flat extractors	3.51, 5.49
Insert tray	2.12, 2.89, 4.22, 4.32-4.33, 4.47
Inset sink	01-04, 10.27-10.29, 10.31
Installation accessories for built-under washing machine / dryer	9.08, 9.15
Installation set	5.158, 7.06, 9.44
Installation set unit with draining rack	3.16, 3.28, 3.40
Interior deep drawer	9.32
Interior drawer	9.31
K	
KLUDI-mixer tap	10.37
Knife block	2.83
Knife block natural oak	2.85

L	
Larder base unit	2.11, 5.09, 5.14-5.15
Laundry basket	10.43, 9.19
Laundry basket support	10.43, 9.19
LED built-in / built under spotlight	10.09
LED built-in light	10.08
LED built-in light, straight aluminium profile	10.05, 10.07, 3.04-3.05, 5.41-5.42
LED built-in spotlight	10.06-10.09, 3.03, 3.05, 5.40, 5.42
LED built-in spotlight with colour control	10.06-10.07, 3.03, 3.05, 5.40, 5.42
LED built-under light set	10.08, 10.10
LED recessed grip lighting	10.11, 5.36
Lever mixer tap	10.34-10.36
Lift-up door for microwave niche	4.27, 4.46, 4.54, 4.75, 4.99, 4.124
Limiter for energy accumulator for upward folding door units	10.02
Limiter for hinges	10.02
Longitudinal divider	2.83
Lower hinged-door with hinges	9.33
M	
Mat	2.87-2.88
Mechanical opening assistance for hinged doors	10.02
Metal cross member	9.32
Modular built in shelf unit for highboard / tall unit	4.41, 4.50, 4.69, 4.92, 4.116, 5.68
Modular panel edge	6.13
Modular panel for base unit	5.154, 6.01, 6.10
Modular panel for dresser unit	6.06, 6.11
Modular panel for highboard	5.155, 6.05, 6.11
Modular panel for tall unit	5.155, 6.04, 6.10
Modular panel for wall unit	6.07, 6.11
Modular panel in variable sizes	5.156, 6.08, 6.11-6.12
Modular panels	5.154, 6.01, 6.10
Modular shelf unit	7.13
Modular unit for raised dishwasher	4.125-4.135, 4.137-4.138
Modular unit for raised washing machine/dryer	9.08-9.10, 9.15-9.17
N	
Niche back panel	7.14-7.15
Niche back panel, variable size	7.14
Niche set	7.21
Non-slip mats (surcharge per unit)	2.02, 4.02, 5.11, 5.61, 5.115
Note:	7.10

O	
Open shelf unit for bottles ORGA-LINE division	2.32, 2.80, 2.86
P	
Panel for above recirculation cooker hood panel	3.50
Panel for island plans	5.154, 6.02-6.03, 6.10
Panel for raised washing machine/dryer	9.18
Panel shoe	5.156, 6.09, 6.13
Paper roll holder	10.44, 9.21
PICCOLINO	10.18
Pilaster for base unit	9.24, 9.26
Pilaster for highboard / tall unit	9.24, 9.27
Pilaster for wall unit	9.24, 9.26
Planning advice	10.05, 3.03, 5.40
Plinth base with plinth feet	2.76
Plinth connecting profile	8.02
Plinth corner profile stainless steel effect	8.02
Plinth foot	9.44
Plinth foot glider set	9.44
Plinth foot slide	9.44
Plinth lighting set	10.11
Plinth panel	8.01
Plinth panel and side plinth	8.03
Plinth panel stainless steel-effect	8.01
Plinth panel version	8.01
Plinth platform without plinth feet	2.76, 4.135, 4.137-4.138
Plinth trim gloss	8.01
Plinth trim gloss, side	8.02-8.03, 9.01, 9.04, 9.11
Protective strips	10.39
Pull-out larder highboard	4.22-4.23, 4.32-4.34, 5.59, 5.64
Pull-out tall unit	4.47, 4.57-4.58, 4.80-4.81
Pyramis inset round sink	10.30
Pyramis inset sink	10.30-10.32
Pyramis inset sink set	10.23-10.24, 10.26
Q	
Quick delivery service	9.40
R	
Recess back panel with groove profile	9.25
Recessed grip	5.122, 5.133, 5.147, 5.151
Recyclable waste collector	10.43, 9.19
Rounded edges on glass niche back panels	7.17
Rounding off	7.10
S	
Screw-on holder	10.45, 9.22
Screw-on utensils box	10.45, 9.22
Sealer strip	7.12
Sealer strip accessories	7.12
Semicircular rounding	7.11
Sensor mixer tap	10.36
Set of 3	10.10-10.11
Set of 3 LED triangular lights	10.10

Set of 5 LED triangular lights	10.10
Set of plinth feet	9.44
Set of spice jars	10.01, 2.83
Shelf	6.14
Shelf end unit, angled	2.30, 2.79, 3.21, 3.33, 3.44
Shelf for base units, highboards and tall units	9.42
Shelf for corner wall unit	9.43
Shelf for wall shelf unit	9.43
Shelf for wall units	9.42
Shelf rail	10.01
Shelf supports	6.15, 7.20
Side panels	2.90
Side return plinth panel	8.01-8.03, 9.01, 9.04, 9.11
Side support panel	2.37
Single socket	10.16
Sink base unit	2.52-2.59, 2.78, 5.09, 5.28-5.32
Snap-on cover profile for combi-sealer strip	7.18
Soft close for hinged doors	10.01-10.02
Space-saving waste and trap assembly	10.33, 10.41, 2.93
Spice jar holder	10.01, 2.83
Storage surface	10.44, 9.21
Storage surface with rail	10.44, 9.21
Straight worktop edge 1.4 mm ABS without heat-seal adhesive	7.11
Strip handle for single or follow-up orders	9.42
Suitable additions:	10.28-10.29, 2.08-2.12, 2.46
Supplement for pre-fitted sinks or hobs	9.42
Supplement PLR worktop with slanted cut	7.10
Support bracket for breakfast bar	7.19
Support leg for worktop tables	7.19
Supporting frames for bottle crates, individual	10.43, 9.05, 9.13, 9.19
Surcharge Angled cut with ABS edge	7.10
Surcharge Corner cut-out with ABS edge	7.11
Surcharge Corner cut-out without edge	7.11
Surcharge for depth reduction	9.38
Surcharge for flat-pack or unglued pre-assembled cabinets	9.39
Surcharge for pre-routing cutout for built-in sinks and hobs	7.10
Surcharge for recessed grip milling for induction hobs	5.22-5.25, 5.159
Surcharge for round fixed table top	7.09
Surcharge for special worktops	7.11
Surcharge for width reduction	9.37-9.38
Surcharge PLR edge on right/left side	7.11
Surcharge PLS worktop with rounded front edge	7.11
Surcharge Rounded corner	7.10
Surcharge Worktop corner joint	7.10
Surcharge Worktop corner joint, mitred	7.10
Surcharge Worktop depth reduction	7.11

Surcharge Worktop with ABS edge at the back	7.11	Wall unit with glass flap door	3.11, 5.37, 5.43
Surface-mounted switch	10.15	Wall unit with laundry baskets	9.06, 9.13
System shelf unit	3.10, 3.12, 3.24, 3.35, 3.46	Wall unit with lift-up door	3.15, 5.37, 5.44
T		Waste and trap assembly	07
Tall broom cupboard	4.55, 4.77, 4.101, 5.123, 5.134	Waste bin	2.92
Tall end shelf unit	4.53, 4.73, 4.97, 4.122	Waste recycling system	2.93
Tall shelf unit	4.53, 4.73, 4.97, 4.122, 5.82, 5.95	Waste separation system	2.92
Tall unit	4.47, 4.55-4.56, 4.58-4.59	Waterproof plinth seal	8.02
Tall unit for appliances	4.48-4.52, 4.62-4.72, 4.84-4.96	Wire shelf for broom cupboards	9.43
Tall unit for bottle crates	9.05, 9.13	Worktop	7.02-7.03, 7.05
Tall unit for crockery	4.102, 5.71, 5.84	Worktop D-Profile	7.01
Tall unit for individual equipping	4.56, 4.80, 4.104, 5.124, 5.135		
Tall unit for shoes	9.06, 9.13		
Top box for tall units	3.60, 4.60		
Top panel for highboard / tall unit	5.155, 6.08-6.09, 6.12		
Top panel for wall unit	6.08, 6.12		
Top panel with angled cut for highboard / tall unit	6.09, 6.12-6.13		
Top-mounted unit for oven	3.65-3.66, 4.148		
Top-mounted unit with roller shutter door and pull-out shelf	3.60-3.61		
Touch LED Emotion expansion set	10.12		
Touch LED Emotion starter set	10.12		
Towel rail	2.90		
U			
Unit rear panel	9.33		
Universal holder for broom cupboards	9.43		
Upper hinged door with fittings	9.33		
V			
Valve set to retrofit	03-04		
Vapour guard	10.40, 2.64, 2.77, 5.157		
Ventilation grille for plinth panel	8.02		
Ventilation grille for worktops	7.20		
W			
Wall open shelf unit	3.09, 3.11, 3.13, 3.21, 3.33, 3.44		
Wall unit	3.09, 3.11, 3.13, 3.15, 3.19, 3.27		
Wall unit for microwaves	3.49-3.50, 5.37, 5.49		
Wall unit for telescopic cooker hood	3.51-3.56, 5.37, 5.49-5.51		
Wall unit with bar flap door	3.11		
Wall unit with draining rack	3.16, 3.28, 3.40		
Wall unit with folding door	3.18-3.19, 3.30-3.31, 5.37, 5.44		
Wall unit with glass door	3.16, 3.18, 3.28, 3.30, 3.40, 3.42		
Wall unit with glass doors	3.17-3.18, 3.29-3.30, 3.41-3.42		

Keyword Index

1. Summary of ranges

- Summary of doors
- Price Index
- Doors
- Glass types
- Carcase colours
- Colours of visible sides
- Plinth colours
- Plinth colours
- Glass niche back panel
- Niche back panel motifs
- Panel colours
- Worktop finishes
- Summary of handles



Doors

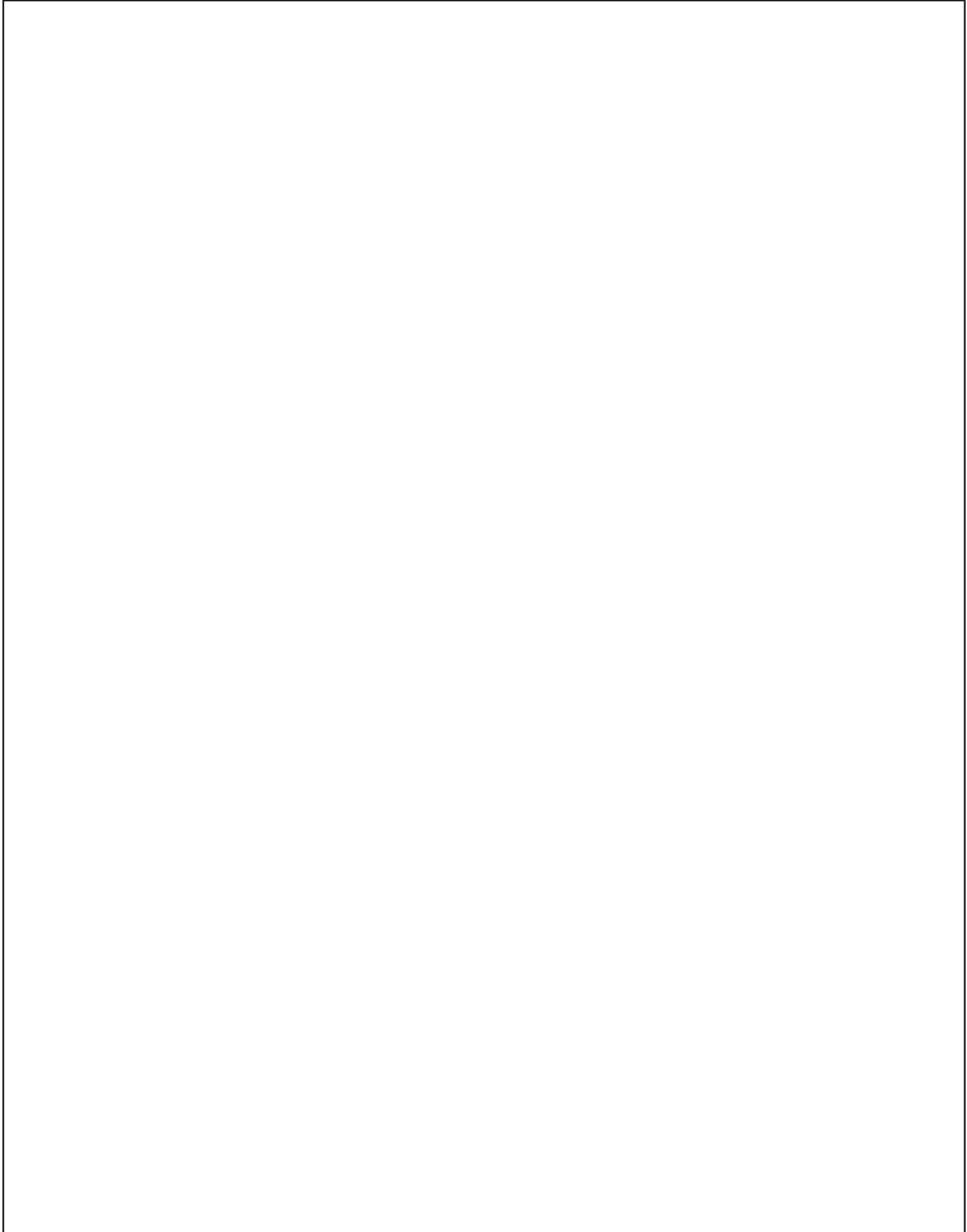

Summary of doors

PG 1 IP 1200

No. 111 Light oak effect
 No. 773 vintage oak effect
 No. 628 white
 No. 748 magnolia white
 No. 921 pebble grey
 No. 112 Cappuccino

PG 1 IP 1200

No. 133 Volcano brown
 No. 158 Sage green **NEW**
 No. 952 Petrol
 No. 121 Thyme
 No. 134 Alby Blue
 No. 954 Space grey

PG 1 IP 1200

No. 132 Slate grey
 No. 913 graphite
 No. 945 Concrete look slate grey light
 No. 923 Concrete effect, natural
 No. 932 Concrete effect slate dark grey

PG 2 IP 2200

No. 123 Light oak effect
 No. 141 Light oak effect Horizontal wood grain
 No. 162 Summerfield oak effect **NEW**
 No. 163 Summerfield oak effect Horizontal wood grain **NEW**
 No. 137 vintage oak effect
 No. 138 vintage oak effect Horizontal wood grain

The finish is offset if there are several doors on one and the same cabinet.

Summary of doors

PG 2 IP 2200

No. 946 Oregon oak effect
 No. 142 Oregon oak effect Horizontal wood grain
 No. 114 Oak effect black
 No. 143 Oak effect black Horizontal wood grain
 No. 154 white
 No. 155 magnolia white

PG 2 IP 2200

No. 159 Sage green **NEW**
 No. 136 Volcano brown
 No. 161 Space grey **NEW**
 No. 135 Slate grey

PG 3 IP 3150

No. 167 white **NEW**
 No. 168 magnolia white **NEW**

PG 3 IP 3150

No. 169 pebble grey **NEW**
 No. 171 Cappuccino **NEW**
 No. 145 Volcano brown
 No. 164 Sage green **NEW**
 No. 172 Space grey **NEW**
 No. 144 Slate grey

PG 3 IP 3150

No. 157 graphite
 No. 156 Black
 No. 791 high-gloss white

PG 3 IP 4050

No. 792 high-gloss magnolia white
 No. 937 high-gloss pebble grey
 No. 924 high-gloss red











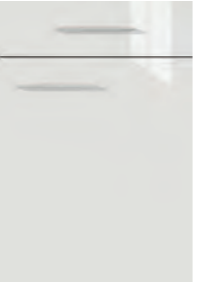

The finish is offset if there are several doors on one and the same cabinet.

Summary of doors

- A** **Front class A**
Front colours in which panels, carcass and plinth panels are available.
- B** **Front class B**
Front colours in which panels are available.
- C** **Symbol Range C / handleless**
Fronts that are also possible in Range C / handleless

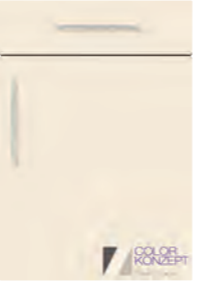
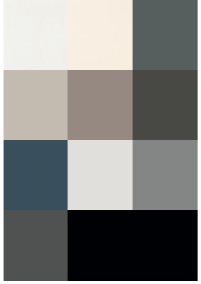
1.02 The finish is offset if there are several doors on one and the same cabinet.

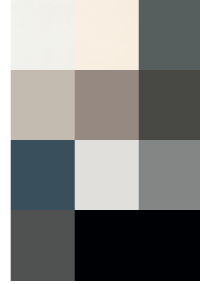
Summary of doors

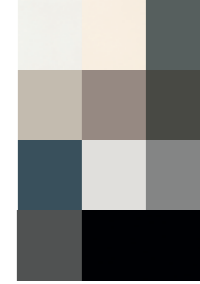
PG 3 IP 4050		PG 4 IP 4250			
					
No. 115 high-gloss space grey C A	No. 939 high-gloss graphite C A	No. 786 white A	No. 787 magnolia white A	No. 957 Space grey A	No. 956 graphite A
PG 4 IP 4820		PG 5 IP 6500	PG 6 IP 7500		
					
No. 943 white A		No. 723 high-gloss white A	No. 173 high-gloss white A NEW		
PG 6 IP 6800 CK		PG 7 IP 7810 CK		PG 7 IP 7820 CK	
					
No. 391 Substrate smooth	11 colours	No. 397 Carrier country house modern NEW	11 colours	No. 394 Carrier country house classico	11 colours

The finish is offset if there are several doors on one and the same cabinet.

Price Index

Price group	Range	Range no.	Index	Page
1	IP 1200	512	61	1.04 - 1.07
2	IP 2200	560	66	1.08 - 1.10
3	IP 3150	572	69	1.11 - 1.12
3	IP 4050	570	69	1.13 - 1.14
4	IP 4250	567	74	1.15
4	IP 4820	583	74	1.16
5	IP 6500	559	81	1.17
6	IP 7500	569	88	1.18
6	IP 6800 CK	578	88	1.19
7	IP 7810 CK	580	97	1.20
7	IP 7820 CK	581	97	1.21

A regular L-shaped kitchen layout, without appliances and accessories and including a PLR worktop has been used as a basis for this index. Our programme IP 1200 with a price factor of 61 allows a comparison to other price groups.

Information on the range

Door: Support panel with all-round, slightly rounded edges.
Surface melamine resin coated.

Door thickness: 16 mm

Information concerning the door:
Handle assembly on wooden doors:
Standard: horizontal
Optional: horizontal centred or vertical

Glass types

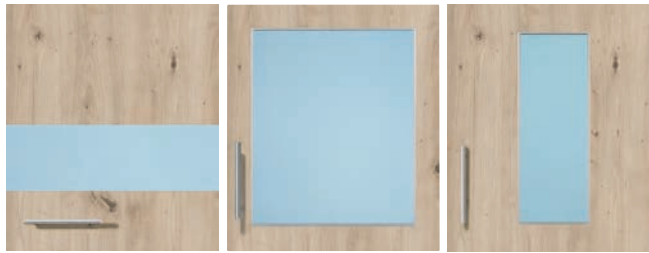

Segmented glass door in front colour No. 706
Note the available glass choices. D-handles can only be installed horizontally. Bar handles can only be installed vertically.

Framed glass door in front colour No. 701
Stainless steel coloured glass retaining profile on both sides. Note the available glass choices. D-handles and bar handles can only be mounted vertically.

Framed glass door in front colour with narrow glass No. 704
Stainless steel coloured glass retaining profile on both sides. Note the available glass choices. D-handles and bar handles can only be mounted vertically.



No. 111 Light oak effect



No. 773 vintage oak effect



Information on the range

Door: Support panel with all-round, slightly rounded edges.
Surface melamine resin coated.

Door thickness: 16 mm

Information concerning the door:
Handle assembly on wooden doors:
Standard: horizontal
Optional: horizontal centred or vertical

Glass types

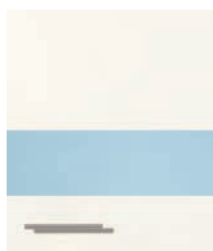

Segmented glass door in front colour No. 706
Note the available glass choices. D-handles can only be installed horizontally. Bar handles can only be installed vertically.



Framed glass door in front colour No. 701
Stainless steel coloured glass retaining profile on both sides. Note the available glass choices. D-handles and bar handles can only be mounted vertically.



Framed glass door in front colour with narrow glass No. 704
Stainless steel coloured glass retaining profile on both sides. Note the available glass choices. D-handles and bar handles can only be mounted vertically.

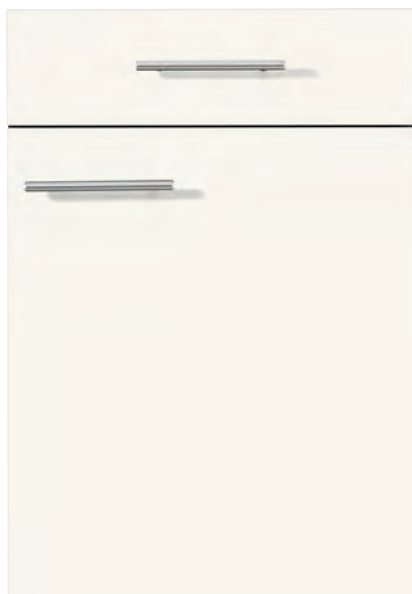

No. 628 white



No. 748 magnolia white

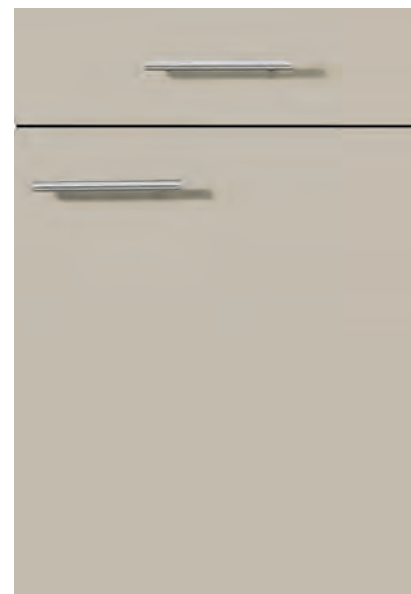

No. 921 pebble grey



No. 112 Cappuccino

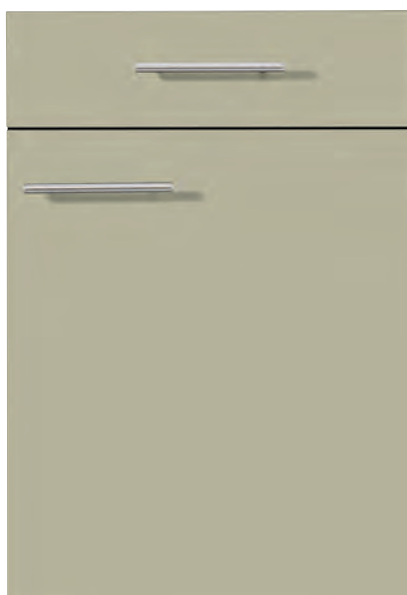

No. 158 Sage green



No. 133 Volcano brown



NEW

Nb. = effect; Kst. = plastic; options for handle arrangements on doors: H = horizontal V = vertical M = middle

Information on the range

Door: Support panel with all-round, slightly rounded edges.
Surface melamine resin coated.

Door thickness: 16 mm

Information concerning the door:
Handle assembly on wooden doors:
Standard: horizontal
Optional: horizontal centred or vertical

Glass types



Segmented glass door in front colour No. 706
Note the available glass choices. D-handles can only be installed horizontally. Bar handles can only be installed vertically.



Framed glass door in front colour No. 701
Stainless steel coloured glass retaining profile on both sides. Note the available glass choices. D-handles and bar handles can only be mounted vertically.



Framed glass door in front colour with narrow glass No. 704
Stainless steel coloured glass retaining profile on both sides. Note the available glass choices. D-handles and bar handles can only be mounted vertically.

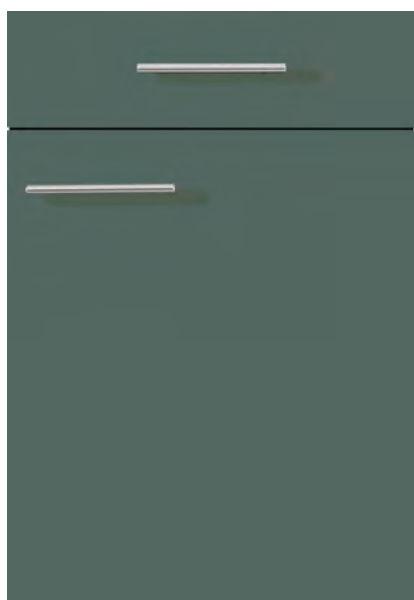

No. 121 Thyme

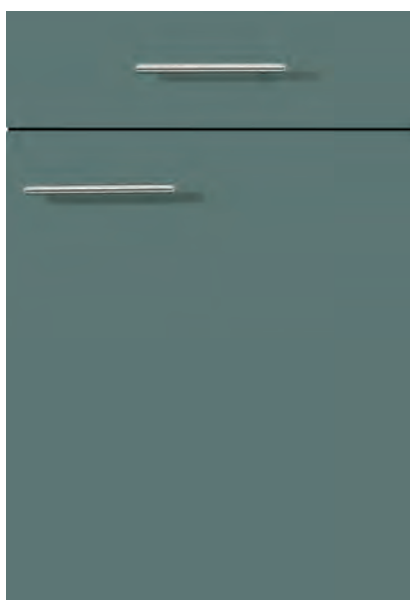

No. 952 Petrol

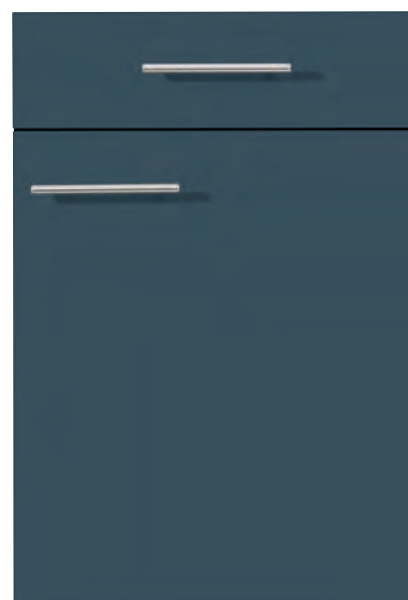

No. 134 Alby Blue

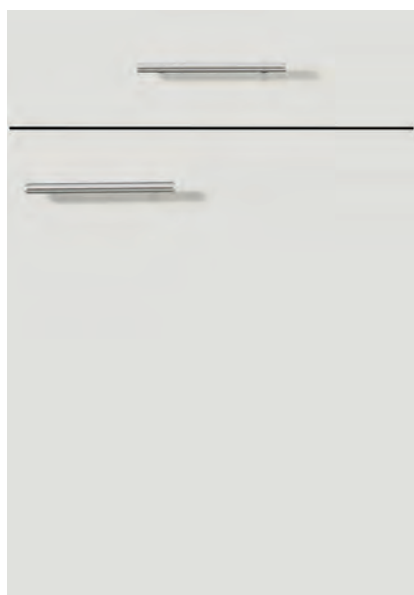

No. 954 Space grey



No. 132 Slate grey

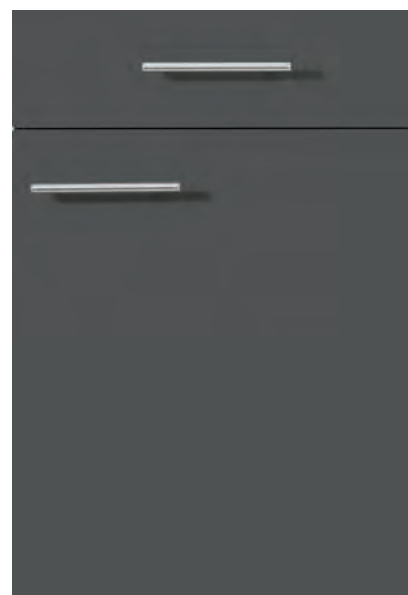

No. 913 graphite



Information on the range

Door: Support panel with all-round, slightly rounded edges.
Surface melamine resin coated.

Door thickness: 16 mm

Information concerning the door:
Handle assembly on wooden doors:
Standard: horizontal
Optional: horizontal centred or vertical

Glass types

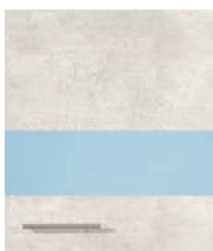

Segmented glass door in front colour No. 706
Note the available glass choices. D-handles can only be installed horizontally. Bar handles can only be installed vertically.



Framed glass door in front colour No. 701
Stainless steel coloured glass retaining profile on both sides. Note the available glass choices. D-handles and bar handles can only be mounted vertically.



Framed glass door in front colour with narrow glass No. 704
Stainless steel coloured glass retaining profile on both sides. Note the available glass choices. D-handles and bar handles can only be mounted vertically.



No. 945 Concrete look slate grey light  **B**



No. 923 Concrete effect, natural  **B**



No. 932 Concrete effect slate dark grey  **B**

Information on the range

Door: Support panel with all-round, slightly rounded edges.
Surface melamine resin coated.

Door thickness: 19 mm

Information concerning the door:
Handle assembly on wooden doors:
Standard: horizontal
Optional: horizontal centred or vertical

Glass types

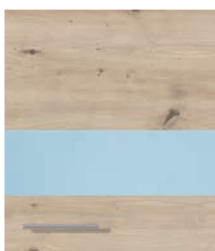

Segmented glass door in front colour No. 706
Note the available glass choices. D-handles can only be installed horizontally. Bar handles can only be installed vertically.



Framed glass door in front colour No. 701
Stainless steel coloured glass retaining profile on both sides. Note the available glass choices. D-handles and bar handles can only be mounted vertically.

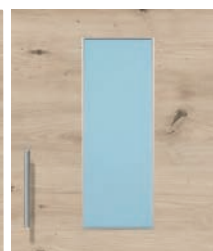

Framed glass door in front colour with narrow glass No. 704
Stainless steel coloured glass retaining profile on both sides. Note the available glass choices. D-handles and bar handles can only be mounted vertically.



No. 141 Light oak effect
Horizontal wood grain



No. 123 Light oak effect

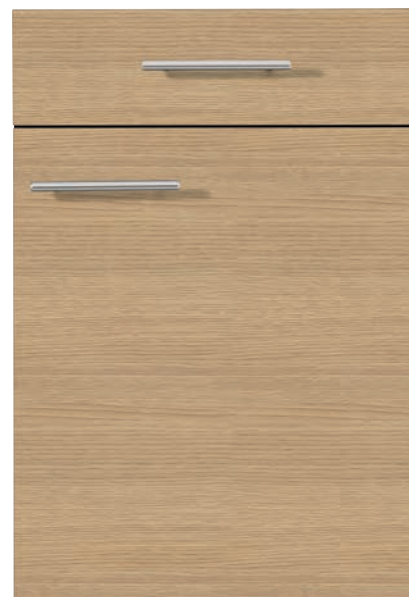

No. 163 Summerfield oak effect
Horizontal wood grain



NEW

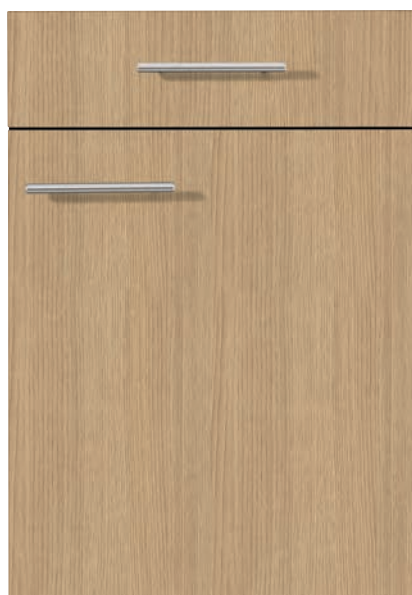

No. 162 Summerfield oak effect



NEW



No. 138 vintage oak effect
Horizontal wood grain



No. 137 vintage oak effect



Information on the range

Door: Support panel with all-round, slightly rounded edges.
Surface melamine resin coated.

Door thickness: 19 mm

Information concerning the door:
Handle assembly on wooden doors:
Standard: horizontal
Optional: horizontal centred or vertical

Glass types

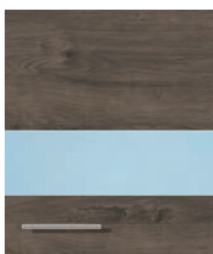

Segmented glass door in front colour No. 706
Note the available glass choices. D-handles can only be installed horizontally. Bar handles can only be installed vertically.



Framed glass door in front colour No. 701
Stainless steel coloured glass retaining profile on both sides. Note the available glass choices. D-handles and bar handles can only be mounted vertically.



Framed glass door in front colour with narrow glass No. 704
Stainless steel coloured glass retaining profile on both sides. Note the available glass choices. D-handles and bar handles can only be mounted vertically.



No. 142 Oregon oak effect
Horizontal wood grain

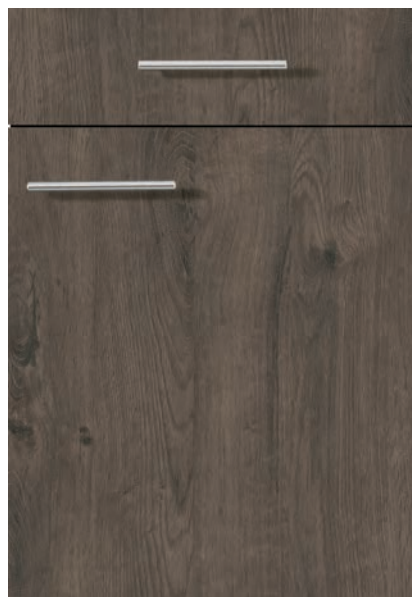

No. 946 Oregon oak effect

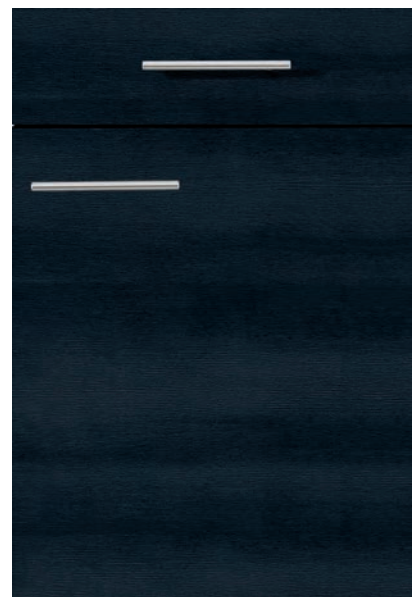

No. 143 Oak effect black
Horizontal wood grain



No. 114 Oak effect black



Information on the range

Door: Support panel with all-round, slightly rounded edges.
Surface melamine resin coated.

Door thickness: 19 mm

Information concerning the door:
Handle assembly on wooden doors:
Standard: horizontal
Optional: horizontal centred or vertical

Glass types



Segmented glass door in front colour No. 706
Note the available glass choices. D-handles can only be installed horizontally. Bar handles can only be installed vertically.

Framed glass door in front colour No. 701
Stainless steel coloured glass retaining profile on both sides. Note the available glass choices. D-handles and bar handles can only be mounted vertically.

Framed glass door in front colour with narrow glass No. 704
Stainless steel coloured glass retaining profile on both sides. Note the available glass choices. D-handles and bar handles can only be mounted vertically.

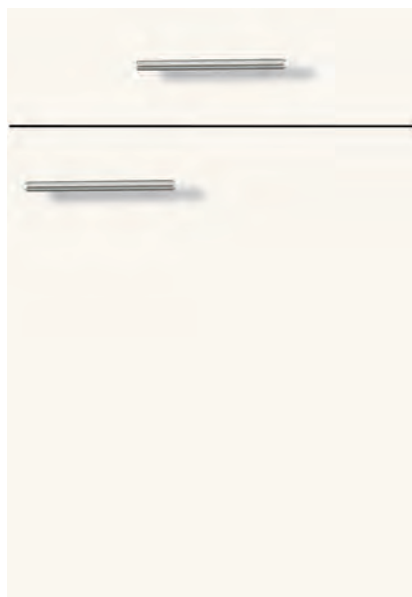

No. 154 white

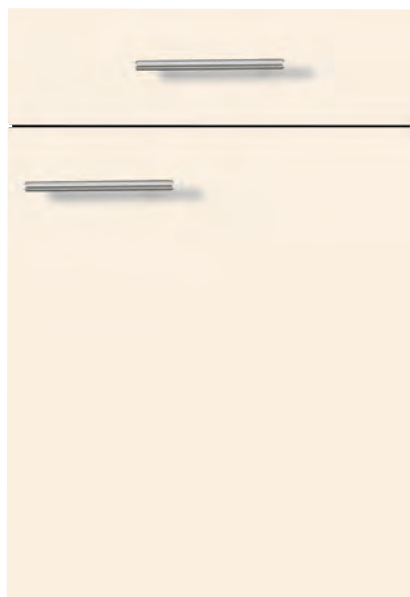

No. 155 magnolia white

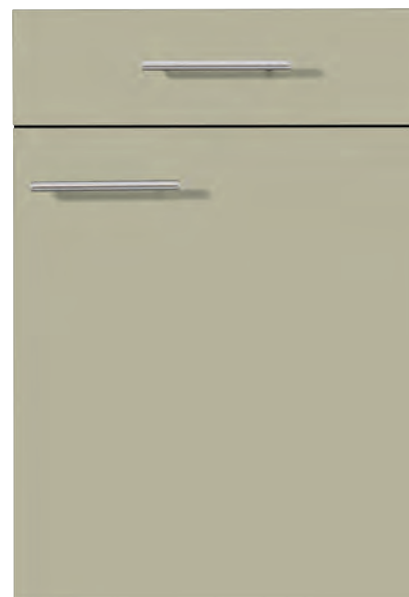

No. 159 Sage green



NEW

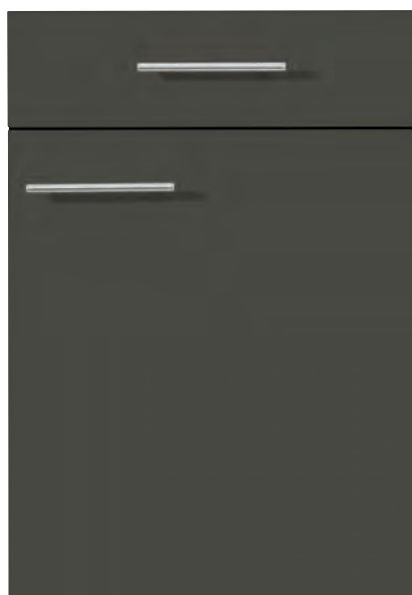

No. 136 Volcano brown



No. 161 Space grey



No. 135 Slate grey



NEW

Information on the range

Door: Support panel with all-round, slightly rounded edges.
Surface matt lacquered.

Door thickness: 19 mm

Information concerning the door:
Handle assembly on wooden doors:
Standard: horizontal
Optional: horizontal centred or vertical

Glass types

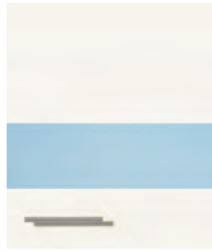

Segmented glass door in front colour No. 706
Note the available glass choices. D-handles can only be installed horizontally. Bar handles can only be installed vertically.

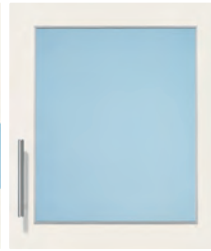

Framed glass door in front colour No. 701
Stainless steel coloured glass retaining profile on both sides. Note the available glass choices. D-handles and bar handles can only be mounted vertically.



Framed glass door in front colour with narrow glass No. 704
Stainless steel coloured glass retaining profile on both sides. Note the available glass choices. D-handles and bar handles can only be mounted vertically.

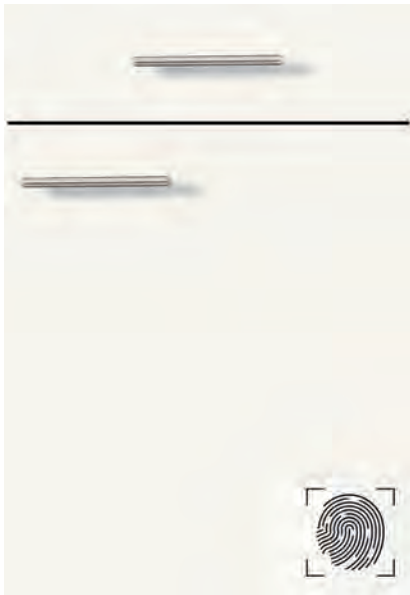

No. 167 white

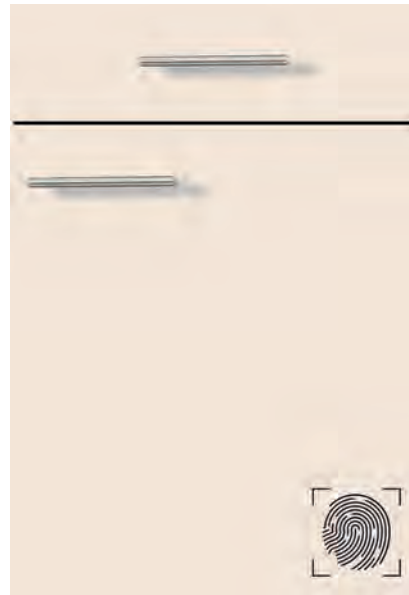

No. 168 magnolia white



No. 169 pebble grey



No. 171 Cappuccino

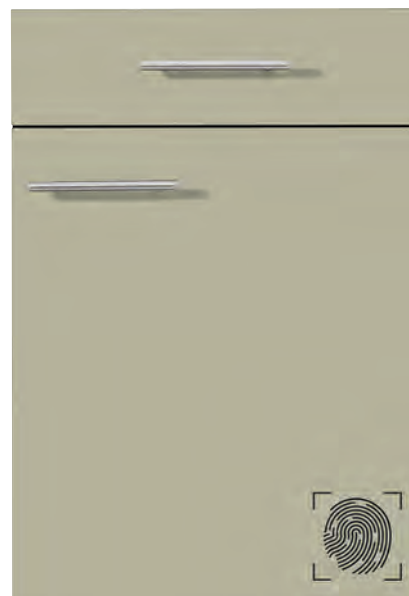

No. 164 Sage green



No. 145 Volcano brown

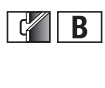

Nb. = effect; Kst. = plastic; options for handle arrangements on doors: H = horizontal V = vertical M = middle

Information on the range

Door: Support panel with all-round, slightly rounded edges.
Surface matt lacquered.

Door thickness: 19 mm

Information concerning the door:
Handle assembly on wooden doors:
Standard: horizontal
Optional: horizontal centred or vertical

Glass types

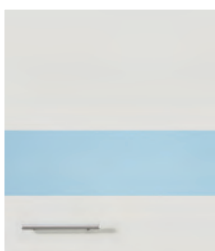

Segmented glass door in front colour No. 706
Note the available glass choices. D-handles can only be installed horizontally. Bar handles can only be installed vertically.



Framed glass door in front colour No. 701
Stainless steel coloured glass retaining profile on both sides. Note the available glass choices. D-handles and bar handles can only be mounted vertically.

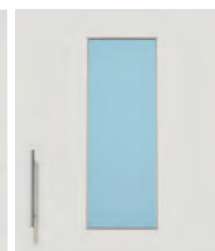

Framed glass door in front colour with narrow glass No. 704
Stainless steel coloured glass retaining profile on both sides. Note the available glass choices. D-handles and bar handles can only be mounted vertically.

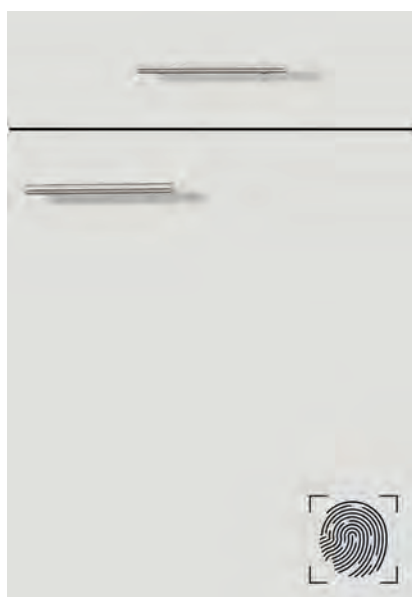

No. 172 Space grey



NEW



No. 144 Slate grey

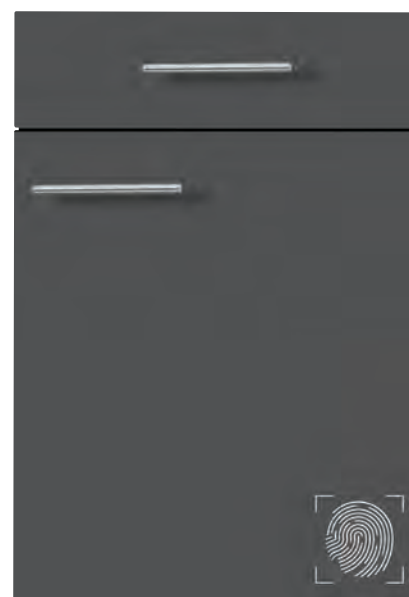

No. 157 graphite

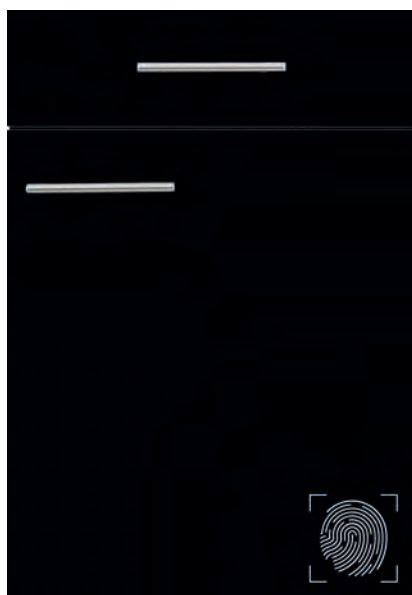

No. 156 black



Information on the range

Door: Support panel with all-round, slightly rounded high-gloss edges.
Surface high-gloss lacquered.

Door thickness: 19 mm

Information concerning the door:
Handle assembly on wooden doors:
Standard: horizontal
Optional: horizontal centred or vertical

Glass types



Segmented glass door in front colour No. 706
Note the available glass choices. D-handles can only be installed horizontally. Bar handles can only be installed vertically.

Framed glass door in front colour No. 701
Stainless steel coloured glass retaining profile on both sides. Note the available glass choices. D-handles and bar handles can only be mounted vertically.

Framed glass door in front colour with narrow glass No. 704
Stainless steel coloured glass retaining profile on both sides. Note the available glass choices. D-handles and bar handles can only be mounted vertically.

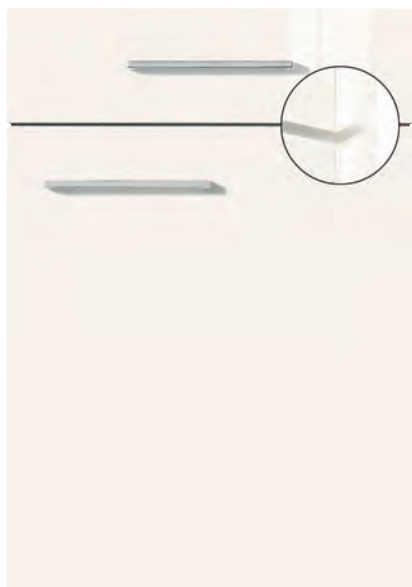

No. 791 high-gloss white



No. 792 high-gloss magnolia white



No. 937 high-gloss pebble grey



No. 924 high-gloss red



Information on the range

Door: Support panel with all-round, slightly rounded high-gloss edges.
Surface high-gloss lacquered.

Door thickness: 19 mm

Information concerning the door:
Handle assembly on wooden doors:
Standard: horizontal
Optional: horizontal centred or vertical

Glass types



Segmented glass door in front colour No. 706
Note the available glass choices. D-handles can only be installed horizontally. Bar handles can only be installed vertically.

Framed glass door in front colour No. 701
Stainless steel coloured glass retaining profile on both sides. Note the available glass choices. D-handles and bar handles can only be mounted vertically.

Framed glass door in front colour with narrow glass No. 704
Stainless steel coloured glass retaining profile on both sides. Note the available glass choices. D-handles and bar handles can only be mounted vertically.



No. 115 high-gloss space grey  **A**

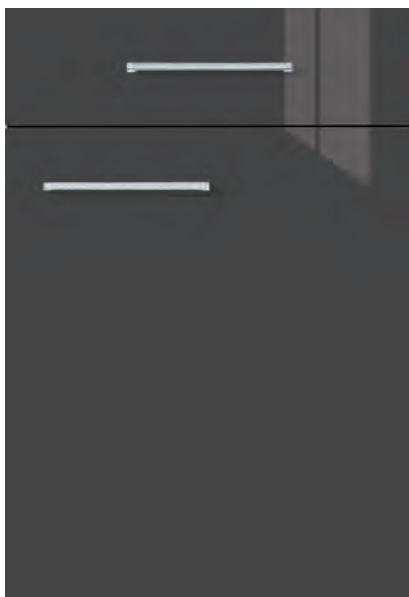

No. 939 high-gloss graphite  **B**

Information on the range

Door: Support panel with all-round small radius.
Moulded frame.
Surface foil-wrapped.
Door thickness: 19 mm

Information concerning the door:

Handle assembly on wooden doors:

Standard: vertical
Optional: horizontal centred
Centre-positioned handle 783 is not possible.
Front components with frames and/or profiling are only available from a height of 285 mm.
Dimensions below that will be made as smooth fronts.

Glass types

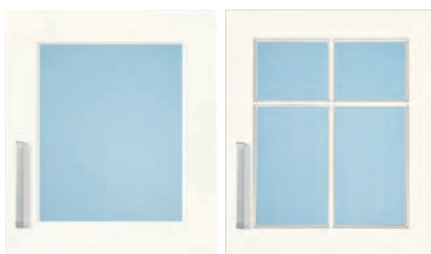

Framed glass door in front colour No. 701
Note the available glass choices.

Glass door with glazing bars in front colour No. 705
Note the available glass choices.

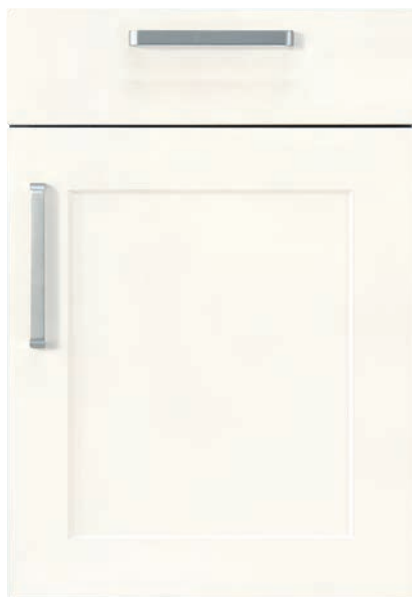

No. 786 white



No. 787 magnolia white



No. 957 Space grey



No. 956 graphite



Information on the range

Door: Support panel with all-round small radius.
Surface matt lacquered.
Door thickness: 19 mm

Information concerning the door:
Handleless

Standard worktop depth should only be 590 mm (instead of 600 mm). In this range, no surcharge is made on reduction to standard depth (590 mm).
Corner infill panels are supplied as smooth front components (without a grip recess).

Glass types



Segmented glass door in front colour No. 706
Note the available glass choices. D-handles can only be installed horizontally.
Bar handles can only be installed vertically.



Framed glass door in front colour No. 701
Note the available glass choices.

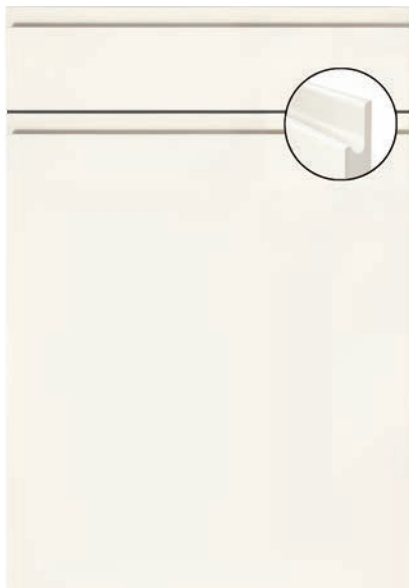

No. 943 white



Information on the range

Door: Support panel with all-round small radius.
Surface high-gloss lacquered.

Door thickness: 19 mm

Information concerning the door:
Handle assembly on wooden doors:
Standard: horizontal
Optional: horizontal centred or vertical

Glass types



Segmented glass door in front colour No. 706
Note the available glass choices. D-handles can only be installed horizontally. Bar handles can only be installed vertically.



Framed glass door in front colour no. 701
Stainless steel coloured glass retaining profile on both sides. Note the available glass choices.



Framed glass door in front colour with narrow glass No. 704
Stainless steel coloured glass retaining profile on both sides. Note the available glass choices. D-handles and bar handles can only be mounted vertically.



No. 723 high-gloss white

A

Information on the range

Door: Support panel with all-round small radius.
Surface high-gloss lacquered.
Door thickness: 19 mm

Information concerning the door:
Handleless

Standard worktop depth should only be 590 mm (instead of 600 mm). In this range, no surcharge is made on reduction to standard depth (590 mm).
Corner infill panels are supplied as smooth front components (without a grip recess).

Glass types



Segmented glass door in front colour No. 706
Note the available glass choices. D-handles can only be installed horizontally.
Bar handles can only be installed vertically.



Framed glass door in front colour No. 701
Note the available glass choices.

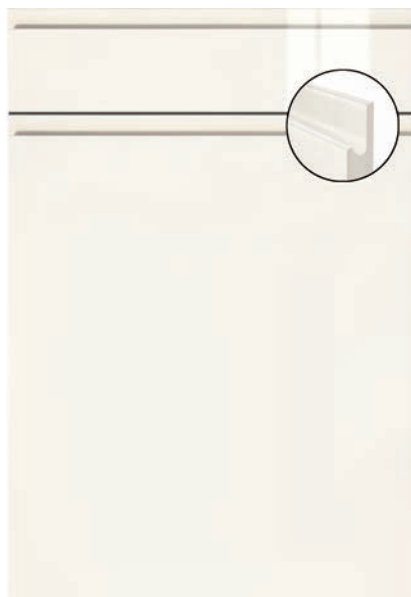

No. 173 high-gloss white

A
NEW

Information on the range

Door: Support panel with all-round small radius.
Surface matt lacquered.

Door thickness: 19 mm

Information concerning the door:
Handle assembly on wooden doors:
Standard: horizontal
Optional: horizontal centred or vertical

The express delivery services are not available for this range.

Glass types



Segmented glass door in front colour No. 706
Note the available glass choices. D-handles can only be installed horizontally. Bar handles can only be installed vertically.



Framed glass door in front colour No. 701
Note the available glass choices.



Framed glass door in front colour with narrow glass No. 704
Stainless steel coloured glass retaining profile on both sides. Note the available glass choices. D-handles and bar handles can only be mounted vertically.

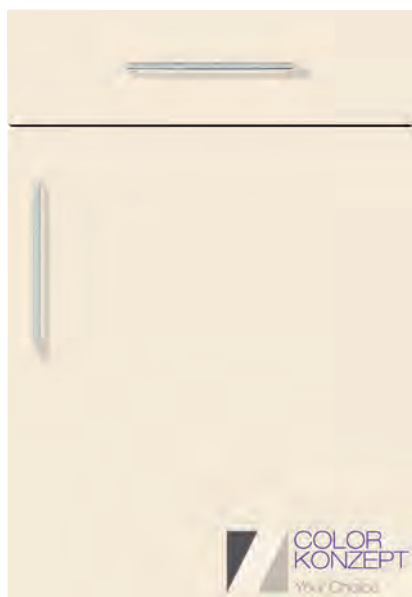

No. 391 Substrate smooth



Available front colours



CK311 white

CK312 magnolia white

CK331 Thyme



CK314 Pebble grey

CK330 Cappuccino

CK329 Volcano brown

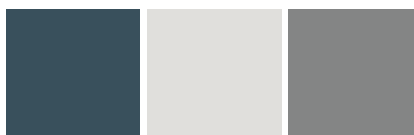

CK328 Alby Blue

CK327 Space grey

CK326 Slate grey



CK315 graphite

CK321 black

Information on the range

Door: Support panel with all-round small radius. Moulded frame. Surface matt lacquered.

Door thickness: 19 mm

Information concerning the door:

Handle assembly on wooden doors:

Standard: vertical

Optional: horizontal centred

Cannot be combined with handle no. 783.

The express delivery services are not available for this range.

Glass types

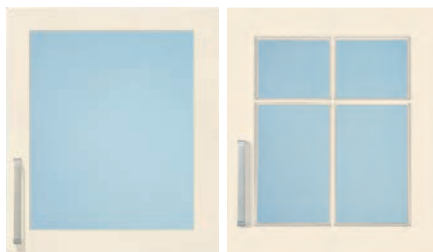

Framed glass door in front colour No. 701 Note the available glass choices. Glass door with glazing bars in front colour No. 705 Note the available glass choices.



No. 397 Carrier country house modern

NEW



Available front colours

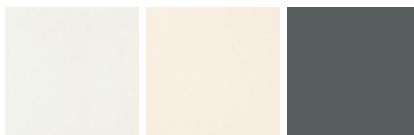

CK311 white
CK312 magnolia white
CK331 Thyme



CK314 Pebble grey
CK330 Cappuccino
CK329 Volcano brown

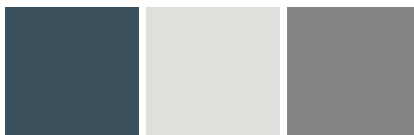

CK328 Alby Blue
CK327 Space grey
CK326 Slate grey



CK315 graphite
CK321 black

Information on the range

Door: Support panel moulded.
Surface matt lacquered.

Door thickness: 19 mm

Information concerning the door:
Handle assembly on wooden doors:
Standard: vertical
Optional: horizontal centred
Centre-positioned handle 783 is not possible.

The express delivery services are not available for this range.

Glass types

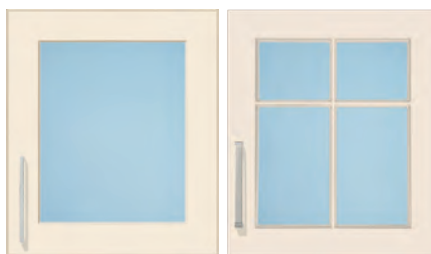

Framed glass door in front colour No. 701
Note the available glass choices. Glass door with glazing bars in front colour No. 705
Note the available glass choices.



No. 394 Carrier country house classico



Available front colours



CK311 white
CK312 magnolia white
CK331 Thyme



CK314 Pebble grey
CK330 Cappuccino
CK329 Volcano brown

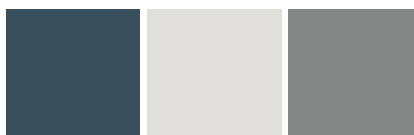

CK328 Alby Blue
CK327 Space grey
CK326 Slate grey



CK315 graphite
CK321 black

Notes

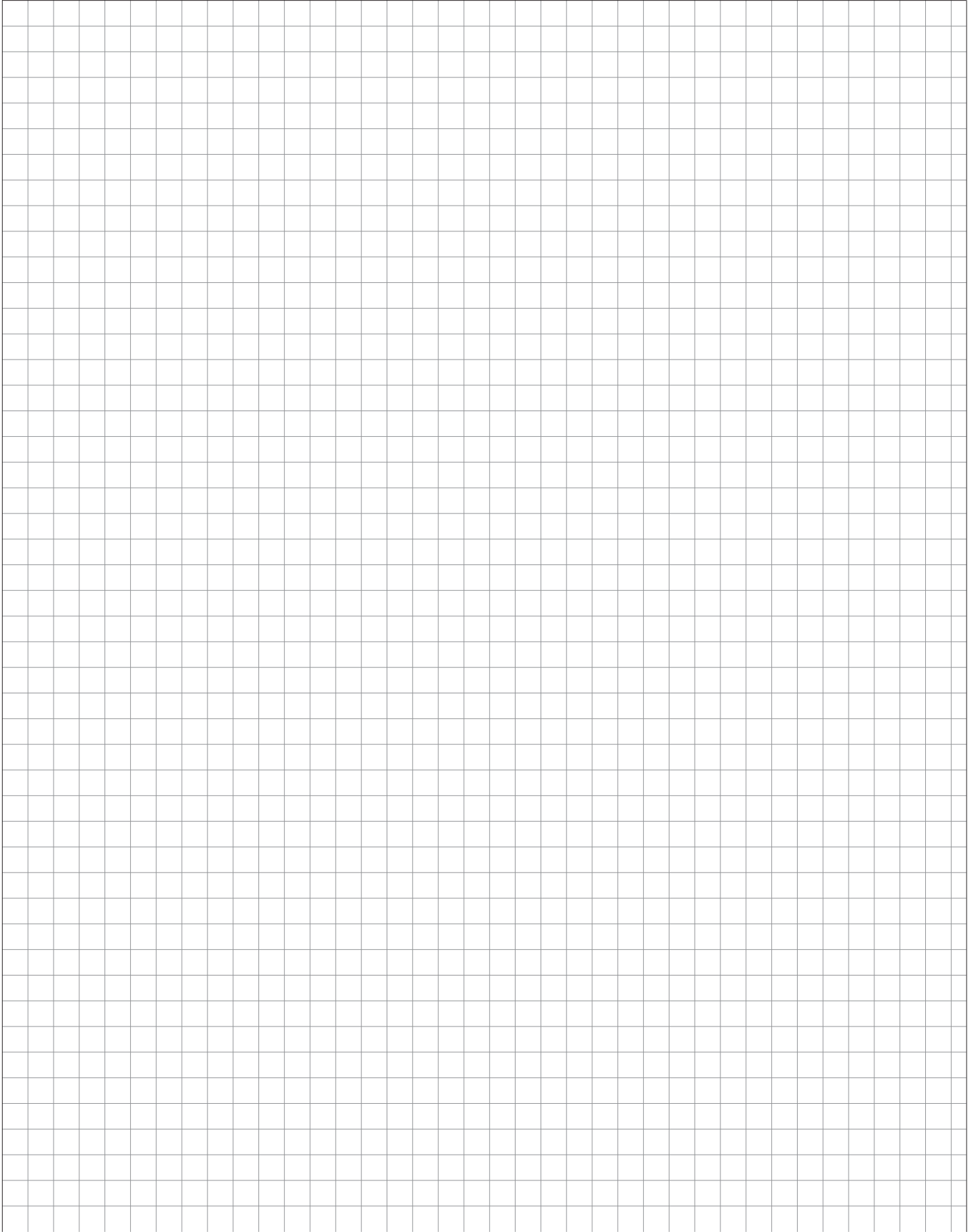

Design colours, handles

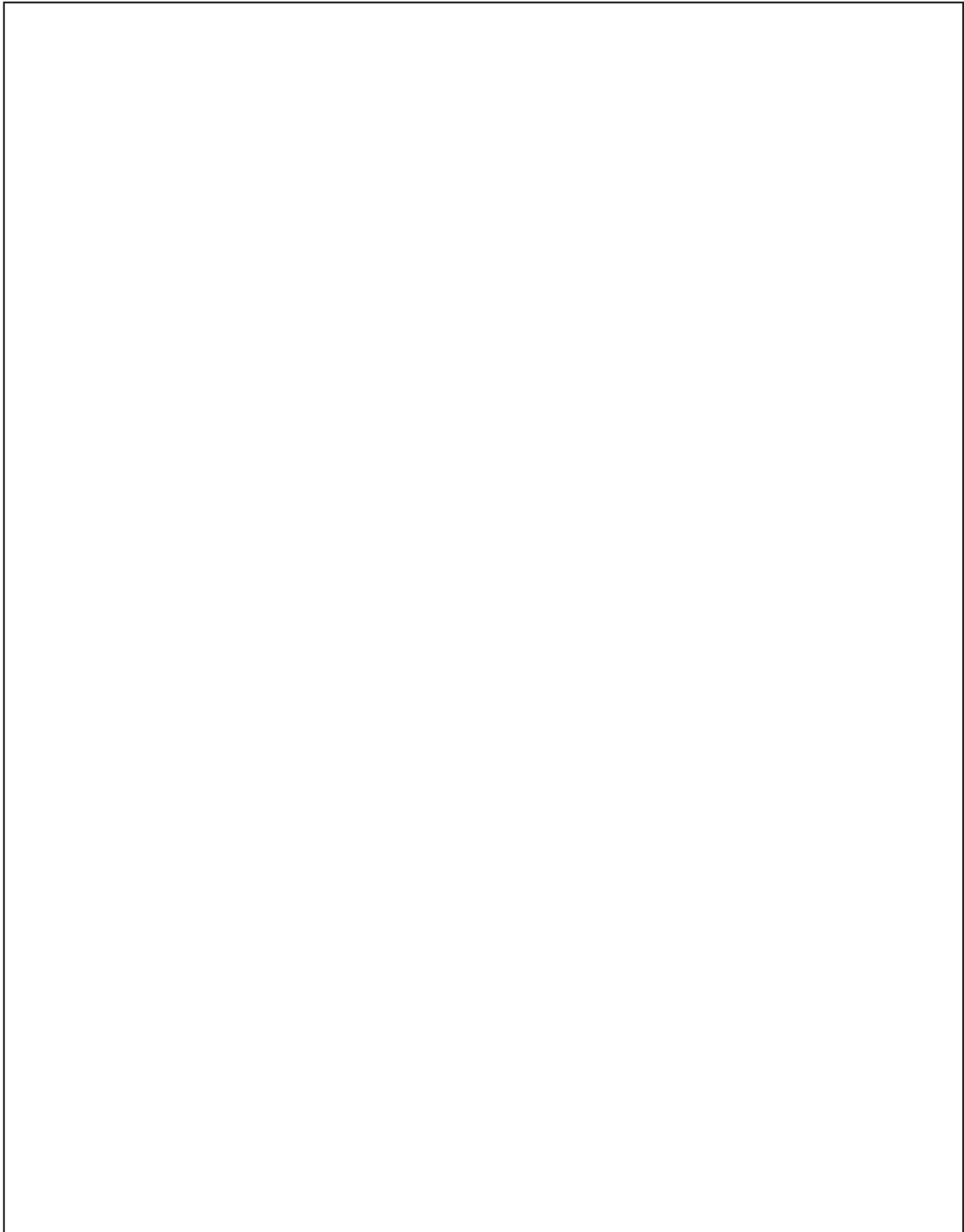

Design colours, handles



Glass types

Overview

Available glass types for:

- Framed glass door No. 701
- Framed glass door No. 704
- Segmented glass door No. 706
- Glass door with glazing bars No. 705



No. 802
Frosted glass



No. 803
Clear glass



No. 815
Smoke glass

Glass types for:

Framed glass door type -N1



No. 816
glass white



No. 808
glass black

Universal glass doors



Glass door no. 49 with white glass
no. 816
Type N1



Glass door no. 48 with black glass
no. 808
Type N1

Carcase colours

Carcase interior colour is always white, variations according to unit description.

Laminate



No. 111
Light oak effect



No. 160
Summerfield oak effect

NEW



No. 780
vintage oak effect

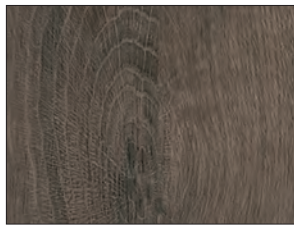

No. 890
Oregon oak effect

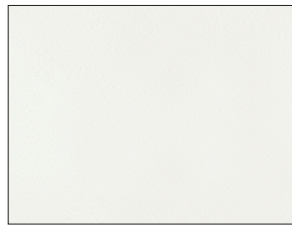

No. 517
white

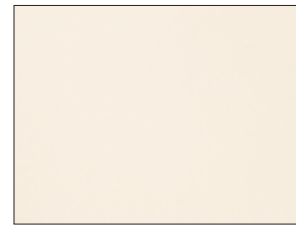

No. 750
magnolia white

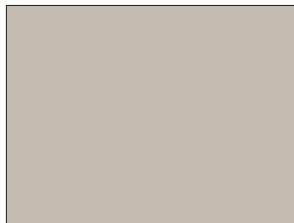

No. 840
Pebble grey

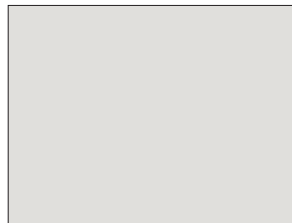

No. 900
Space grey

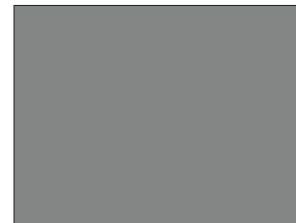

No. 132
Slate grey



No. 830
graphite







No. 120
black



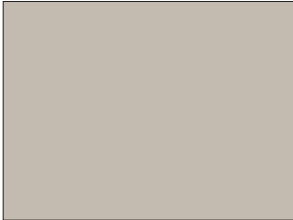
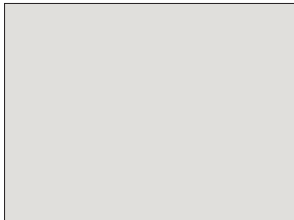
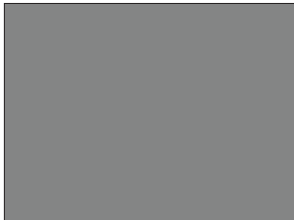

Colours of visible sides

Carcase interior colour is always white, variations according to unit description.

Matt

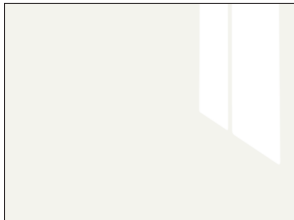
		
No. 167 white	No. 168 magnolia white	No. 169 Pebble grey
		
No. 172 Space grey	No. 144 Slate grey	No. 157 graphite
		
No. 156 black		

High-gloss

		
No. 791 high-gloss white	No. 792 high-gloss magnolia white	No. 937 high-gloss pebble grey
		
No. 115 high-gloss space grey	No. 939 high-gloss graphite	

Plinth colours



No. 111
Light oak effect
Substrate wood material



No. 160
Summerfield oak effect



No. 780
vintage oak effect
Substrate wood material



No. 890
Oregon oak effect
Substrate wood material

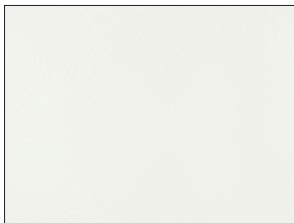

No. 517
white
Substrate wood material

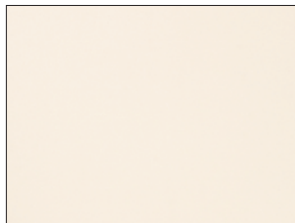

No. 750
magnolia white
Substrate wood material

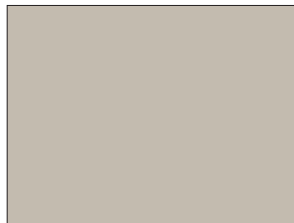

No. 840
Pebble grey
Substrate wood material

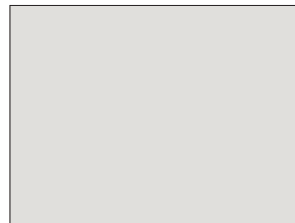

No. 900
Space grey
Substrate wood material

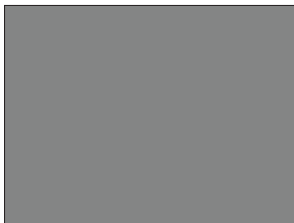

No. 132
Slate grey

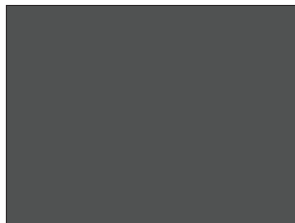

No. 830
graphite
Substrate wood material



No. 120
black
Substrate wood material

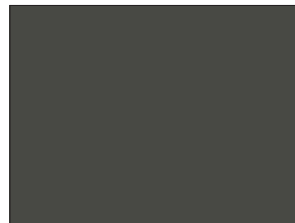

No. 133
Volcano brown

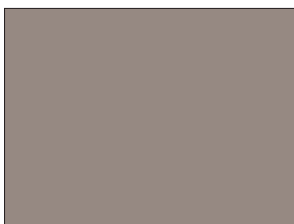

No. 112
Cappuccino

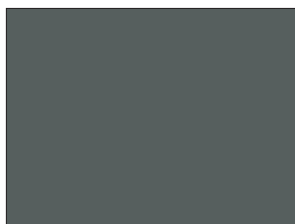

No. 121
Thyme

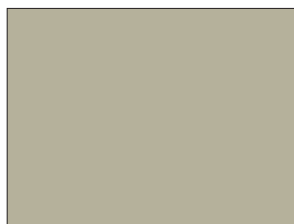

No. 158
Sage green



No. 945
Concrete look in light slate grey
Substrate wood material

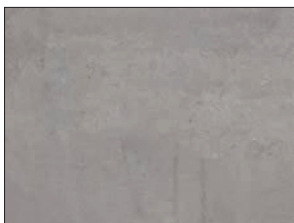

No. 923
Concrete effect, natural
Substrate wood material

Plinth colours

Extra charge



No. 152
white gloss
Surcharge group 1



No. 299
Stainless steel effect
Plastic hollow section
Surcharge group 2

Glass niche back panel

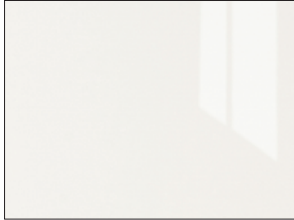

No. 434
white



No. 435
magnolia white



No. 439
Space grey



No. 456
graphite



No. 436
black

Niche back panel motifs

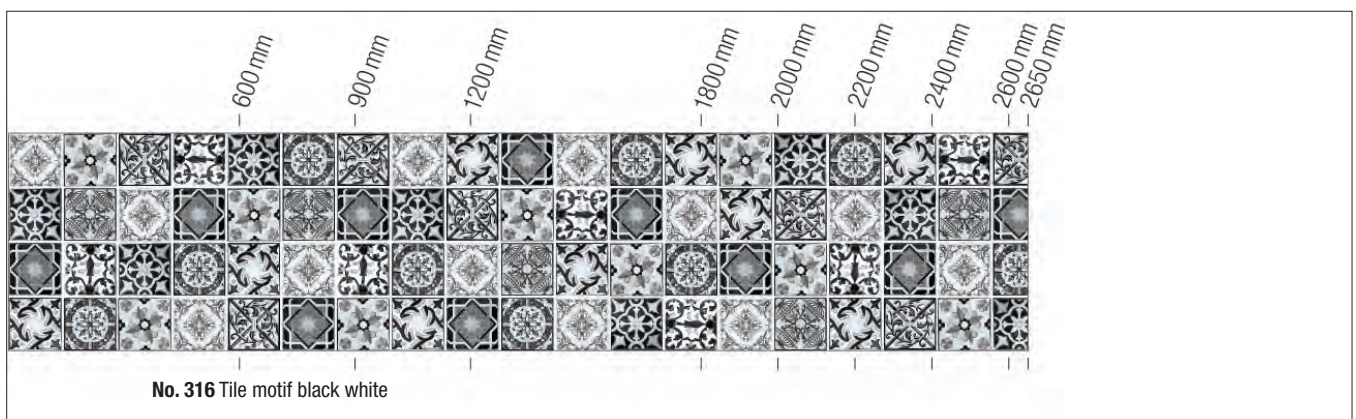
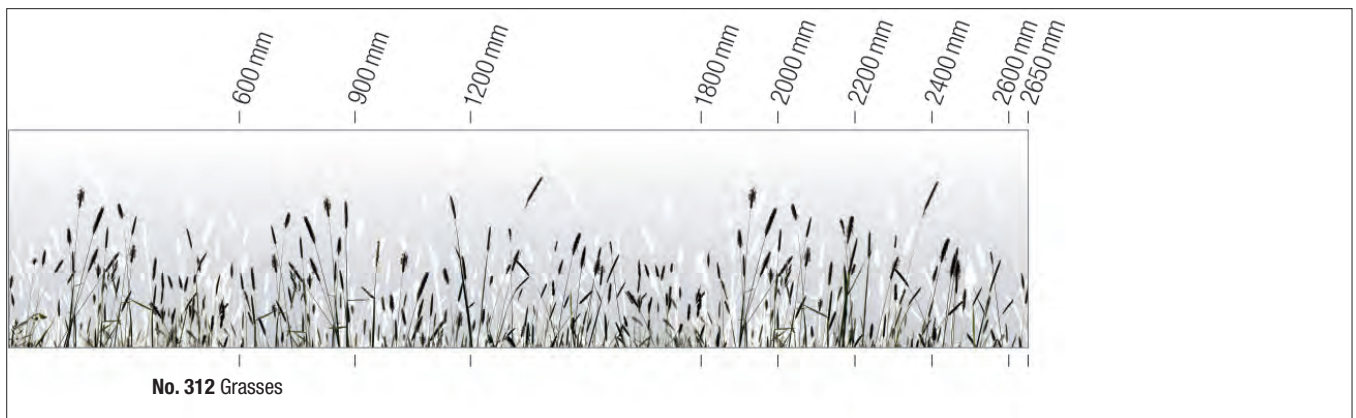
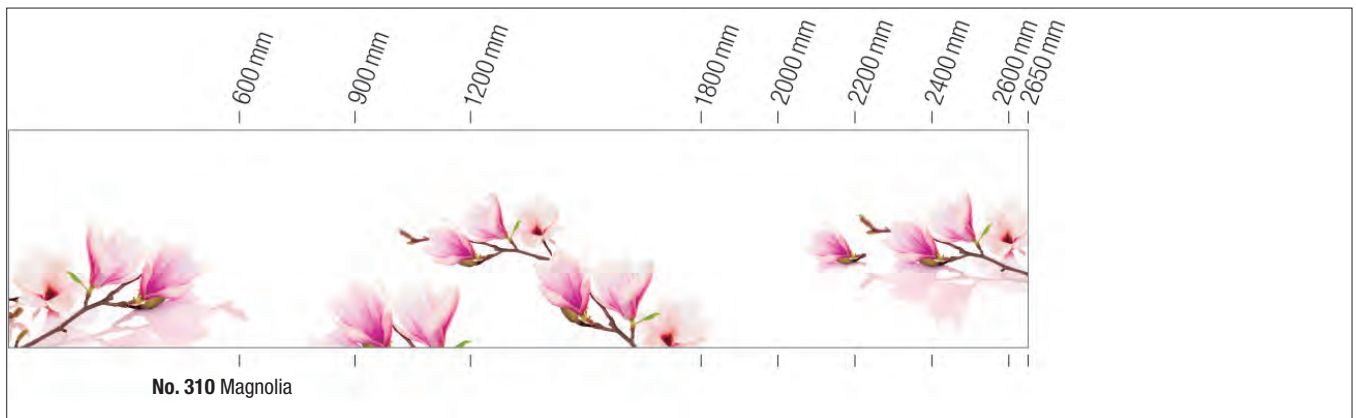
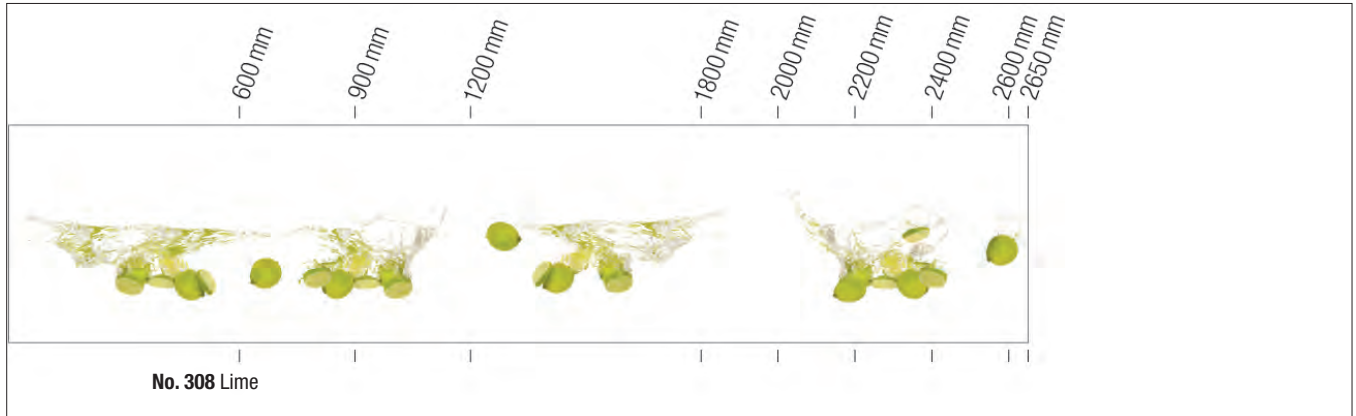

Niche back panel motifs

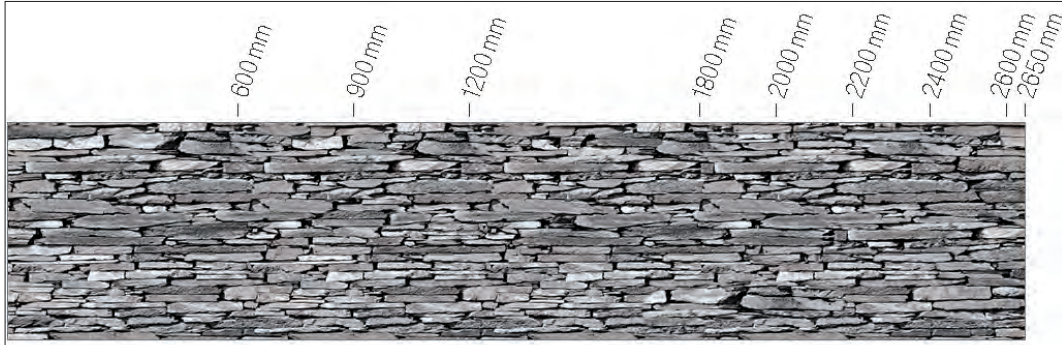

No. 320 Slate wall

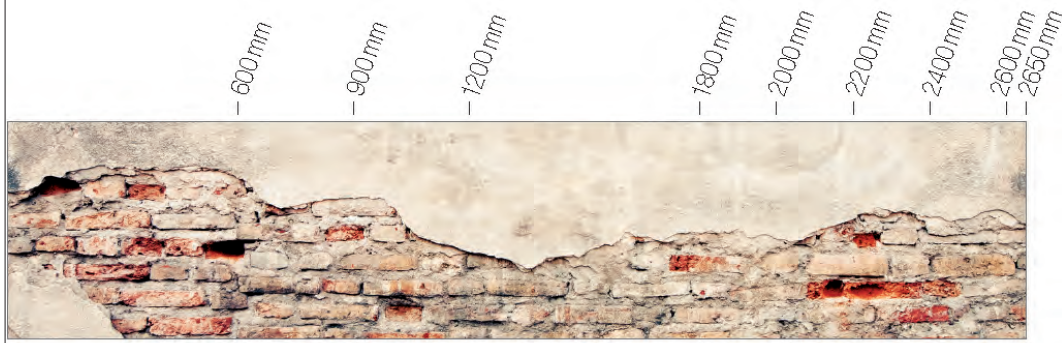

No. 322 Brickwork

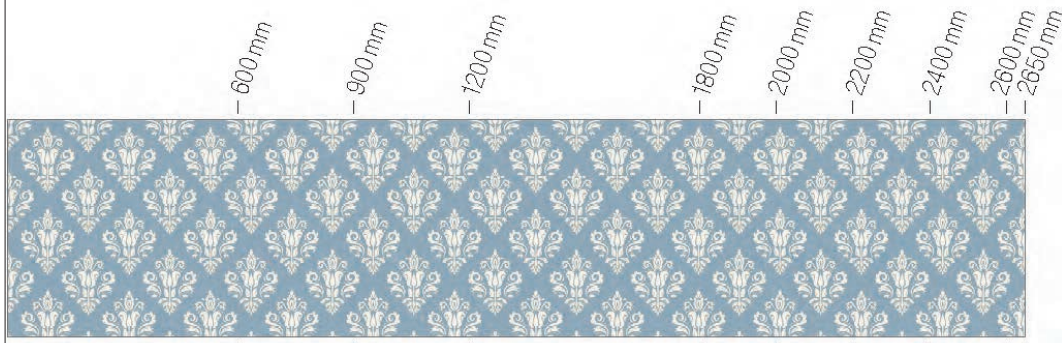

No. 327 Ornamental

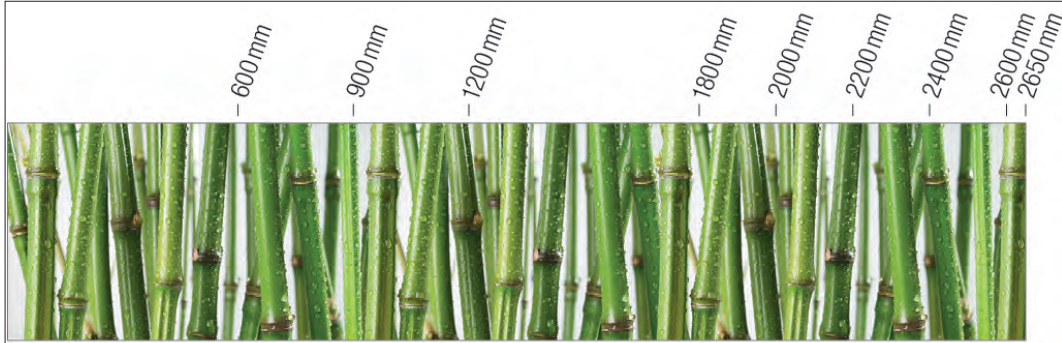

No. 329 Bamboo

Niche back panel motifs

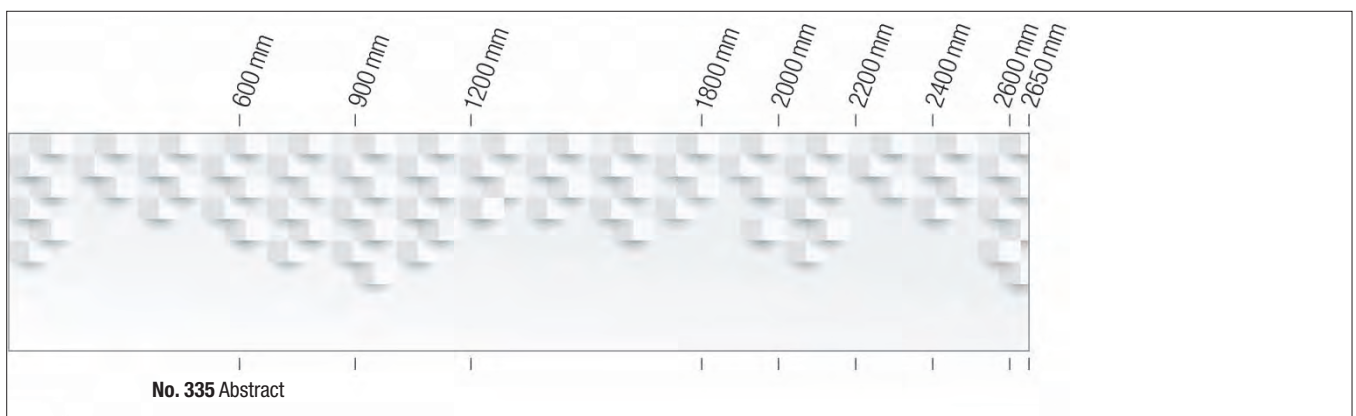
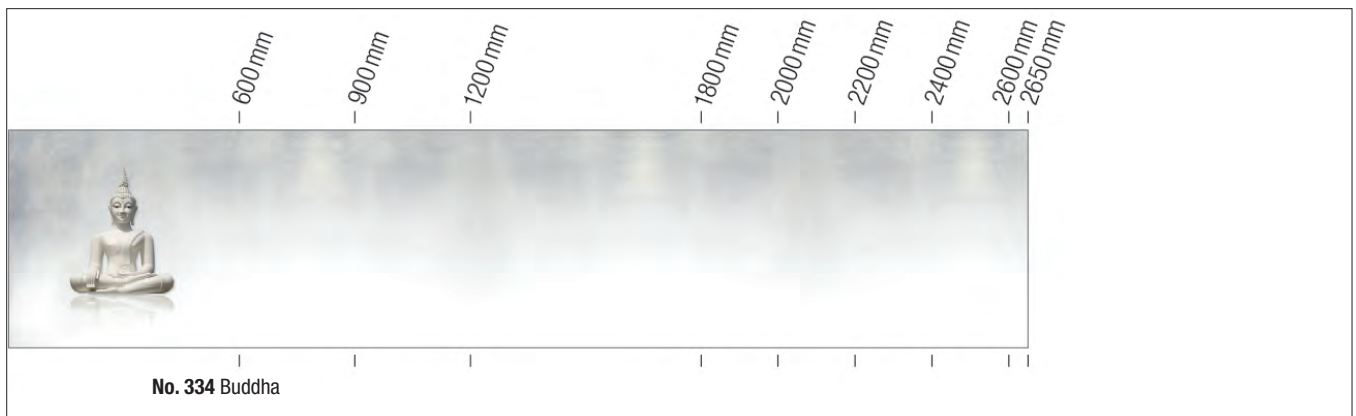
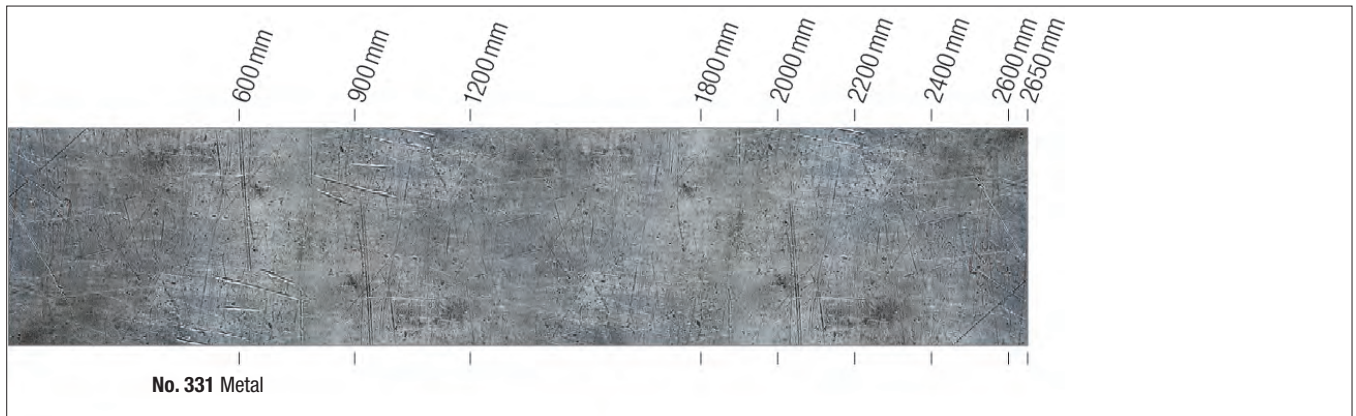
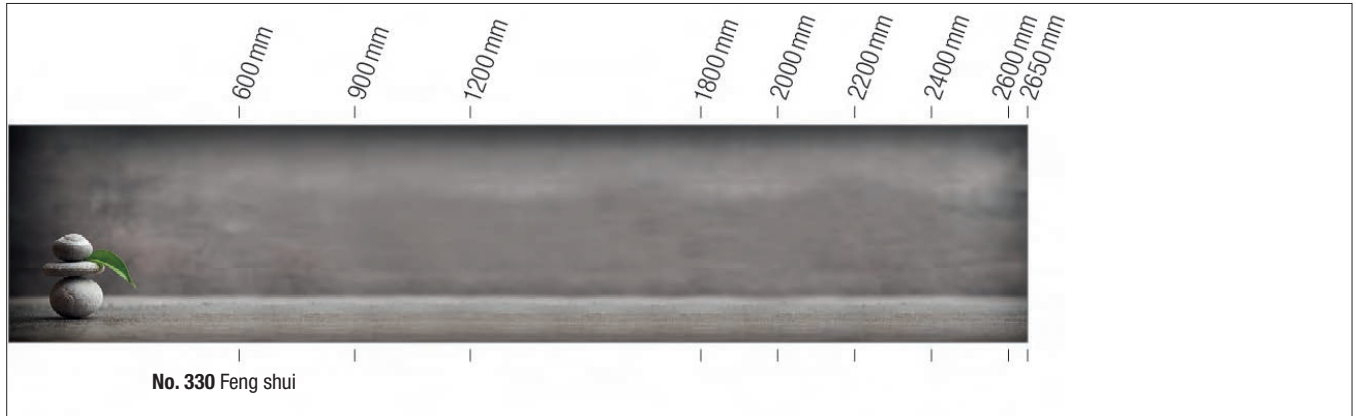

Niche back panel motifs

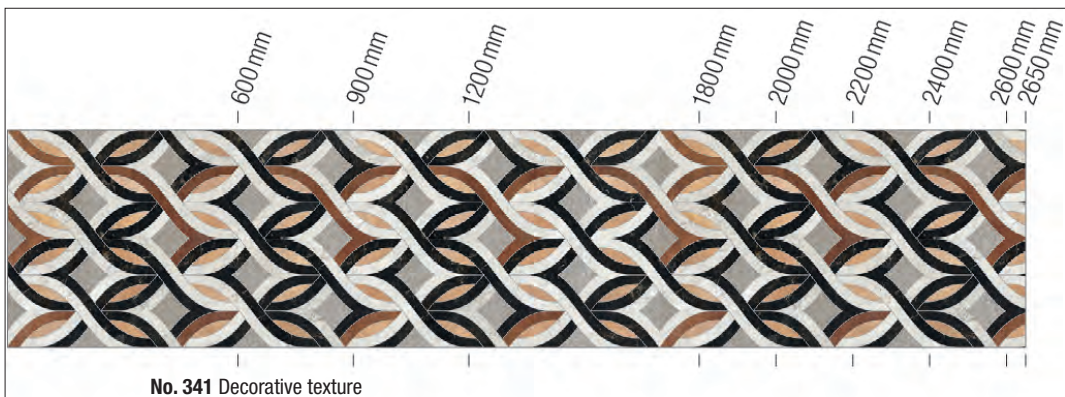
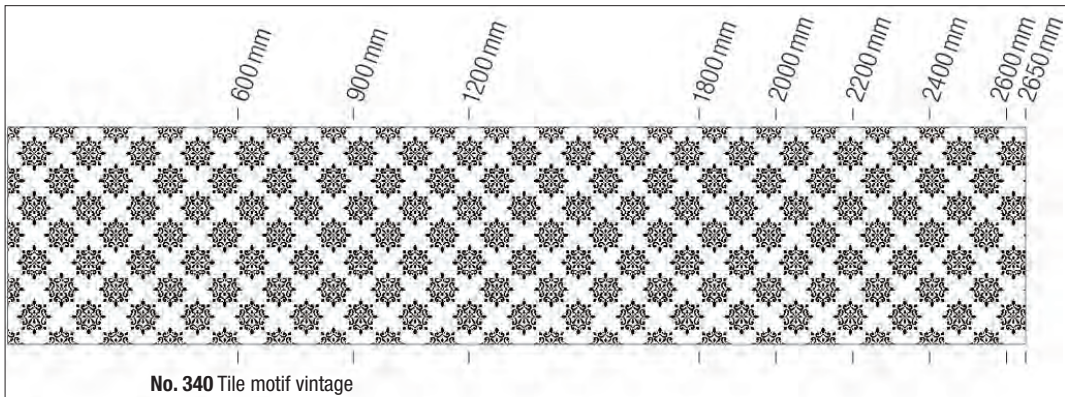
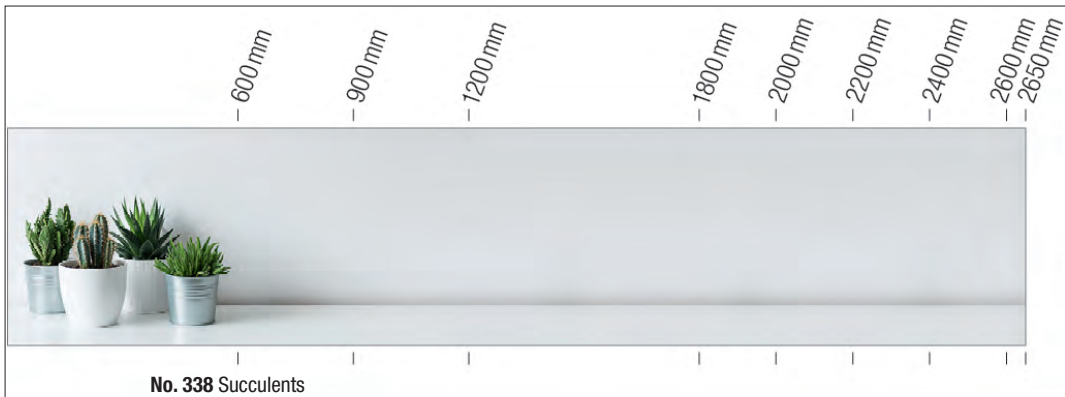



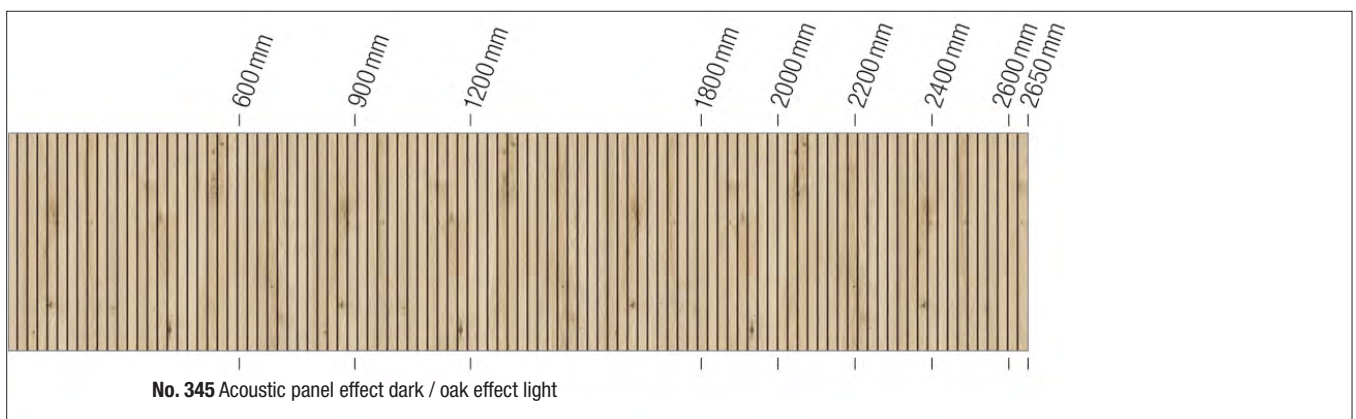
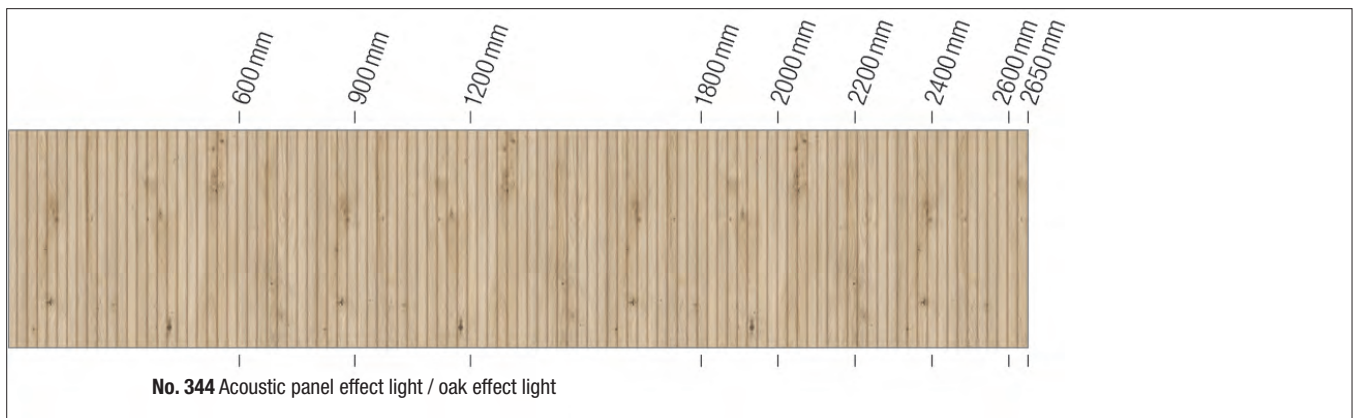
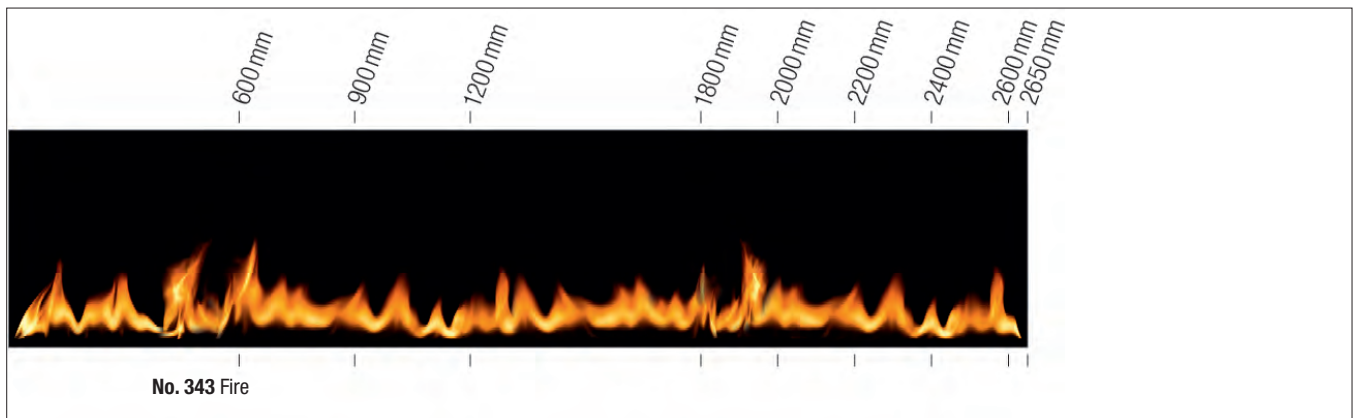







Niche back panel motifs

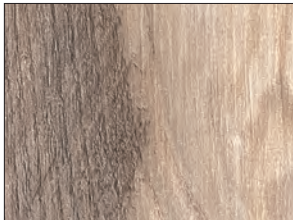
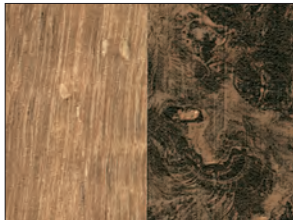

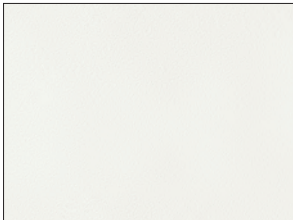
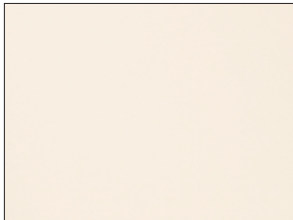
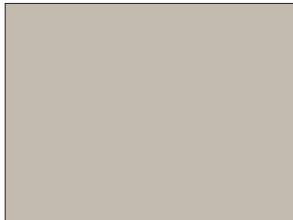
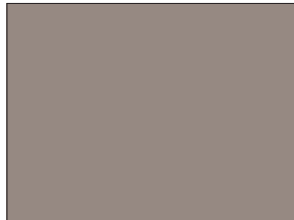

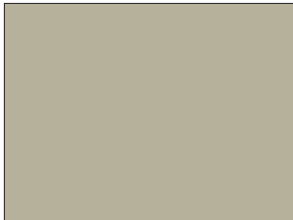
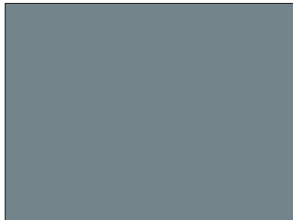
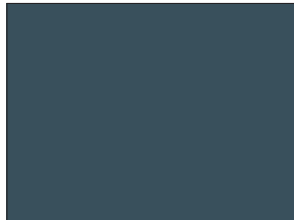
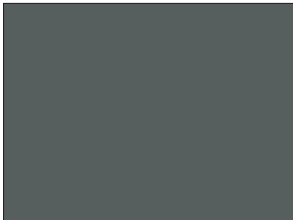
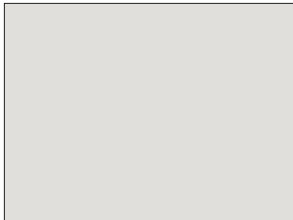
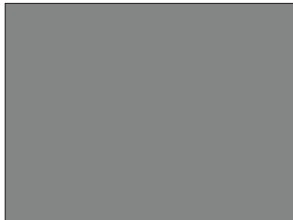



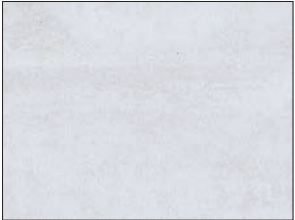

Panel colours 16 mm, 25 mm

Overview

			
<p>No. 111 16mm 25mm Light oak effect Item types matt</p>	<p>No. 160 16mm 25mm NEW Summerfield oak effect Item types matt</p>	<p>No. 850 16mm 25mm Havana oak effect Item types matt</p>	<p>No. 780 16mm 25mm vintage oak effect Item types matt</p>
			
<p>No. 890 16mm 25mm Oregon oak effect Item types matt</p>	<p>No. 128 16mm Wild West Item types matt</p>	<p>No. 117 16mm Hunton oak effect Item types matt</p>	<p>No. 114 16mm Oak effect black Item types matt</p>
			
<p>No. 517 16mm 25mm white Item types matt</p>	<p>No. 750 16mm 25mm magnolia white Item types matt</p>	<p>No. 840 16mm 25mm Pebble grey Item types matt</p>	<p>No. 112 16mm Cappuccino Item types matt</p>
			
<p>No. 133 16mm Volcano brown Item types matt</p>	<p>No. 158 16mm NEW Sage green Item types matt</p>	<p>No. 952 16mm Petrol Item types matt</p>	<p>No. 134 16mm Alby Blue Item types matt</p>
			
<p>No. 121 16mm Thyme Item types matt</p>	<p>No. 900 16mm 25mm Space grey Item types matt</p>	<p>No. 132 16mm 25mm Slate grey Item types matt</p>	<p>No. 830 16mm 25mm graphite Item types matt</p>

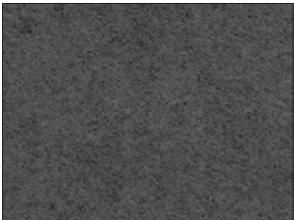

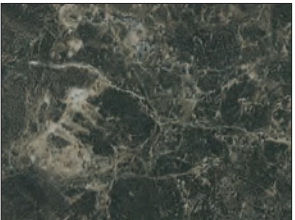
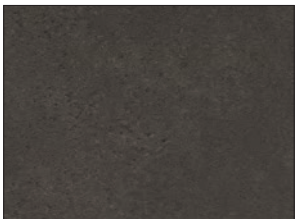
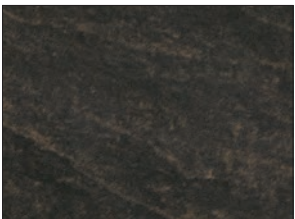
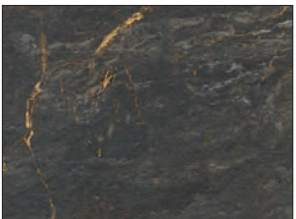

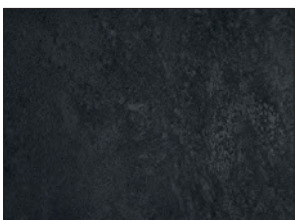
Panel colours 16 mm, 25 mm

Overview

 <p>No. 120 black Item types matt</p> <p>16 mm 25 mm</p>	 <p>No. 683 Concrete effect, slate light grey Item types matt</p> <p>16 mm 25 mm</p>	 <p>No. 674 Concrete effect, natural Item types matt</p> <p>16 mm 25 mm</p>	 <p>No. 684 Concrete effect, slate dark grey Item types matt</p> <p>16 mm 25 mm</p>
 <p>No. 148 Jupiter sand Item types matt</p> <p>16 mm 25 mm</p>	 <p>No. 648 Lava grey, stone structure Item types matt</p> <p>16 mm 25 mm</p>	 <p>No. 151 Marble white Item types matt</p> <p>16 mm 25 mm</p>	 <p>No. 147 Marble green Item types matt</p> <p>16 mm 25 mm</p>
 <p>No. 166 Terra grey Item types matt</p> <p>16 mm 25 mm NEW</p>	 <p>No. 149 Slate texture copper Item types matt</p> <p>16 mm 25 mm</p>	 <p>No. 165 Titian Item types matt</p> <p>16 mm 25 mm NEW</p>	 <p>No. 685 Carrara black Item types matt</p> <p>16 mm</p>
 <p>No. 146 Slate texture black Item types matt</p> <p>16 mm 25 mm</p>			

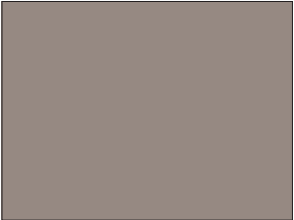
Panel colours 16 mm, 25 mm

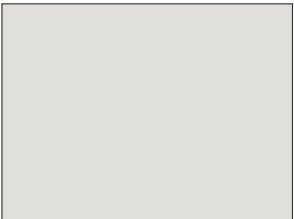
Overview

			
No. 167 white Lacquer (matt lacquer on one side) Item types matt lacquer	No. 168 magnolia white Lacquer (matt lacquer on one side) Item types matt lacquer	No. 169 Pebble grey Lacquer (matt lacquer on one side) Item types matt lacquer	No. 171 Cappuccino Lacquer (matt lacquer on one side) Item types matt
			
No. 144 Slate grey Lacquer (matt lacquer on one side) Item types matt lacquer	No. 164 Sage green Lacquer (matt lacquer on one side)	No. 145 Volcano brown Lacquer (matt lacquer on one side) Item types matt lacquer	No. 172 Space grey Lacquer (matt lacquer on one side) Item types matt lacquer
			
No. 157 graphite Lacquer (matt lacquer on one side) Item types matt lacquer	No. 156 black Lacquer (matt lacquer on one side) Item types matt lacquer		

Panel colours 16 mm, 25 mm

Overview

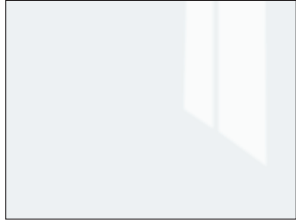

No. 791 16mm
high-gloss white
Lacquer
(high-gloss lacquer on one side)
Item types high-gloss

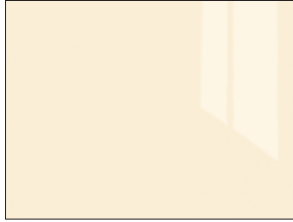

No. 792 16mm
high-gloss magnolia white
Lacquer
(high-gloss lacquer on one side)
Item types high-gloss



No. 937 16mm
high-gloss pebble grey
Lacquer
(high-gloss lacquer on one side)
Item types high-gloss



No. 924 16mm
high-gloss red
Lacquer
(high-gloss lacquer on one side)
Item types high-gloss



No. 115 16mm
high-gloss space grey
Lacquer
(high-gloss lacquer on one side)
Item types high-gloss



No. 939 16mm
high-gloss graphite
Lacquer
(high-gloss lacquer on one side)
Item types high-gloss

Worktop decor finishes 25 mm, 40 mm

Overview

Note that the finishes are offset and not continuous where worktops and edges join together.

The illustrations show only a section of the overall finish. For technical reasons, colours and structures may differ from the originals.



Edging PLR

Worktop 40 mm thick, with rounded front edge, both front edges with edging in same colour as worktop surface.

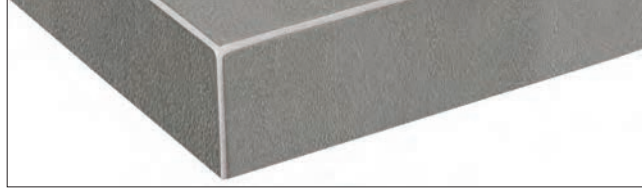

Edging PLS

Panel approx. 25 / 40 mm thick, with a straight front edge, both leading edges with edging strip in the same colour as the worktop surface.



No. 111
Light oak effect

25 mm 40 mm



No. 160
Summerfield oak effect
Only available in PLS finish.

25 mm 40 mm **NEW**

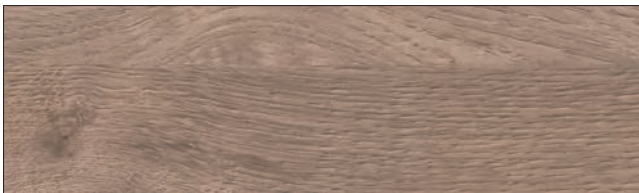

No. 673
Havana oak effect

40 mm



No. 653
vintage oak effect

40 mm

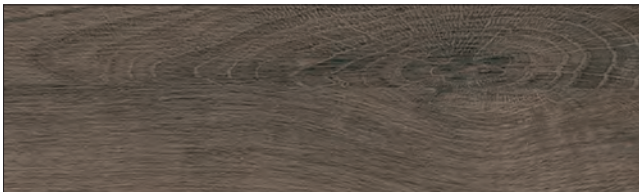

No. 688
Oregon oak effect

40 mm



No. 128
Wild West
Large-scale finish with marked differences in colour.

40 mm



No. 117
Hunton oak effect
Large-scale finish with marked differences in colour.

40 mm

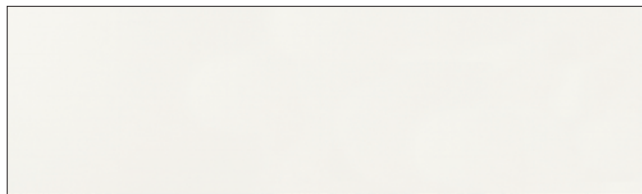

No. 619
white

25 mm 40 mm



No. 683
Concrete effect, slate light grey

25 mm 40 mm

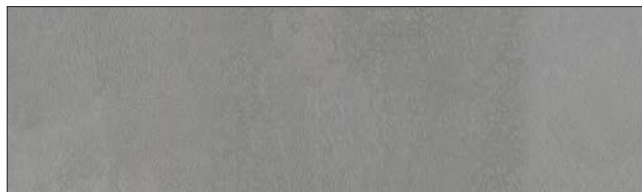

No. 674
Concrete effect, natural

40 mm

Worktop decor finishes 25 mm, 40 mm

Overview

Note that the finishes are offset and not continuous where worktops and edges join together.

The illustrations show only a section of the overall finish. For technical reasons, colours and structures may differ from the originals.



No. 684
Concrete effect, slate dark grey

25 mm 40 mm



No. 148
Jupiter sand
Only available in PLS finish.

25 mm 40 mm

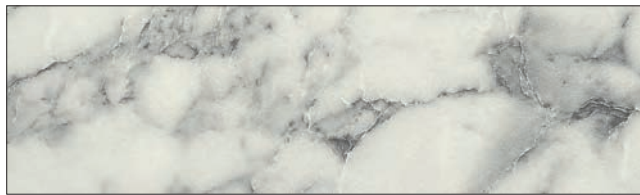

No. 151
Marble white
Only available in PLS finish.

25 mm 40 mm

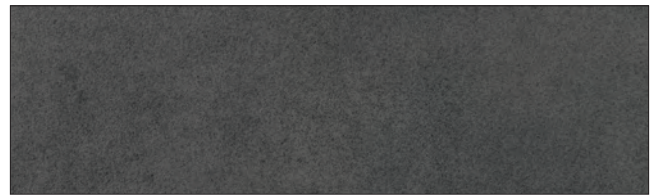

No. 648
Lava grey, stone structure

25 mm 40 mm

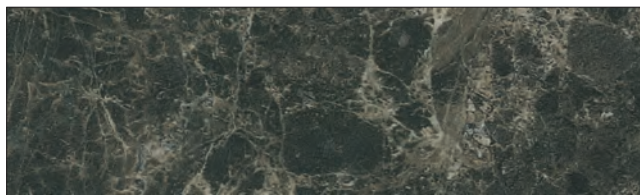

No. 147
Marble green
Large-scale finish with marked differences in colour.
Only available in PLS finish.

25 mm 40 mm

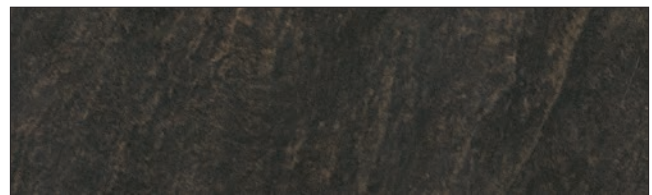

No. 149
Slate texture copper
Only available in PLS finish.

25 mm 40 mm

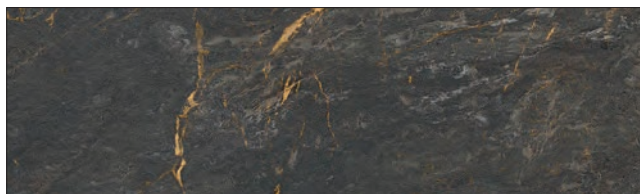

No. 165
Titian
Only available in PLS finish. Large-scale finish with marked differences in colour.

25 mm 40 mm NEW



No. 685
Carrara black
Large-scale finish with marked differences in colour.

40 mm

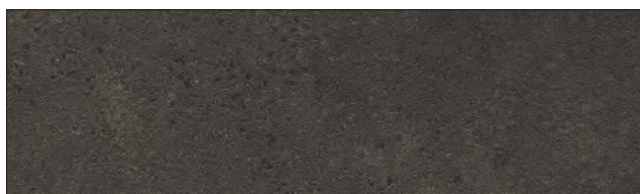

No. 166
Terra grey
Only available in PLS finish.

25 mm 40 mm NEW

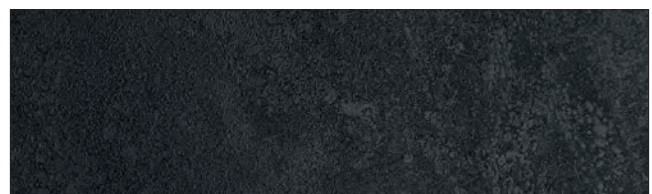







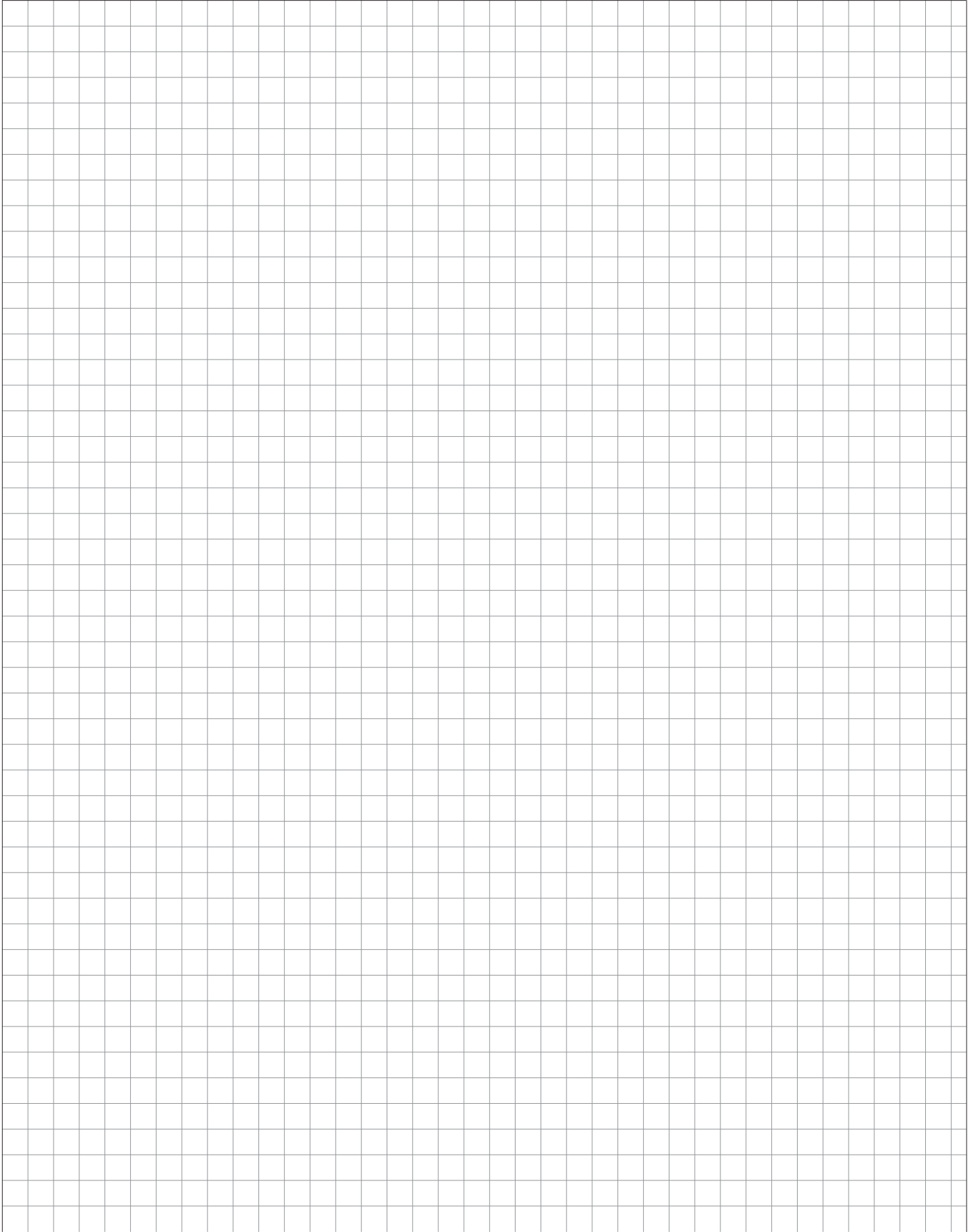









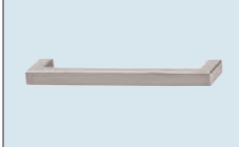



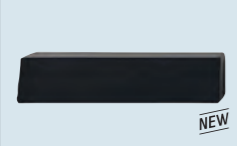



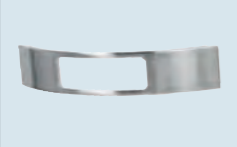



No. 146
Slate texture black
Only available in PLS finish.

25 mm 40 mm

Notes









Summary of handles

				
No. 715 Metal knob stainless steel-effect Projection to the front: 40 mm	No. 775 Metal knob Black Projection to the front: 27 mm	No. 776 Metal knob Gold effect Projection to the front: 27 mm	No. 629 Metal D-handle stainless steel-effect drilling distance: 128 mm Projection to the front: 33 mm	No. 690 Metal D-handle stainless steel-effect drilling distance: 128 mm Projection to the front: 35 mm
				
No. 695 Metal D-handle stainless steel-effect drilling distance: 128 mm Projection to the front: 30 mm	No. 702 Metal D-handle stainless steel-effect drilling distance: 128 mm Projection to the front: 41 mm	No. 742 Metal D-handle Antique silver-effect drilling distance: 128 mm Projection to the front: 38 mm	No. 754 Metal D-handle Black drilling distance: 128 mm Projection to the front: 40 mm	No. 771 Metal D-handle Black drilling distance: 128 mm Projection to the front: 33 mm
				
No. 783 Shell handle Black drilling distance: 128 mm Projection to the front: 20 mm	No. 646 Metal D-handle stainless steel-effect drilling distance: 160 mm Projection to the front: 29 mm	No. 705 Metal D-handle stainless steel-effect drilling distance: 160 mm Projection to the front: 41 mm	No. 706 Metal D-handle stainless steel-effect drilling distance: 160 mm Projection to the front: 32 mm	No. 712 Metal D-handle stainless steel-effect drilling distance: 160 mm Projection to the front: 30 mm
				
No. 716 Metal D-handle stainless steel-effect drilling distance: 160 mm Projection to the front: 34 mm	No. 721 D-handle black chrome-effect drilling distance: 160 mm Projection to the front: 28 mm	No. 722 Metal D-handle burnished, brushed drilling distance: 160 mm Projection to the front: 22 mm	No. 723 Metal D-handle stainless steel-effect drilling distance: 160 mm Projection to the front: 35 mm	No. 727 Metal D-handle black chrome-effect drilling distance: 160 mm Projection to the front: 25 mm
				
No. 749 Metal D-handle Stainless steel look / black drilling distance: 160 mm Projection to the front: 36 mm	No. 757 Metal D-handle Antique iron effect drilling distance: 160 mm Projection to the front: 28 mm	No. 759 Metal D-handle stainless steel-effect drilling distance: 160 mm Projection to the front: 26 mm	No. 761 Metal D-handle Copper effect drilling distance: 160 mm Projection to the front: 29 mm	No. 762 Metal D-handle Black drilling distance: 160 mm Projection to the front: 28 mm
				
No. 763 Metal D-handle Anthracite drilling distance: 160 mm Projection to the front: 28 mm	No. 772 Metal D-handle Gold effect drilling distance: 160 mm Projection to the front: 27 mm	No. 778 Metal D-handle Black drilling distance: 160 mm Projection to the front: 28 mm	No. 779 Metal D-handle Black drilling distance: 160 mm Projection to the front: 34 mm	No. 781 Metal D-handle Black drilling distance: 160 mm Projection to the front: 30 mm

* = surcharge handle, ** = surcharge bar handle / grip ledge

Summary of handles

				
No. 782 Metal D-handle Black drilling distance: 160 mm Projection to the front: 30 mm	No. 784 Metal D-handle Black drilling distance: 160 mm Projection to the front: 35 mm	No. 785 Metal D-handle Black drilling distance: 160 mm Projection to the front: 26 mm	No. 786 Metal D-handle Black drilling distance: 160 mm Projection to the front: 30 mm	No. 672 Metal D-handle stainless steel-effect drilling distance: 192 mm Projection to the front: 24 mm
				
No. 684 Metal D-handle stainless steel-effect drilling distance: 192 mm Projection to the front: 32 mm				

* = surcharge handle, ** = surcharge bar handle / grip ledge

Summary of handles

Handles at an extra charge



No. 680
Bar handle stainless steel-effect
Projection to the front: 33 mm

**



No. 820
Bar handle Black
Projection to the front: 33 mm

**



No. 700
Bar handle stainless steel-effect
Projection to the front: 39 mm

**

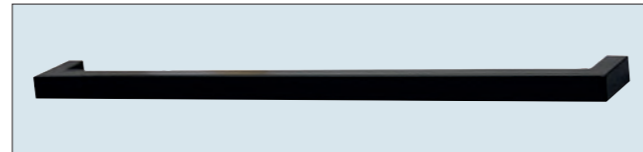

No. 810
Bar handle Black
Projection to the front: 39 mm

**

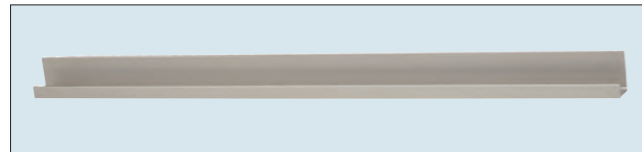

No. 760
Strip handle stainless steel-effect
Only possible from a front thickness of 19 mm!

**



No. 800
Strip handle Black
Only possible from a front thickness of 19 mm!

**

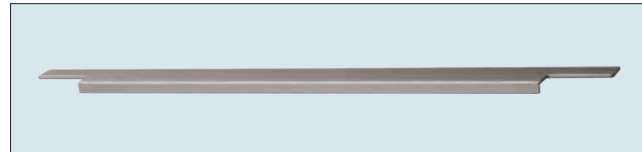

No. 740
Strip handle stainless steel-effect
Projection to the front: 21 mm
Possible for 16 / 19 mm fronts!

**

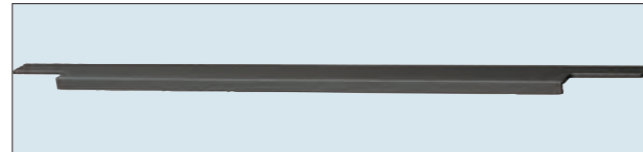

No. 780
Strip handle Anthracite
Projection to the front: 21 mm
Possible for 16 / 19 mm fronts!

**

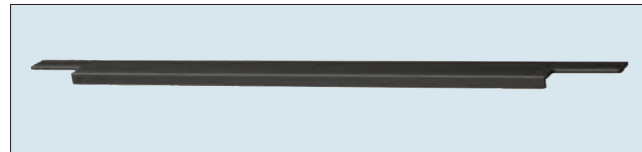

No. 790
Strip handle Black
Projection to the front: 21 mm
Possible for 16 / 19 mm fronts!

**

Summary of handles

Handles at an extra charge



No. 960
Range C Recessed handle stainless steel-effect



No. 980
Range C Recessed handle white



No. 970
Range C Recessed handle Black



No. 990
Range C Recessed handle Copper effect

2. Base units

Legend of symbols used
Summary of the most used/planned base units
Base units
Hob housings / sink base units
MAXI base units 867 mm
Base unit interior equipment / waste systems

Legend of symbols used



Width reduction

For surcharges and information see register 9 Design elements, special topics, sub-register Surcharges/miscellaneous

Units shortened to the next smallest unit width available.
Example: unit width 600 mm = shortened to 501 mm

Reduction only available for reducible ranges with edging finish.
Possible ranges:
IP 1200, IP 2200, IP 3150, IP 4050

Width reduction of D-handles and knobs is possible.

Handle designs depending on length (bar handles, grip ledges) are not possible where width is shortened.



Depth reduction

For surcharges and information see register 9 Design elements, special topics, sub-register Surcharges/miscellaneous



Width and depth reduction

Combination of both variants

For surcharges and information see register 9 Design elements, special topics, sub-register Surcharges/miscellaneous



Base unit with carcass depth 326 mm

Plinth feet are supplied loose.
For units with drawer / deep drawer:
- drawer / deep drawer depth 270 mm
- units always with Servosoft



Base unit with carcass depth 460 mm

For units with drawer / deep drawer:
- drawer / deep drawer depth 400 mm
- units always with Servosoft

Information on customised products

Please note the possible customisations for cabinets.

The following individualisations are possible:

- Width reduction
- Depth reduction
- Carcase with increased side depth

You will find further information on this under register 9 Design elements, special topics, sub-register Surcharges/miscellaneous.

Equipment versions

	<p>Drawers / deep drawers in standard finish TANDEMBOX plus</p> <p>Colour silver grey Version: 506 = full-extension pull-out with Servosoft (allow for surcharge!)</p>
	<p>Drawers / deep drawers Professional (surcharge) TANDEMBOX antaro</p> <p>Colour anthracite Full-extension pull-out with Servosoft Version: 508 = Professional full-extension pull-out with Servosoft</p>
	<p>Drawers / deep drawers Professional with glass side (surcharge) TANDEMBOX antaro</p> <p>Colour anthracite Full-extension pull-out with Servosoft Versions: 510 = Professional with Servosoft and clear glass 512 = Professional with Servosoft and frosted glass</p>
	<p>Non-slip mats (surcharge per unit)</p> <p>All drawers / deep drawers in a batch are fitted with the available non-slip mats</p> <p>Drawer / deep drawer features: Versions: 99 = Without non-slip mat 106 = Non-slip mat in silver-grey 108 = Non-slip mat in anthracite</p>
	<p>Clip hinge, standard version</p> <p>Version 414</p> <p>in combination with a high-quality flap stay</p>
	<p>Cushioning for hinged doors Top Motion (surcharge)</p> <p>Version 418</p> <p>Integrated door cushioning CLIP top BLUMOTION by Blum in combination with a high-quality flap stay</p>
	<p>Cushioning for hinged doors Top Motion (surcharge)</p> <p>Version 428</p> <p>Integrated door cushioning CLIP top BLUMOTION by Blum in combination with AVENTOS HKS flap stay by Blum</p>

Summary of the most used/planned base units

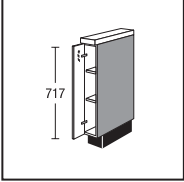
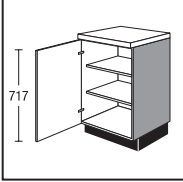
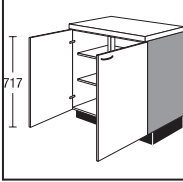
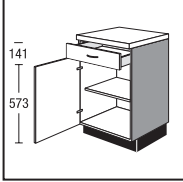
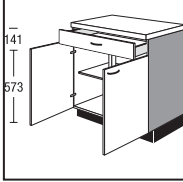
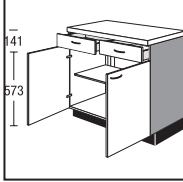
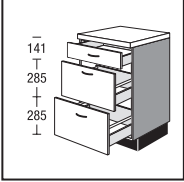
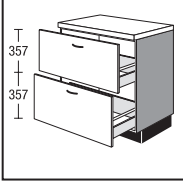
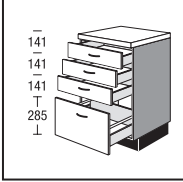
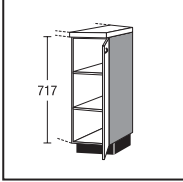
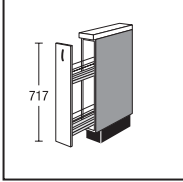
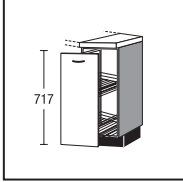
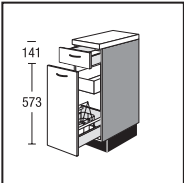
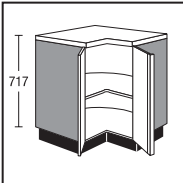
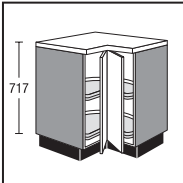
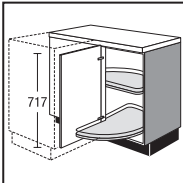
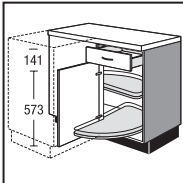
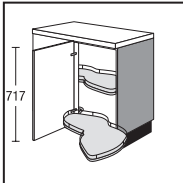
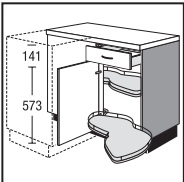
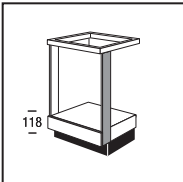
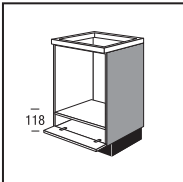
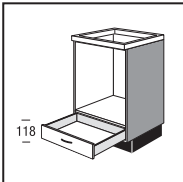
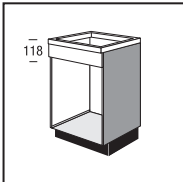
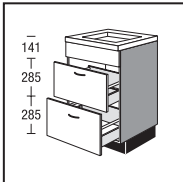
					
U15	U30 U40 U45 U50 U60	U80 U90 U100 U120	US30 US40 US45 US50 US60	US803 US903 US1003	US80 US90 US100 US120
					
US2A30 US2A40 US2A45 US2A50 US2A60 US2A80 US2A90 US2A100 US2A120	U2A30 U2A40 U2A45 U2A50 U2A60 U2A80 U2A90 U2A100 U2A120	U3SA30 U3SA40 U3SA45 U3SA50 U3SA60 U3SA80 U3SA90 U3SA100	UV25	UA15	UVA25
					
USA30ISF	UE80 UE90	UE80K UE90K	UE115K	UES115K	UE115LMP
					
UES115LMP	UHB	UHK	UHS	UHB601	KIB2A45 KIB2A50 KIB2A60 KIB2A80 KIB2A90 KIB2A100 KIB2A120

Summary of the most used/planned base units

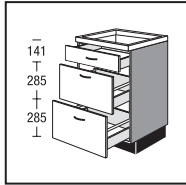

KIS2A30
KIS2A40
KIS2A45
KIS2A50
KIS2A60
KIS2A80
KIS2A90
KIS2A100
KIS2A120

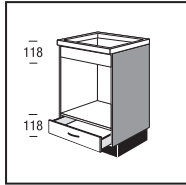

UMBS

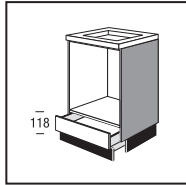

UHSW

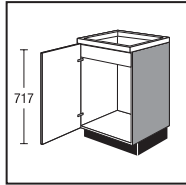

SP45
SP50
SP60

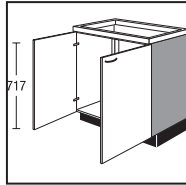

SP80
SP90
SP100
SP120

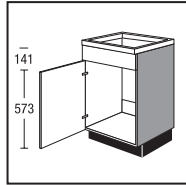

SPB40
SPB45
SPB50
SPB60

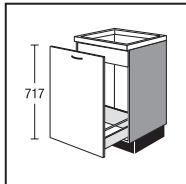

SPA45
SPA50
SPA60

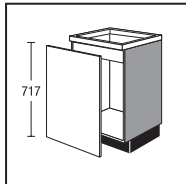

SP45T
SP50T
SP60T

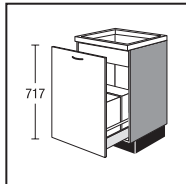

SPA50M
SPA60M

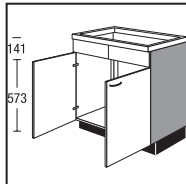

SPB80
SPB90
SPB100
SPB120

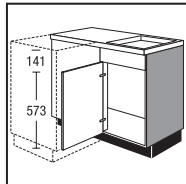

SPEB105

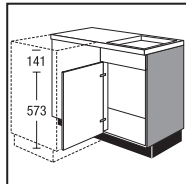

SPEB115

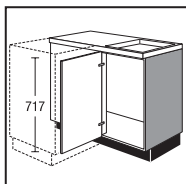

SPE105RW

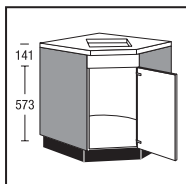

SPEBD90

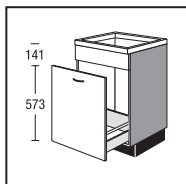

SPBA45
SPBA50
SPBA60

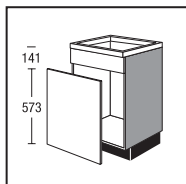

SPB45T
SPB50T
SPB60T

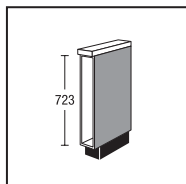

UR15

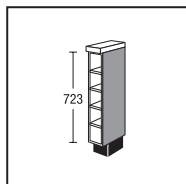

UR1533F

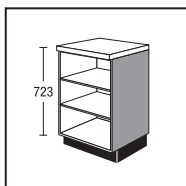

URV

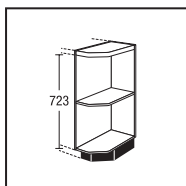

URA25S

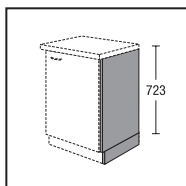

ST3
ST31

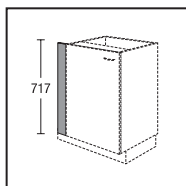

UPK10
UPK20
UPK30

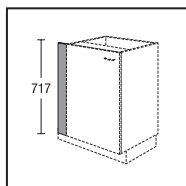

UPF10
UPF20

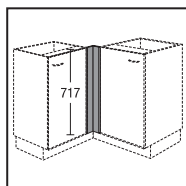

UPEF76V

Base units

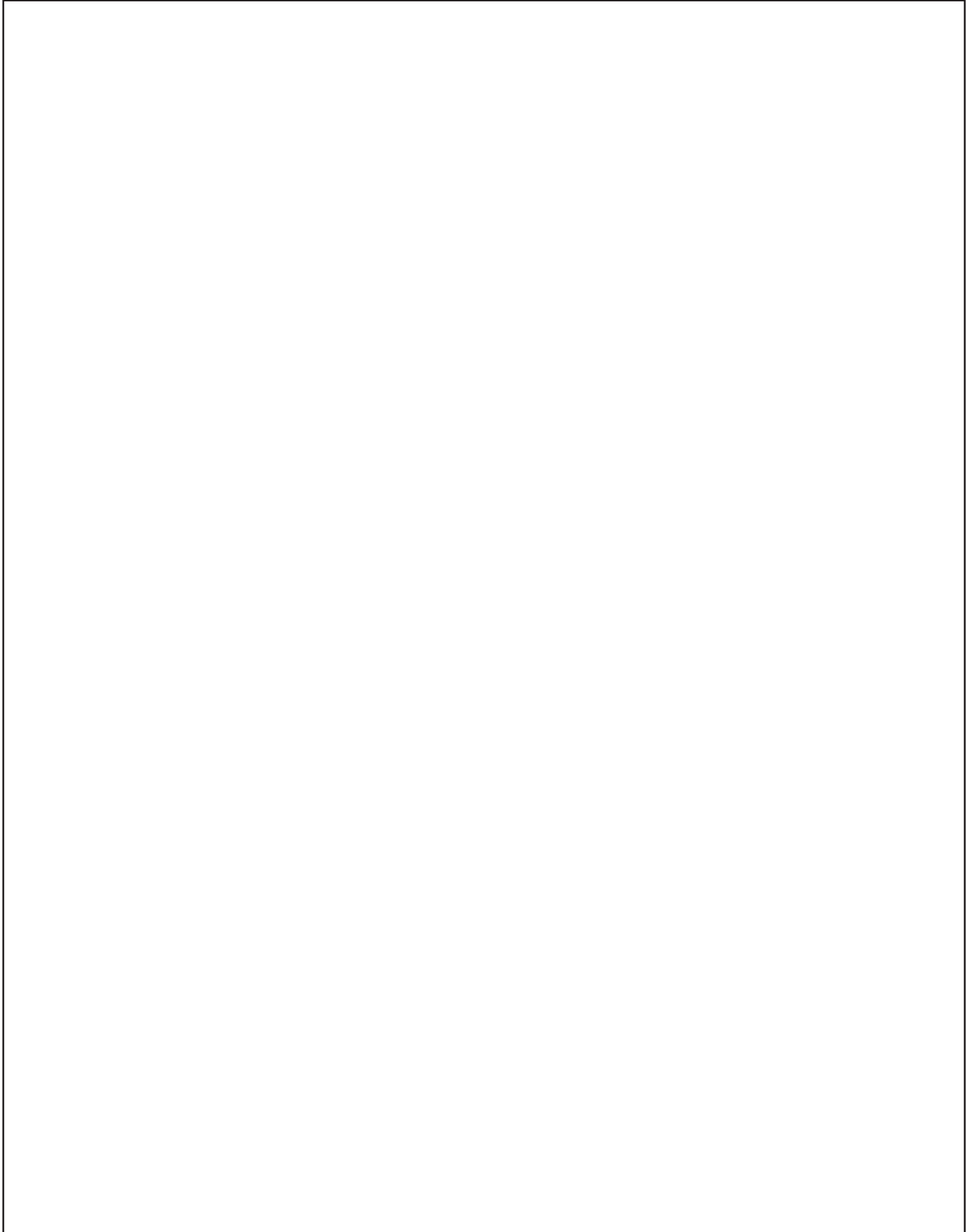

Base unit modules

147 / 291 / 363 / 435 mm high

Unit without worktop and plinth, carcass depth 560 mm

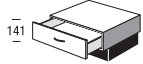
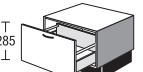
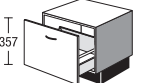
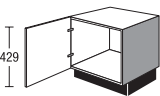
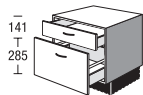
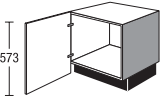
				width		Price group							Servosoft	Pro Servosoft	ProServoglass	Soft closing Top Motion	Soft closing Top Motion Plus	
						1	2	3	4	5	6	7						
	Base unit module 1 drawer	<input checked="" type="checkbox"/>	US	60	14	63	68	74	80	97	104	114	5	8	8	-	-	
	Base unit module 1 deep drawer	<input checked="" type="checkbox"/>	UA	30	29	55	62	68	74	91	98	107	5	8	16	-	-	
		<input checked="" type="checkbox"/>	UA	40	29	58	63	69	75	92	99	108	5	8	16	-	-	
		<input checked="" type="checkbox"/>	UA	45	29	61	66	72	79	95	102	112	5	8	16	-	-	
		<input checked="" type="checkbox"/>	UA	50	29	62	67	73	80	96	103	113	5	8	16	-	-	
		<input checked="" type="checkbox"/>	UA	60	29	66	71	77	84	102	109	119	5	8	16	-	-	
		<input checked="" type="checkbox"/>	UA	80	29	78	85	92	101	121	130	142	8	11	19	-	-	
		<input checked="" type="checkbox"/>	UA	90	29	81	88	96	105	126	135	147	8	11	19	-	-	
		<input checked="" type="checkbox"/>	UA	100	29	90	98	107	117	140	150	164	8	11	19	-	-	
<input checked="" type="checkbox"/>	UA	120	29	105	114	125	137	163	175	191	8	11	19	-	-			
	Base unit module 1 deep drawer	<input checked="" type="checkbox"/>	UA	50	36	72	78	84	91	111	119	130	5	8	16	-	-	
		<input checked="" type="checkbox"/>	UA	60	36	75	81	88	95	116	124	135	5	8	16	-	-	
		<input checked="" type="checkbox"/>	UA	80	36	87	95	103	113	135	145	158	8	11	19	-	-	
		<input checked="" type="checkbox"/>	UA	90	36	90	98	107	117	140	150	163	8	11	19	-	-	
		<input checked="" type="checkbox"/>	UA	100	36	99	108	118	129	154	165	180	8	11	19	-	-	
		<input checked="" type="checkbox"/>	UA	120	36	114	124	136	149	177	190	207	8	11	19	-	-	
	Base unit 1 hinged door <i>Width can be shortened down to 300 mm</i>	<input checked="" type="checkbox"/>	U	60	43	76	82	87	92	104	106	112	-	-	-	4	4	
	Base unit module 1 drawer 1 deep drawer	<input checked="" type="checkbox"/>	USA	30	43	88	98	108	118	144	155	169	10	16	24	-	-	
		<input checked="" type="checkbox"/>	USA	40	43	89	96	106	115	140	150	163	10	16	24	-	-	
		<input checked="" type="checkbox"/>	USA	45	43	95	103	113	123	149	160	174	10	16	24	-	-	
		<input checked="" type="checkbox"/>	USA	50	43	96	104	114	124	150	161	175	10	16	24	-	-	
		<input checked="" type="checkbox"/>	USA	60	43	98	106	116	126	152	163	177	10	16	24	-	-	
		<input checked="" type="checkbox"/>	USA	80	43	122	131	143	156	188	202	220	10	16	24	-	-	
		<input checked="" type="checkbox"/>	USA	90	43	127	137	149	163	197	211	229	10	16	24	-	-	
		<input checked="" type="checkbox"/>	USA	100	43	137	148	161	176	213	228	247	13	19	27	-	-	
	Base unit 1 hinged door, to floor level 2 adjustable shelves <i>Cannot be combined with handles No. 680, 700, 810 and 820.</i> <i>Only available for plinth height 155 mm.</i>	<input checked="" type="checkbox"/>	U	60	43	FV	78	84	89	94	107	109	115	-	-	-	4	4

The anti-tilt device which is supplied automatically must be fitted for room divider versions.

2.05

Base units

723 mm high

Unit without worktop and plinth, carcass depth 560 mm

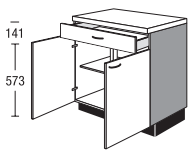
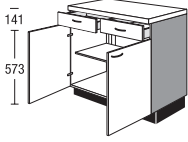
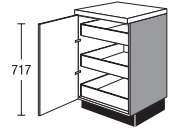
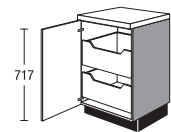
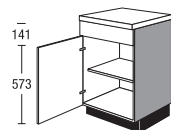
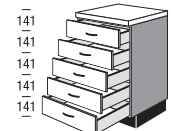
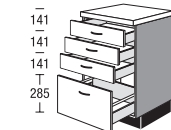
					Price group												
					width	1	2	3	4	5	6	7	Servosoft	Pro Servosoft	ProServodglass	Soft closing Top Motion	Soft closing Top Motion Plus
 <p>Base unit 1 drawer 2 hinged doors 1 adjustable shelf</p>	<input checked="" type="checkbox"/>	US	80	3	108	117	126	135	159	174	193	5	8	8	8	8	
	<input checked="" type="checkbox"/>	US	90	3	110	119	128	137	161	176	196	5	8	8	8	8	
	<input checked="" type="checkbox"/>	US	100	3	116	124	133	143	168	183	203	5	8	8	8	8	
 <p>Base unit 2 drawers 2 hinged doors 1 adjustable shelf</p>		US	80		109	118	127	136	160	175	194	10	16	16	8	8	
		US	90		111	120	129	138	162	177	197	10	16	16	8	8	
		US	100		117	125	134	144	169	184	204	10	16	16	8	8	
		US	120		146	154	163	173	198	213	234	10	16	16	8	8	
 <p>Base unit with interior drawers 1 hinged door 3 interior drawers <i>The hinged doors must open to an angle of at least 90° (observe handle spacing).</i></p>	<input checked="" type="checkbox"/>	U	30	IS	104	112	118	125	136	141	151	15	24	24	4	4	
	<input checked="" type="checkbox"/>	U	40	IS	112	121	127	134	147	152	164	15	24	24	4	4	
	<input checked="" type="checkbox"/>	U	45	IS	113	122	128	135	148	153	165	15	24	24	4	4	
	<input checked="" type="checkbox"/>	U	50	IS	116	125	132	139	151	157	168	15	24	24	4	4	
	<input checked="" type="checkbox"/>	U	60	IS	124	135	142	150	164	171	182	15	24	24	4	4	
 <p>Base unit with interior deep drawers 1 hinged door 2 interior deep drawers <i>The hinged doors must open to an angle of at least 90° (observe handle spacing).</i></p>	<input checked="" type="checkbox"/>	U	30	IA	88	95	101	108	119	130	145	10	16	32	4	4	
	<input checked="" type="checkbox"/>	U	40	IA	94	102	109	117	133	142	153	10	16	32	4	4	
	<input checked="" type="checkbox"/>	U	45	IA	95	103	110	118	134	144	155	10	16	32	4	4	
	<input checked="" type="checkbox"/>	U	50	IA	100	110	117	125	142	153	165	10	16	32	4	4	
	<input checked="" type="checkbox"/>	U	60	IA	106	116	124	132	152	155	164	10	16	32	4	4	
 <p>Base unit for fixed tables 1 fixed front panel to which table is fixed 1 hinged door 1 adjustable shelf</p>	<input checked="" type="checkbox"/>	UB	30		58	61	66	70	79	88	99	-	-	-	4	4	
	<input checked="" type="checkbox"/>	UB	40		60	65	70	75	87	94	103	-	-	-	4	4	
	<input checked="" type="checkbox"/>	UB	45		61	67	73	77	90	97	106	-	-	-	4	4	
	<input checked="" type="checkbox"/>	UB	50		64	70	76	80	92	98	107	-	-	-	4	4	
	<input checked="" type="checkbox"/>	UB	60		71	77	83	89	105	110	119	-	-	-	4	4	
 <p>Base unit 5 drawers</p>	<input checked="" type="checkbox"/>	U5S	40		108	116	121	126	153	165	181	25	40	40	-	-	
	<input checked="" type="checkbox"/>	U5S	45		109	119	127	136	156	169	186	25	40	40	-	-	
	<input checked="" type="checkbox"/>	U5S	50		110	122	130	139	159	172	190	25	40	40	-	-	
	<input checked="" type="checkbox"/>	U5S	60		115	127	137	147	171	184	201	25	40	40	-	-	
 <p>Base unit 3 drawers 1 deep drawer</p>	<input checked="" type="checkbox"/>	U3SA	30		101	107	115	124	144	156	171	20	32	40	-	-	
	<input checked="" type="checkbox"/>	U3SA	40		103	110	119	128	151	161	175	20	32	40	-	-	
	<input checked="" type="checkbox"/>	U3SA	45		105	112	121	130	154	164	178	20	32	40	-	-	
	<input checked="" type="checkbox"/>	U3SA	50		106	115	124	133	157	168	182	20	32	40	-	-	
	<input checked="" type="checkbox"/>	U3SA	60		110	122	132	142	168	179	194	20	32	40	-	-	
	<input checked="" type="checkbox"/>	U3SA	80		169	187	203	218	258	275	298	32	44	52	-	-	
	<input checked="" type="checkbox"/>	U3SA	90		178	197	214	230	272	290	314	32	44	52	-	-	
	<input checked="" type="checkbox"/>	U3SA	100		186	206	223	240	284	303	328	32	44	52	-	-	

The anti-tilt device which is supplied automatically must be fitted for room divider versions.

Base units

723 mm high

Unit without worktop and plinth, carcass depth 560 mm

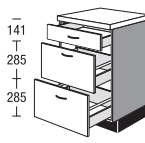
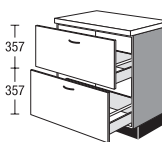
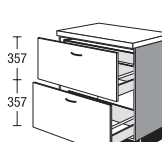
			width	Price group							Servosoft	Pro Servosoft	ProServoGlass	Soft closing Top Motion	Soft closing Top Motion Plus			
				1	2	3	4	5	6	7								
 <p>Base unit</p> <p>1 drawer 2 deep drawers</p> <p>same as above, but with Servosoft / Pro Servosoft</p> <p>same as above, but with Servosoft / Pro Servosoft</p> <p><i>Plinth feet are supplied loose.</i></p>	<input checked="" type="checkbox"/>	US2A	30			98	106	113	121	135	146	161	15	24	40	-	-	
	<input checked="" type="checkbox"/>	US2A	40			101	108	114	122	136	146	161	15	24	40	-	-	
	<input checked="" type="checkbox"/>	US2A	45			105	112	119	127	141	152	167	15	24	40	-	-	
	<input checked="" type="checkbox"/>	US2A	50			106	115	122	130	146	156	170	15	24	40	-	-	
	<input checked="" type="checkbox"/>	US2A	60			111	123	129	136	157	169	186	15	24	40	-	-	
	<input checked="" type="checkbox"/>	US2A	80			154	165	174	183	207	223	244	21	30	46	-	-	
	<input checked="" type="checkbox"/>	US2A	90			156	167	176	185	209	225	246	21	30	46	-	-	
	<input checked="" type="checkbox"/>	US2A	100			170	182	192	202	228	245	268	21	30	46	-	-	
	<input checked="" type="checkbox"/>	US2A	120			209	224	236	248	280	301	329	21	30	46	-	-	
	<input checked="" type="checkbox"/>	460	US2A	30	72	46	123	131	138	146	160	171	187	15	24	40	-	-
	<input checked="" type="checkbox"/>	460	US2A	40	72	46	126	133	139	147	161	171	187	15	24	40	-	-
	<input checked="" type="checkbox"/>	460	US2A	45	72	46	130	137	144	152	166	177	193	15	24	40	-	-
	<input checked="" type="checkbox"/>	460	US2A	50	72	46	131	140	147	155	171	181	196	15	24	40	-	-
	<input checked="" type="checkbox"/>	460	US2A	60	72	46	136	148	154	161	182	194	212	15	24	40	-	-
	<input checked="" type="checkbox"/>	326	US2A	30	72	33	123	131	138	146	160	171	187	15	24	40	-	-
	<input checked="" type="checkbox"/>	326	US2A	40	72	33	126	133	139	147	161	171	187	15	24	40	-	-
	<input checked="" type="checkbox"/>	326	US2A	45	72	33	130	137	144	152	166	177	193	15	24	40	-	-
	<input checked="" type="checkbox"/>	326	US2A	50	72	33	131	140	147	155	171	181	196	15	24	40	-	-
	<input checked="" type="checkbox"/>	326	US2A	60	72	33	136	148	154	161	182	194	212	15	24	40	-	-
 <p>Base unit</p> <p>2 deep drawers</p> <p>Available for the following ranges: IP 1200, IP 2200, IP 3150, IP 4050</p> <p>Base unit</p> <p>2 deep drawers</p>	<input checked="" type="checkbox"/>	U2A	30			97	105	112	120	134	145	159	10	16	32	-	-	
	<input checked="" type="checkbox"/>	U2A	40			100	107	113	121	135	145	159	10	16	32	-	-	
	<input checked="" type="checkbox"/>	U2A	45			103	110	117	125	138	149	164	10	16	32	-	-	
	<input checked="" type="checkbox"/>	U2A	50			104	115	122	128	149	160	176	10	16	32	-	-	
	<input checked="" type="checkbox"/>	U2A	60			112	124	131	138	160	172	189	10	16	32	-	-	
	<input checked="" type="checkbox"/>	U2A	80			155	166	173	184	207	223	245	16	22	38	-	-	
	<input checked="" type="checkbox"/>	U2A	90			161	172	180	191	215	232	255	16	22	38	-	-	
	<input checked="" type="checkbox"/>	U2A	100			169	181	189	201	225	244	268	16	22	38	-	-	
	<input checked="" type="checkbox"/>	U2A	120			207	223	234	251	275	299	328	16	22	38	-	-	
	 <p>Base unit with interior drawer</p> <p>1 deep drawer 1 internal drawer 1 deep drawer</p> <p>Order carrier for interior drawers separately. Item ZIS 1 (1 unit included)</p> <p>Available for the following ranges: IP 1200, IP 2200, IP 3150, IP 4050</p> <p>Base unit with interior drawer</p> <p>1 deep drawer 1 internal drawer 1 deep drawer</p> <p>Order carrier for interior drawers separately. Item ZIS 1 (1 unit included)</p> <p>Suitable additions:</p> <p>Carrier for interior drawer / interior deep drawer</p> <p>for screwing on the front panel 1 each</p> <p>Cannot be used on the following ranges: IP 4820, IP 7500</p>	<input checked="" type="checkbox"/>	U2A	30	IS		118	127	134	141	161	163	190	15	24	40	-	-
<input checked="" type="checkbox"/>		U2A	40	IS		126	135	143	151	172	174	203	15	24	40	-	-	
<input checked="" type="checkbox"/>		U2A	45	IS		131	141	149	157	179	181	211	15	24	40	-	-	
<input checked="" type="checkbox"/>		U2A	50	IS		137	147	156	164	187	189	221	15	24	40	-	-	
<input checked="" type="checkbox"/>		U2A	60	IS		146	157	166	175	199	201	236	15	24	40	-	-	
<input checked="" type="checkbox"/>		U2A	80	IS		178	190	199	209	235	253	275	21	30	46	-	-	
<input checked="" type="checkbox"/>		U2A	90	IS		199	210	219	228	252	254	291	21	30	46	-	-	
<input checked="" type="checkbox"/>		U2A	100	IS		215	225	234	242	265	270	307	21	30	46	-	-	
<input checked="" type="checkbox"/>		U2A	120	IS		246	257	268	277	303	309	351	21	30	46	-	-	
			ZIS 1				2	2	2	2	2	2	2	-	-	-	-	-

2.08 The anti-tilt device which is supplied automatically must be fitted for room divider versions.

Base units

723 mm high

Unit without worktop and plinth, carcass depth 560 mm

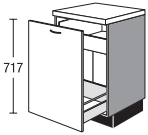
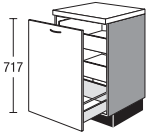
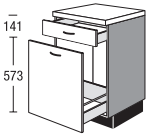
				width	Price group							Servosoft	Pro Servosoft	ProServodglass	Soft closing Top Motion	Soft closing Top Motion Plus	
					1	2	3	4	5	6	7						
 <p>717</p>	Base unit with interior drawer 1 deep drawer 1 internal drawer <i>Order carrier for interior drawers separately. Item ZIS 1 (1 unit included)</i>	<input checked="" type="checkbox"/>	UA	30	IS	89	95	100	106	117	125	136	10	16	24	-	-
		<input checked="" type="checkbox"/>	UA	45	IS	94	99	104	111	122	130	142	10	16	24	-	-
		<input checked="" type="checkbox"/>	UA	50	IS	98	105	110	117	130	137	149	10	16	24	-	-
		<input checked="" type="checkbox"/>	UA	60	IS	103	112	117	123	140	150	163	10	16	24	-	-
Suitable additions: Carrier for interior drawer / interior deep drawer for screwing on the front panel 1 each <i>Cannot be used on the following ranges: IP 4820, IP 7500</i>			ZIS 1			2	2	2	2	2	2	2	-	-	-	-	-
 <p>717</p>	Base unit with interior drawers 1 deep drawer 2 internal drawers <i>Carriers for interior drawers must be ordered separately. Item ZIS 1 (1 unit included)</i>	<input checked="" type="checkbox"/>	UA	30	2IS	106	114	120	127	139	144	154	15	24	32	-	-
		<input checked="" type="checkbox"/>	UA	45	2IS	115	124	130	137	151	156	168	15	24	32	-	-
		<input checked="" type="checkbox"/>	UA	50	2IS	118	127	134	141	154	160	171	15	24	32	-	-
		<input checked="" type="checkbox"/>	UA	60	2IS	126	137	144	152	167	174	186	15	24	32	-	-
Suitable additions: Carrier for interior drawer / interior deep drawer for screwing on the front panel 1 each <i>Cannot be used on the following ranges: IP 4820, IP 7500</i>			ZIS 1			2	2	2	2	2	2	2	-	-	-	-	-
 <p>141 573</p>	Base unit 1 drawer 1 deep drawer	<input checked="" type="checkbox"/>	USA	30		91	97	102	109	120	129	140	10	16	24	-	-
		<input checked="" type="checkbox"/>	USA	45		96	102	107	114	125	134	147	10	16	24	-	-
		<input checked="" type="checkbox"/>	USA	50		100	107	112	120	133	141	152	10	16	24	-	-
		<input checked="" type="checkbox"/>	USA	60		105	115	120	126	144	154	168	10	16	24	-	-

The anti-tilt device which is supplied automatically must be fitted for room divider versions.

2.09

Base units

723 mm high

Unit without worktop and plinth, carcass depth 560 mm

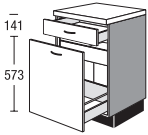
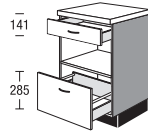
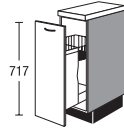
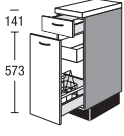





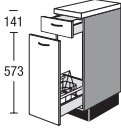
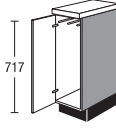
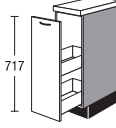

			width		Price group							Servosoft	Pro Servosoft	ProServoGlass	Soft closing Top Motion	Soft closing Top Motion Plus
					1	2	3	4	5	6	7					
 <p>Base unit with interior drawer</p> <p>1 drawer 1 deep drawer 1 internal drawer</p> <p><i>Order carrier for interior drawers separately. Item ZIS 1 (1 unit included)</i></p> <p>Suitable additions:</p> <p>Carrier for interior drawer / interior deep drawer for screwing on the front panel 1 each</p> <p><i>Cannot be used on the following ranges: IP 4820, IP 7500</i></p>	<input checked="" type="checkbox"/>	USA	30	IS	109	117	123	131	143	148	159	15	24	32	-	-
	<input checked="" type="checkbox"/>	USA	45	IS	118	127	133	141	155	160	172	15	24	32	-	-
	<input checked="" type="checkbox"/>	USA	50	IS	121	130	137	145	158	164	175	15	24	32	-	-
	<input checked="" type="checkbox"/>	USA	60	IS	129	140	147	156	171	178	190	15	24	32	-	-
	ZIS 1												-	-	-	-
 <p>Base unit</p> <p>1 drawer 1 open compartment 1 deep drawer</p> <p><i>Unit interior in carcass decor. Not available in visible side colours.</i></p>	<input checked="" type="checkbox"/>	USA	45	RMA	133	142	151	161	179	193	212	10	16	24	-	-
	<input checked="" type="checkbox"/>	USA	50	RMA	139	151	160	170	191	205	223	10	16	24	-	-
	<input checked="" type="checkbox"/>	USA	60	RMA	148	164	173	182	211	227	250	10	16	24	-	-
 <p>Base unit for baguettes</p> <p>1 deep drawer with basket insert and pocket for baguettes</p> <p><i>Wire parts silver grey Handle arrangement only horizontal</i></p>		UA	30	B	135	141	146	151	162	172	185	5	8	8	-	-
 <p>Base unit for bottles</p> <p>1 drawer 1 deep drawer 1 internal drawer 1 removable bottle basket</p> <p><i>Order carrier for interior drawers separately. Item ZIS 1 (1 unit included)</i></p> <p>Suitable additions:</p> <p>Carrier for interior drawer / interior deep drawer for screwing on the front panel 1 each</p> <p><i>Cannot be used on the following ranges: IP 4820, IP 7500</i></p>		USA	30	ISF	115	128	134	141	155	166	181	15	24	32	-	-
	ZIS 1															

2.10 The anti-tilt device which is supplied automatically must be fitted for room divider versions.

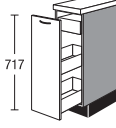
Base units

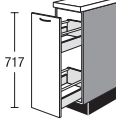
723 mm high

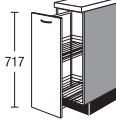
Unit without worktop and plinth, carcass depth 560 mm

				Price group													
				width	1	2	3	4	5	6	7	Servosoft	Pro Servosoft	ProServoglass	Soft closing Top Motion	Soft closing Top Motion Plus	
	Base unit for bottles 1 drawer 1 deep drawer 1 removable bottle basket	USA		30	F	98	106	113	120	135	146	161	10	16	24	-	-
	Base unit for towels 1 hinged door 1 towel rail, extendable on roller guides	U		30	H	64	68	72	76	83	90	99	-	-	-	4	4
	Base unit 1 deep drawer with 2 drawers	 UA  UA		30 40	S S	78 85	84 91	89 97	95 103	106 115	114 124	124 136	10 10	16 16	16 16	-	-
	Base unit 1 deep drawer with 2 drawers 1 internal drawer	 UA  UA		30 40	SIS SIS	104 111	112 119	118 126	125 133	136 146	141 151	151 161	15 15	24 24	24 24	-	-
	Base unit 1 Auszug mit 2 Auszügen	 UA  UA		30 40	A A	84 91	90 97	96 104	102 110	114 123	123 133	134 146	10 10	16 16	32 32	-	-
 	Larder base unit 1 full-extension pull-out with cushioning 2 adjustable baskets <i>Wire parts silver grey</i> <i>Handle arrangement only horizontal</i> <i>R/h hinge = runner on the r/h side</i> <i>L/h hinge = runner on the l/h side</i> <i>Equipment feature baskets:</i> <i>wire parts silver grey</i>	UA		30		139	145	150	155	165	175	187	-	-	-	-	-
	Suitable additions: Hanging basket silver-grey 2 each	ZIK 30 S2 2 each				10	10	10	10	10	10	10	-	-	-	-	-





The anti-tilt device which is supplied automatically must be fitted for room divider versions.

2.11

Base units

723 mm high

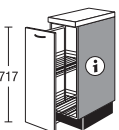
Unit without worktop and plinth, carcass depth 560 mm

		width	Price group							Servosoft	Pro Servosoft	ProServoGlass	Soft closing Top Motion	Soft closing Top Motion Plus	
			1	2	3	4	5	6	7						
 <p>Base unit Dispensa Junior III 1 full-extension pull-out with cushioning, 2 baskets included</p> <p><i>Runner profile top and bottom Baskets can be used from both sides.</i></p> <p><i>Equipment feature baskets: wire parts silver grey</i></p> <p><i>Handle arrangement only horizontal</i></p> <p><i>Supplementary unit information: Including full pull-out with cushioning</i></p> <p><i>Note unit information.</i></p>  <p>Baskets: clip-on baskets silver grey</p>	UA	30	J	156	163	169	175	187	199	214	-	-	-	-	
	Suitable additions:														
	Insert tray plastic white 12 mm high	ZIE	30		3	3	3	3	3	3	3	3	-	-	-
Hanging basket silver-grey	ZIK	30		6	6	6	6	6	6	6	6	-	-	-	
 <p>Base unit Dispensa Junior III 1 full-extension pull-out with cushioning, 2 baskets included</p> <p><i>Runner profile top and bottom Baskets can be used from both sides.</i></p> <p><i>Basket features: Comfortline, wooden base with metal railing</i></p> <p><i>Handle arrangement only horizontal</i></p> <p><i>Supplementary unit information: Including full pull-out with cushioning</i></p> <p><i>Note unit information.</i></p>  <p>Baskets: wooden shelf and metal rail</p>	UA	30	JP	162	170	176	182	195	207	222	-	-	-	-	
	Suitable additions:														
Hanging basket Wooden shelf with metal rail	ZIK	30	P	7	7	7	7	7	7	7	7	-	-	-	
 <p>Deep drawer unit 1 full-extension pull-out with cushioning, 2 baskets included</p> <p><i>Wire parts silver grey</i></p> <p><i>Handle only fitted vertically</i></p>	UA	15		134	139	144	149	159	169	181	-	-	-	-	

2.12 The anti-tilt device which is supplied automatically must be fitted for room divider versions.

Base units, Base units with table

723 mm high

Unit without worktop and plinth, carcass depth 560 mm

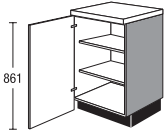
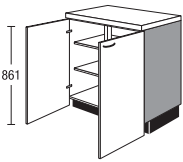
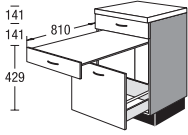
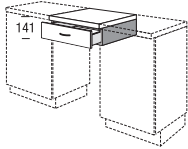
				Price group												
				width	1	2	3	4	5	6	7	Servosoft	Pro Servosoft	ProServoglass	Soft closing Top Motion	Soft closing Top Motion Plus
 <p>Base unit 1 hinged door, to floor level 2 adjustable shelves <i>Cannot be combined with handles No. 680, 700, 810 and 820.</i> <i>Only available for plinth height 155 mm.</i></p>	U	30	FV	62	67	71	76	84	92	102	-	-	-	4	4	
	U	40	FV	63	67	72	77	87	94	102	-	-	-	4	4	
	U	45	FV	66	72	76	82	93	100	108	-	-	-	4	4	
	U	50	FV	68	75	80	85	97	104	112	-	-	-	4	4	
	U	60	FV	73	80	85	91	104	107	112	-	-	-	4	4	
 <p>Base unit 2 hinged doors, to floor level 2 adjustable shelves <i>Cannot be combined with handles No. 680, 700, 810 and 820.</i> <i>Only available for plinth height 155 mm.</i></p>	U	80	FV	108	121	131	142	162	176	194	-	-	-	8	8	
	U	90	FV	115	128	138	148	170	186	206	-	-	-	8	8	
	U	100	FV	121	129	139	150	174	191	213	-	-	-	8	8	
	U	120	FV	154	163	173	184	210	227	251	-	-	-	8	8	
 <p>Base unit with pull-out table 1 drawer 1 pull-out tabletop on telescopic tracks without support base 1 deep drawer Table surface white <i>Size of the extended pullout table approx. 810 x 550 mm</i> <i>Table height for 105 mm plinth 641 mm</i> <i>max. load-bearing capacity 30 kg</i></p>	USA	60	T	213	239	244	250	259	271	296	10	16	24	-	-	
 <p>Built-under drawer below worktop 147 mm high</p>	<input checked="" type="checkbox"/>	MS	45	14	53	57	59	61	62	64	68	5	8	8	-	-
	<input checked="" type="checkbox"/>	MS	50	14	54	58	60	62	63	65	69	5	8	8	-	-
	<input checked="" type="checkbox"/>	MS	60	14	55	59	61	63	64	66	70	5	8	8	-	-

The anti-tilt device which is supplied automatically must be fitted for room divider versions.

2.13

Base units

723 mm high

Unit without worktop and plinth, Carcase depth 326 mm

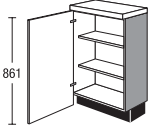
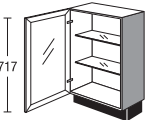
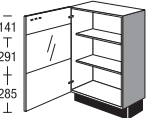
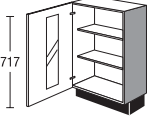
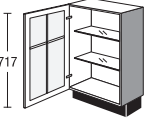



			width	Price group							Servosoft	Pro Servosoft	ProServoGlass	Soft closing Top Motion	Soft closing Top Motion Plus		
				1	2	3	4	5	6	7							
 <p>Base unit</p> <p>1 hinged door, to floor level 2 adjustable shelves</p> <p>Cannot be combined with handles No. 680, 700, 810 and 820.</p> <p>Only available for plinth height 155 mm.</p> <p>Plinth feet are supplied loose.</p>	326	U	30	72	33FV	81	85	89	93	100	108	118	-	-	-	4	4
	326	U	40	72	33FV	84	88	92	97	107	113	121	-	-	-	4	4
	326	U	45	72	33FV	85	90	94	99	110	116	124	-	-	-	4	4
	326	U	50	72	33FV	86	92	96	101	112	118	126	-	-	-	4	4
	326	U	60	72	33FV	92	98	103	108	121	123	129	-	-	-	4	4
 <p>Base unit with glass door</p> <p>1 glass door 2 adjustable glass shelves</p> <p>Handles can only be mounted vertically on framed glass doors Handle can only be fitted horizontally on segment glass doors</p> <p>Framed glass door No. 701</p> <p>Assembly of handles nos. 740, 760, 780, 790 and 800 only horizontal, centred</p>	326	UG	45	72	33	92	99	100	102	110	118	128	-	-	-	4	4
	326	UG	50	72	33	94	101	102	104	113	121	133	-	-	-	4	4
	326	UG	60	72	33	97	105	107	109	118	127	139	-	-	-	4	4
 <p>For glass and frame finishes please refer to programme summary</p> <p>For available versions see overview Possible glass front versions</p> <p>Plinth feet are supplied loose.</p> <p>Segmented glass door No. 706</p>																	
 <p>Framed glass door No. 704</p>																	
 <p>Glass door with glazing bars No. 705</p>																	

2.14 The anti-tilt device which is supplied automatically must be fitted for room divider versions.

Corner base units

723 mm high

Unit without worktop and plinth, carcass depth 560 mm





		width	Price group							Servosoft	Pro Servosoft	ProServoglass	Soft closing Top Motion	Soft closing Top Motion Plus	
			1	2	3	4	5	6	7						
 <p>Corner base unit 2 hinged doors 1 fixed shelf <i>UE 80: Handle only fitted vertically</i> <i>Assembly of handles nos. 740, 760, 780, 790 and 800 only horizontal, centred</i> <i>Unit can be dismantled on site</i></p>	UE	80		161	171	177	183	188	194	206	-	-	-	8	8
	UE	90		177	188	194	201	207	214	229	-	-	-	8	8
 <p>Corner base unit Divided inwards pivoting door with cushioning 2 wooden carousel shelves with metal rail <i>UE 80 KP: Handle only fitted vertically on right door</i> <i>Assembly of handles nos. 740, 760, 780, 790 and 800 only horizontal, centred</i> <i>Unit can be dismantled on site</i></p> 	UE	80	KP	254	268	277	286	293	301	320	-	-	-	-	-
	UE	90	KP	268	282	291	300	309	319	341	-	-	-	-	-
 <p>Corner base unit same as above, but split pivoting doors Carousel with 2 plastic carousel shelves</p> 	UE	80	K	189	203	212	221	228	236	252	-	-	-	-	-
	UE	90	K	201	215	224	233	242	252	270	-	-	-	-	-

The anti-tilt device which is supplied automatically must be fitted for room divider versions.

Corner base units

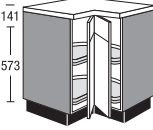
723 mm high

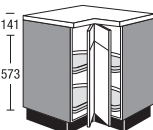
Unit without worktop and plinth, carcass depth 560 mm

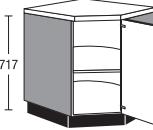
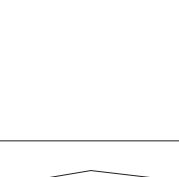
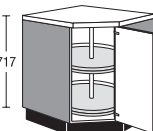
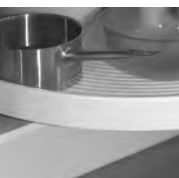
		width	Price group							Servosoft	Pro Servosoft	ProServoGlass	Soft closing Top Motion	Soft closing Top Motion Plus	
			1	2	3	4	5	6	7						
 <p>Corner base unit Split swivel doors (dowelled) with soft closure 2 wooden carousel shelves with metal rail and rotating damping</p> <p><i>Not available for the following ranges: IP 4820, IP 7500</i></p> <p><i>Handle No. 740, 780 and 790 can only be fitted horizontally, centred</i></p> <p><i>Unit can be dismantled on site</i></p>	UE	90	KPMS	284	299	308	318	327	338	361	-	-	-	-	-
															
 <p>Corner base unit same as above, but Carousel with 2 plastic carousel shelves</p>	UE	90	KMS	230	246	256	267	277	288	309	-	-	-	-	-
															
 <p>Corner base unit 1 hinged door 1 fixed shelf</p> <p><i>An oven housing unit cannot be planned next to this corner unit due to worktop connection problems.</i></p> <p><i>Matching corner worktop PLR/PLS 4390 60</i></p> <p><i>Requires 780 mm wide door opening, however unit can be dismantled on site.</i></p>	UED	90		167	180	183	186	204	214	227	-	-	-	4	4
															
 <p>Corner base unit 1 hinged door Carousel with 2 plastic carousel shelves</p> <p><i>An oven housing unit cannot be planned next to this corner unit due to worktop connection problems.</i></p> <p><i>Matching corner worktop PLR/PLS 4390 60</i></p> <p><i>Requires 780 mm wide door opening, however unit can be dismantled on site.</i></p>	UED	90	K	182	195	198	201	219	229	242	-	-	-	4	4
															

2.16 The anti-tilt device which is supplied automatically must be fitted for room divider versions.

Corner base units

723 mm high

Unit without worktop and plinth, carcass depth 560 mm

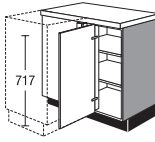
		Price group												
		width	1	2	3	4	5	6	7	Servosoft	Pro Servosoft	ProServodglass	Soft closing Top Motion	Soft closing Top Motion Plus
 <p>Version L</p>	<p>Corner base unit with smooth add-on panel and loose infill panel, in door finish or door colour for adding base units 1 hinged door 2 adjustable shelves</p> <p><i>Planning dimensions 950 x 650 mm Carcass width 600 mm</i></p> <p><i>Setting forward for compensation of dimensions possible. (Minimum dimensions: 885 x 600 mm)</i></p> <p><i>When planning kitchens with a dishwasher next to the corner unit, the corner trim is supplied with return. Opening areas of appliances and drawers must be taken into account when planning smaller dimensions.</i></p> <p><i>An additional infill panel must be ordered for planning dimensions over 650 mm.</i></p> <p><i>Order hinged door opening limited Z19 separately if required.</i></p>	UE 95 with 30 cm door	97	107	117	127	135	149	168	-	-	-	4	4
	<p>Corner base unit same as above, but</p> <p><i>Planning dimension 1050 x 650 mm Carcass width 900 mm</i></p> <p><i>May be pulled forward to balance dimensions. (minimum dimension: 985 x 600 mm)</i></p>	UE 105 with 40 cm door	104	114	124	134	142	156	175	-	-	-	4	4
	<p>Corner base unit same as above, but</p> <p><i>Planning dimension 1100 x 650 mm Carcass width 900 mm</i></p> <p><i>May be pulled forward to balance dimensions. (minimum dimension: 1035 x 600 mm)</i></p>	UE 110 with 45 cm door	107	117	128	138	146	161	180	-	-	-	4	4
	<p>Corner base unit same as above, but</p> <p><i>Planning dimension 1150 x 650 mm Carcass width 1000 mm</i></p> <p><i>May be pulled forward to balance dimensions. (minimum dimension: 1085 x 600 mm)</i></p>	UE 115 with 50 cm door	108	116	126	136	144	158	177	-	-	-	4	4
	<p>Corner base unit same as above, but</p> <p><i>Planning dimension 1250 x 650 mm Carcass width 1000 mm</i></p> <p><i>May be pulled forward to balance dimensions. (minimum dimension: 1185 x 600 mm)</i></p>	UE 125 with 60 cm door	108	116	126	136	144	158	177	-	-	-	4	4

The anti-tilt device which is supplied automatically must be fitted for room divider versions.

Corner base units

723 mm high

Unit without worktop and plinth, carcass depth 560 mm

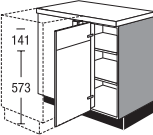
	width	Price group							Servosoft	Pro Servosoft	ProServoGlass	Soft closing Top Motion	Soft closing Top Motion Plus	
		1	2	3	4	5	6	7						
 <p>Version L</p> <p>Corner base unit with smooth add-on panel and loose infill panel, in door finish or door colour for adding base units 1 door (dowelled) 2 adjustable shelves</p> <p><i>Planning dimensions 950 x 650 mm Carcass width 600 mm</i></p> <p><i>Setting forward for compensation of dimensions possible. (Minimum dimensions: 885 x 600 mm)</i></p> <p><i>When planning kitchens with a dishwasher next to the corner unit, the corner trim is supplied with return. Opening areas of appliances and drawers must be taken into account when planning smaller dimensions.</i></p> <p><i>An additional infill panel must be ordered for planning dimensions over 650 mm.</i></p> <p><i>Order hinged door opening limited Z19 separately if required.</i></p>	95	MS	98	108	118	128	136	150	169	-	-	-	4	4
	105	MS	106	116	126	136	144	158	177	-	-	-	4	4
	110	MS	110	120	131	141	149	164	184	-	-	-	4	4
	115	MS	111	119	129	139	147	161	180	-	-	-	4	4
	125	MS	111	119	129	139	147	161	180	-	-	-	4	4

2.18 The anti-tilt device which is supplied automatically must be fitted for room divider versions.

Corner base units

723 mm high

Unit without worktop and plinth, carcass depth 560 mm

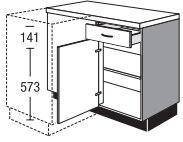
		width	Price group							Servosoft	Pro Servosoft	ProServoglass	Soft closing Top Motion	Soft closing Top Motion Plus		
			1	2	3	4	5	6	7							
 <p>Version L</p>	Corner base unit	UES with 40 cm door	105	121	129	139	149	157	172	191	5	8	8	4	4	
	<p>with smooth built-in panel and loose infill panel 50 mm wide in door finish or door colour for adding on base units</p> <p>1 drawer 1 hinged door 1 adjustable shelf</p> <p><i>Planning dimension 1050 x 650 mm Carcass width 900 mm</i></p> <p><i>May be pulled forward to balance dimensions. (minimum dimension: 985 x 600 mm)</i></p> <p><i>The corner infill panel is supplied with returns for kitchens planned with adjacent dishwasher. Opening areas of appliances and drawers must be taken into account when planning smaller dimensions.</i></p> <p><i>An additional infill panel must be ordered for planning dimensions over 650 mm.</i></p> <p><i>Order hinged door opening limited Z19 separately if required.</i></p>															
	Corner base unit		UES	110	125	133	143	154	162	177	197	5	8	8	4	4
	<p>same as above, but</p> <p><i>Planning dimension 1100 x 650 mm Carcass width 900 mm</i></p> <p><i>May be pulled forward to balance dimensions. (minimum dimension: 1035 x 600 mm)</i></p>															
Corner base unit		UES	115	122	130	140	150	158	173	192	5	8	8	4	4	
<p>same as above, but</p> <p><i>Planning dimension 1150 x 650 mm Carcass width 1000 mm</i></p> <p><i>May be pulled forward to balance dimensions. (minimum dimension: 1085 x 600 mm)</i></p>																
Corner base unit		UES	125	132	141	151	162	171	187	208	5	8	8	4	4	
<p>same as above, but</p> <p><i>Planning dimension 1250 x 650 mm Carcass width 1000 mm</i></p> <p><i>May be pulled forward to balance dimensions. (minimum dimension: 1185 x 600 mm)</i></p>																





The anti-tilt device which is supplied automatically must be fitted for room divider versions.

2.19

Corner base units

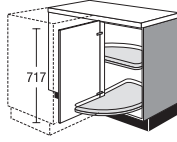
723 mm high

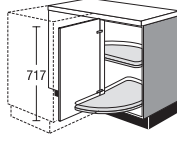
Unit without worktop and plinth, carcass depth 560 mm



		width	Price group							Servosoft	Pro Servosoft	ProServoGlass	Soft closing Top Motion	Soft closing Top Motion Plus		
			1	2	3	4	5	6	7							
 <p>717</p> <p>Version L</p>	<p>Corner base unit with smooth mounting panel and loose panel 50 mm wide, in door colour for mounting base units 1 hinged door 2 wooden carousel shelves with metal rail</p> <p><i>Planning dimension 1150 x 650 mm</i> <i>Carcass width 1000 mm</i></p> <p><i>May be pulled forward to balance dimensions.</i> <i>(minimum dimension: 1085 x 600 mm)</i></p> <p><i>The corner infill panel is supplied with</i> <i>returns for kitchens planned with adjacent</i> <i>dishwasher.</i> <i>Opening areas of appliances and drawers</i> <i>must be taken into account when planning</i> <i>smaller dimensions.</i></p> <p><i>An additional infill panel must be ordered for</i> <i>planning dimensions over 650 mm.</i></p> <p><i>Order hinged door opening limited Z19</i> <i>separately if required.</i></p>	UE	115	KP	178	189	197	205	219	234	256	-	-	-	4	4
																
 <p>717</p> <p>Version L</p>	<p>Corner base unit same as above, but 2 laminate swing-out shelves</p>	UE	115	K	118	129	137	145	159	174	194	-	-	-	4	4
																

2.20 The anti-tilt device which is supplied automatically must be fitted for room divider versions.

Corner base units

723 mm high

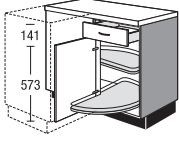
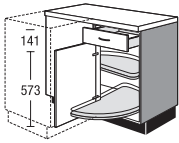
Unit without worktop and plinth, carcass depth 560 mm

		width	Price group							Servosoft	Pro Servosoft	ProServoglass	Soft closing Top Motion	Soft closing Top Motion Plus		
			1	2	3	4	5	6	7							
 <p>141 573</p>	<p>Corner base unit with drawer</p> <p>with smooth mounting panel and loose panel 50 mm wide, in door colour for mounting base units</p> <p>1 drawer</p> <p>1 hinged door</p> <p>2 wooden carousel shelves with metal rail</p>	UES	115	KP	192	203	211	219	233	249	271	5	8	8	4	4
	<p>Version L</p> <p>Planning dimension 1150 x 650 mm Carcass width 1000 mm</p> <p>May be pulled forward to balance dimensions. (minimum dimension: 1085 x 600 mm)</p> <p>The corner infill panel is supplied with returns for kitchens planned with adjacent dishwasher. Opening areas of appliances and drawers must be taken into account when planning smaller dimensions.</p> <p>An additional infill panel must be ordered for planning dimensions over 650 mm.</p> <p>Order hinged door opening limited Z19 separately if required.</p>															
 <p>141 573</p>	<p>Corner base unit with drawer</p> <p>same as above, but</p> <p>2 laminate swing-out shelves</p>	UES	115	K	132	143	151	159	173	189	208	5	8	8	4	4
	<p>Version L</p> 															

The anti-tilt device which is supplied automatically must be fitted for room divider versions.

Corner base units

723 mm high

Unit without worktop and plinth, carcass depth 560 mm

		width	Price group							Servosoft	Pro Servosoft	ProServoGlass	Soft closing Top Motion	Soft closing Top Motion Plus		
			1	2	3	4	5	6	7							
	<p>Corner base unit with smooth built-in panel and loose infill panel 50 mm wide in door finish or door colour for adding on base units 1 hinged door 2 fully pivotable wooden carousel shelves with LeMans metal rail with self-closing mechanism and cushioning effect</p> <p><i>Planning dimension 1100 x 650 mm Carcase width 900 mm</i></p> <p><i>May be pulled forward to balance dimensions. (minimum dimension: 1100 x 600 mm)</i></p> <p><i>Minimum planning dimension 1100 mm must be observed.</i></p> <p><i>The corner infill panel is supplied with returns for kitchens planned with adjacent dishwasher.</i></p> <p><i>An additional infill panel must be ordered for planning dimensions over 650 mm.</i></p> <p><i>The hinged doors must open to an angle of at least 90° (observe handle spacing).</i></p>	UE	110	LMP	321	332	340	348	361	376	403	-	-	-	4	4
	<p>Corner base unit same as above, but 2 fully pivotable wooden carousel shelves with LeMans metal rail</p> <p><i>Planning dimension 1100 x 650 mm Carcase width 900 mm</i></p> <p><i>May be pulled forward to balance dimensions. (minimum dimension: 1100 x 600 mm)</i></p> <p><i>Minimum planning dimension 1100 mm must be observed.</i></p>	UE	110	LM	295	306	316	321	335	350	376	-	-	-	4	4

2.22 The anti-tilt device which is supplied automatically must be fitted for room divider versions.

Corner base units

723 mm high

Unit without worktop and plinth, carcass depth 560 mm

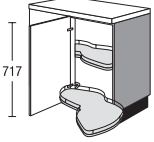
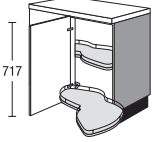
		width	Price group							Servosoft	Pro Servosoft	ProServoglass	Soft closing Top Motion	Soft closing Top Motion Plus		
			1	2	3	4	5	6	7							
 <p>Version L</p>	<p>Corner base unit</p> <p>with smooth built-in panel and loose infill panel 50 mm wide in door finish or door colour for adding on base units</p> <ul style="list-style-type: none"> 1 hinged door 2 fully pivotable wooden carousel shelves with LeMans metal rail with self-closing mechanism and cushioning effect <p><i>Planning dimension 1150 x 650 mm</i> <i>Not to fall below planning dimension 1150 mm. (carcase width 1000 mm)</i></p> <p><i>May be pulled forward to balance dimensions. (minimum dimensions: 1150 x 600 mm)</i></p> <p><i>When planning kitchens with a dishwasher next to the corner unit, the corner trim is supplied with return.</i></p> <p><i>An additional infill panel must be ordered for planning dimensions over 650 mm.</i></p> <p><i>The hinged doors must open to an angle of at least 90° (observe handle spacing).</i></p> <p><i>Order hinged door opening limited Z19 separately if required.</i></p>	UE	115	LMP	327	338	346	354	368	383	411	-	-	-	4	4
	<p>Corner base unit</p> <p>same as above, but</p> <ul style="list-style-type: none"> 2 fully pivotable wooden carousel shelves with LeMans metal rail 	UE	115	LM	301	312	322	328	342	357	384	-	-	-	4	4
 <p>Version L</p>	<p>Corner base unit</p> <p>with smooth built-in panel and loose infill panel 50 mm wide in door finish or door colour for adding on base units</p> <ul style="list-style-type: none"> 1 hinged door 2 fully pivotable wooden carousel shelves with LeMans metal rail with self-closing mechanism and cushioning effect <p><i>Planning dimension 1250 x 650 mm</i> <i>Not to fall below planning dimension 1250 mm. (carcase width 1000 mm)</i></p> <p><i>May be pulled forward to balance dimensions. (minimum dimensions: 1250 x 600 mm)</i></p> <p><i>When planning kitchens with a dishwasher next to the corner unit, the corner trim is supplied with return.</i></p> <p><i>An additional infill panel must be ordered for planning dimensions over 650 mm.</i></p> <p><i>The hinged doors must open to an angle of at least 90° (observe handle spacing).</i></p> <p><i>Order hinged door opening limited Z19 separately if required.</i></p>	UE	125	LMP	336	347	356	364	378	394	423	-	-	-	4	4
	<p>Corner base unit</p> <p>same as above, but</p> <ul style="list-style-type: none"> 2 fully pivotable wooden carousel shelves with LeMans metal rail 	UE	125	LM	310	321	330	338	352	368	396	-	-	-	4	4

The anti-tilt device which is supplied automatically must be fitted for room divider versions.

Corner base units

723 mm high

Unit without worktop and plinth, carcass depth 560 mm

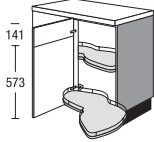
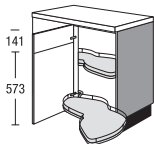
		width	Price group							Servosoft	Pro Servosoft	ProServoGlass	Soft closing Top Motion	Soft closing Top Motion Plus		
			1	2	3	4	5	6	7							
 <p>Version L</p>	<p>Corner base unit</p> <p>with smooth built-in panel and loose infill panel 50 mm wide in door finish or door colour for adding on base units</p> <p>1 door (dowelled)</p> <p>2 fully pivotable wooden carousel shelves with LeMans metal rail</p> <p>with self-closing mechanism and cushioning effect</p> <p><i>Planning dimension 1150 x 650 mm</i></p> <p><i>Not to fall below planning dimension 1150 mm. (carcase width 1000 mm)</i></p> <p><i>May be pulled forward to balance dimensions. (minimum dimensions: 1150 x 600 mm)</i></p> <p><i>When planning kitchens with a dishwasher next to the corner unit, the corner trim is supplied with return.</i></p> <p><i>An additional infill panel must be ordered for planning dimensions over 650 mm.</i></p> <p><i>The hinged doors must open to an angle of at least 90° (observe handle spacing).</i></p> <p><i>Order hinged door opening limited Z19 separately if required.</i></p>	UE	115	MSLMP	330	341	349	357	371	386	414	-	-	-	4	4
	 <p>Version L</p>	<p>Corner base unit</p> <p>with smooth built-in panel and loose infill panel 50 mm wide in door finish or door colour for adding on base units</p> <p>1 door (dowelled)</p> <p>2 fully pivotable wooden carousel shelves with LeMans metal rail</p> <p>with self-closing mechanism and cushioning effect</p> <p><i>Planning dimension 1250 x 650 mm</i></p> <p><i>Not to fall below planning dimension 1250 mm. (carcase width 1000 mm)</i></p> <p><i>May be pulled forward to balance dimensions. (minimum dimensions: 1250 x 600 mm)</i></p> <p><i>When planning kitchens with a dishwasher next to the corner unit, the corner trim is supplied with return.</i></p> <p><i>An additional infill panel must be ordered for planning dimensions over 650 mm.</i></p> <p><i>The hinged doors must open to an angle of at least 90° (observe handle spacing).</i></p> <p><i>Order hinged door opening limited Z19 separately if required.</i></p>	UE	125	MSLMP	334	345	353	361	376	391	420	-	-	-	4

2.24 The anti-tilt device which is supplied automatically must be fitted for room divider versions.

Corner base units

723 mm high

Unit without worktop and plinth, carcass depth 560 mm

		width	Price group							Servosoft	Pro Servosoft	ProServoglass	Soft closing Top Motion	Soft closing Top Motion Plus	
			1	2	3	4	5	6	7						
 <p>Corner base unit with smooth built-in panel and loose infill panel 50 mm wide in door finish or door colour for adding on base units 1 drawer 1 hinged door 2 fully pivotable wooden carousel shelves with LeMans metal rail with self-closing mechanism and cushioning effect</p> <p><i>Planning dimension 1100 x 650 mm Minimum planning dimension 1100 mm must be observed. Carcass width 900 mm</i></p> <p><i>May be pulled forward to balance dimensions. (minimum dimension: 1100 x 600 mm)</i></p> <p><i>The corner infill panel is supplied with returns for kitchens planned with adjacent dishwasher.</i></p> <p><i>An additional infill panel must be ordered for planning dimensions over 650 mm.</i></p> <p><i>The hinged doors must open to an angle of at least 90° (observe handle spacing).</i></p>	UES	110	LMP	337	348	356	364	378	393	421	5	8	8	4	4
	<p>with 45 cm door</p>														
<p>Corner base unit same as above, but 2 fully pivotable wooden carousel shelves with LeMans metal rail</p> <p><i>Planning dimension 1100 x 650 mm Minimum planning dimension 1100 mm must be observed. Carcass width 900 mm</i></p> <p><i>May be pulled forward to balance dimensions. (minimum dimension: 1100 x 600 mm)</i></p>	UES	110	LM	311	322	330	338	351	367	394	5	8	8	4	4
	<p>with 45 cm door</p>														

The anti-tilt device which is supplied automatically must be fitted for room divider versions.

Corner base units

723 mm high

Unit without worktop and plinth, carcass depth 560 mm

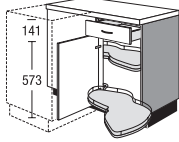
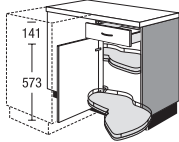

		width	Price group							Servosoft	Pro Servosoft	ProServoGlass	Soft closing Top Motion	Soft closing Top Motion Plus	
			1	2	3	4	5	6	7						
 <p>Version L</p> <p>Corner base unit with smooth built-in panel and loose infill panel 50 mm wide in door finish or door colour for adding on base units 1 drawer 1 hinged door 2 fully pivotable wooden carousel shelves with LeMans metal rail with self-closing mechanism and cushioning effect</p> <p><i>Planning dimension 1150 x 650 mm Not to fall below planning dimension 1150 mm. (carcase width 1000 mm)</i></p> <p><i>May be pulled forward to balance dimensions. (minimum dimensions: 1150 x 600 mm)</i></p> <p><i>When planning kitchens with a dishwasher next to the corner unit, the corner trim is supplied with return.</i></p> <p><i>An additional infill panel must be ordered for planning dimensions over 650 mm.</i></p> <p><i>The hinged doors must open to an angle of at least 90° (observe handle spacing).</i></p> <p><i>Order hinged door opening limited Z19 separately if required.</i></p>	UES	115	LMP	341	352	360	368	382	398	426	5	8	8	4	4
	<p>Corner base unit same as above, but 2 fully pivotable wooden carousel shelves with LeMans metal rail</p>	UES	115	LM	315	326	334	342	356	372	399	5	8	8	4
 <p>Version L</p> <p>Corner base unit with smooth built-in panel and loose infill panel 50 mm wide in door finish or door colour for adding on base units 1 drawer 1 hinged door 2 fully pivotable wooden carousel shelves with LeMans metal rail with self-closing mechanism and cushioning effect</p> <p><i>Planning dimension 1250 x 650 mm Not to fall below planning dimension 1250 mm. (carcase width 1000 mm)</i></p> <p><i>May be pulled forward to balance dimensions. (minimum dimensions: 1250 x 600 mm)</i></p> <p><i>When planning kitchens with a dishwasher next to the corner unit, the corner trim is supplied with return.</i></p> <p><i>An additional infill panel must be ordered for planning dimensions over 650 mm.</i></p> <p><i>The hinged doors must open to an angle of at least 90° (observe handle spacing).</i></p> <p><i>Order hinged door opening limited Z19 separately if required.</i></p>	UES	125	LMP	351	362	371	379	393	410	438	5	8	8	4	4
	<p>Corner base unit same as above, but 2 fully pivotable wooden carousel shelves with LeMans metal rail</p>	UES	125	LM	325	336	345	353	367	384	411	5	8	8	4

2.26 The anti-tilt device which is supplied automatically must be fitted for room divider versions.

Diagonal angled base units

723 mm high

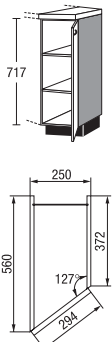
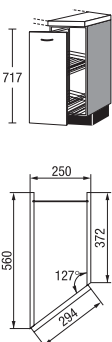
Unit without worktop and plinth, carcass depth 560 mm





		Price group																			
		width								Servosoft	Pro Servosoft	ProServoglass	Soft closing Top Motion	Soft closing Top Motion Plus							
			1	2	3	4	5	6	7												
 <p>3-D base unit 560/372 mm deep 1 hinged door 2 adjustable shelves</p> <p><i>Measurements with worktop 290 mm</i> <i>Measurements with modular panel 275 mm</i></p>	UV	25								93	97	101	105	112	119	129	-	-	-	4	4
	UVA	25								176	180	184	188	195	202	215	-	-	-	-	-
	UV	25	T							199	208	209	210	219	220	230	-	-	-	-	-
 <p>3-D base unit 560/372 mm deep 1 full-extension pull-out with cushioning 2 adjustable wire baskets</p> <p><i>Wire parts silver grey</i></p> <p><i>Handle only fitted horizontally</i></p> <p><i>Hinge R = track left</i> <i>Hinge L = track right</i></p> <p><i>Measurements with worktop 290 mm</i> <i>Measurements with modular panel 275 mm</i></p> <p><i>The delivery comprises several packages.</i></p> 	UV	25								199	208	209	210	219	220	230	-	-	-	-	-
	UVA	25								176	180	184	188	195	202	215	-	-	-	-	-
	UV	25	T							199	208	209	210	219	220	230	-	-	-	-	-

The anti-tilt device which is supplied automatically must be fitted for room divider versions.

Waste separator

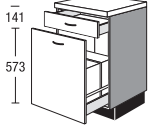
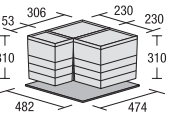
723 mm high

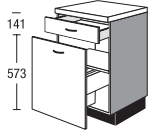
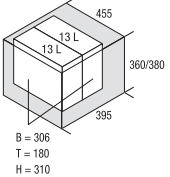
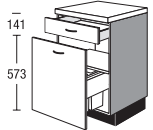
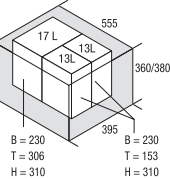
Unit without worktop and plinth, carcass depth 560 mm



	USA	width	M1	Price group							Servosoft	Pro Servosoft	ProServoGlass	Soft closing Top Motion	Soft closing Top Motion Plus
				1	2	3	4	5	6	7					
 <p>Base unit with waste separation system 1 drawer 1 deep drawer with waste separation system consisting of: 2 containers 17 litres each, each with lid 1 container 8 litres with lid 1 base panel</p>  		60	M1	119	132	139	146	170	183	202	10	16	24	-	-
 <p>Base unit with waste separation system 1 drawer 1 deep drawer</p> <p>1 cover panel 2 containers Capacity 50 cm wide: each 13 litres 60 cm wide: each 17 litres</p> <p><i>Pull-out depth including waste sorting system: 400 mm</i></p> 	USA	50	MH2	218	234	238	241	272	285	304	-	6	6	-	-
	USA	60	MH2	227	244	248	251	283	296	316	-	6	6	-	-
 <p>Base unit with waste separation system 1 drawer 1 deep drawer</p> <p>1 cover panel 3 waste bins Capacity 2 containers 8 litres with lid 1 container 17 litres</p> <p><i>Pull-out depth including waste sorting system: 400 mm</i></p>  	USA	60	MH3	238	256	260	264	297	311	331	-	6	6	-	-

2.28 The anti-tilt device which is supplied automatically must be fitted for room divider versions.

Waste separator

723 mm high

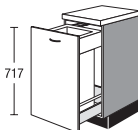
Unit without worktop and plinth, carcass depth 560 mm

		width	Price group							Servosoft	Pro Servosoft	ProServoglass	Soft closing Top Motion	Soft closing Top Motion Plus		
			1	2	3	4	5	6	7							
	Base unit for collecting recyclables 1 deep drawer 1 swing lid 1 recycling bin Capacity approx. 53 litres	UA	40	M	144	154	164	174	195	210	230	5	8	16	-	-
																

The anti-tilt device which is supplied automatically must be fitted for room divider versions.

2.29

Shelf units

723 mm high

Unit without worktop and plinth, carcass depth 560 mm

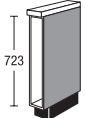
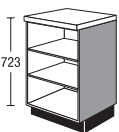
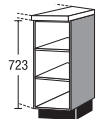
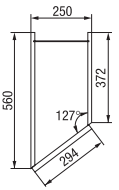
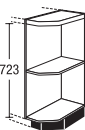
				width	Price group							Servosoft	Pro Servosoft	ProServoGlass	Soft closing Top Motion	Soft closing Top Motion Plus
					1	2	3	4	5	6	7					
	Base shelf unit Compartment 520 mm deep <i>Finish in carcass material</i> <i>Not available in visible side colours.</i>	☑	UR	15	67	67	67	67	67	67	67	-	-	-	-	-
		Base shelf unit 2 adjustable shelves <i>Finish in carcass material</i> <i>Please indicate desired width (150-600 mm).</i> <i>Not available in visible side colours.</i>	☑	UR	V	113	113	113	113	113	113	113	-	-	-	-
 	3-D open shelf base unit 560/372 mm deep 2 adjustable shelves <i>Finish in carcass material</i> <i>Measurements with worktop 290 mm</i> <i>Measurements with modular panel 275 mm</i> <i>Not available in visible side colours.</i>		UVR	25	89	89	89	89	89	89	89	-	-	-	-	-
		Shelf end unit, angled 1 fixed shelf <i>Finish in carcass material</i> <i>Measurements with worktop 290 mm</i> <i>Measurements with modular panel 275 mm</i> <i>Not available in visible side colours.</i>		URA	25	S	79	79	79	79	79	79	-	-	-	-

2.30 The anti-tilt device which is supplied automatically must be fitted for room divider versions.

Shelf units

723 mm high

Unit without worktop and plinth, carcass depth 560 mm

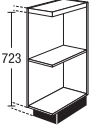
		width	Price group							Servosoft	Pro Servosoft	ProServoglass	Soft closing Top Motion	Soft closing Top Motion Plus	
			1	2	3	4	5	6	7						
	<p>Angled open end shelf Width 250 mm</p> <p>1 fixed shelf</p> <p>Measurements with worktop 290 mm Measurements with modular panel 275 mm</p> <p>Finish in carcass material</p> <p>Available in all carcass finishes.</p> <p>Not available in visible side colours.</p>	URA	25	59	59	59	59	59	59	59	-	-	-	-	-
	<p>Angled open end shelf Width 300 mm</p> <p>same as above, but</p> <p>Planning dimension with panel 340 mm Planning dimension with modular panel 325 mm</p> <p>Available in all carcass finishes.</p> <p>Additional colour variants: 112 Cappuccino 121 Thyme 133 Volcano brown 134 Alby Blue 158 Sage green 952 Petrol</p> <p>Not available in visible side colours.</p>	URA	30	89	89	89	89	89	89	89	89	-	-	-	-

The anti-tilt device which is supplied automatically must be fitted for room divider versions.

2.31

Shelf units

723 mm high

Unit without worktop and plinth, Carcase depth 326 mm

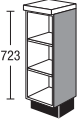
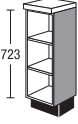
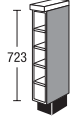
		UR	width		Price group							Servosoft	Pro Servosoft	ProServoGlass	Soft closing Top Motion	Soft closing Top Motion Plus
					1	2	3	4	5	6	7					
 <p>Base shelf unit 2 adjustable shelves <i>Finish in carcass material</i> <i>When used at end of unit row, also order side panel or ST3 / ST31.</i> <i>Not available in visible side colours.</i></p>		UR	30	33	68	68	68	68	68	68	68	-	-	-	-	-
 <p>Base shelf unit 2 adjustable shelves Please indicate desired width (150-600 mm). <i>Finish in carcass material</i> <i>When used at end of unit row, also order side panel or ST3 / ST31.</i> <i>Not available in visible side colours.</i></p>	<input checked="" type="checkbox"/>	UR	V	33	79	79	79	79	79	79	79	-	-	-	-	-
 <p>Open shelf unit for bottles 5 compartments for bottles 4 fixed shelves <i>Finish in carcass material</i> <i>When used at end of unit row, also order side panel or ST3 / ST31.</i> <i>Not available in visible side colours.</i></p>		UR	15	33F	69	69	69	69	69	69	69	-	-	-	-	-

2.32 The anti-tilt device which is supplied automatically must be fitted for room divider versions.

Filler panels

723 mm high

Unit without worktop and plinth.

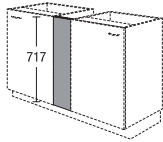
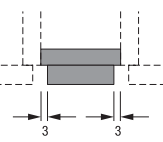
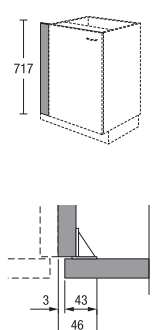
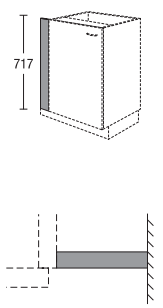
			width	Price group							Servosoft	Pro Servosoft	ProServoglass	Soft closing Top Motion	Soft closing Top Motion Plus
				1	2	3	4	5	6	7					
 <p>Infill panel for base units without plinth, 723 mm high Fitted between base units</p> <p><i>Finish in door material with straight edge on both sides</i></p> <p><i>Some front edges in colour of carcass.</i></p> <p><i>Not available in visible side colours.</i></p>	UPF	10	Z	14	17	18	19	20	21	23	-	-	-	-	-
	UPF	20	Z	17	19	20	21	22	24	28	-	-	-	-	-
 <p>Infill panel for base units without plinth, 723 mm high Fitted between wall and carcass side</p> <p><i>Finish in door material without edging on the wall side</i></p> <p><i>Some front edges in colour of carcass.</i></p> <p><i>Not available in visible side colours.</i></p> <p><i>Due to the installation angle, the maximum possible on-site width reduction is 46 mm.</i></p>	UPF	10		14	17	18	19	20	21	23	-	-	-	-	-
	UPF	20		18	21	22	23	25	27	30	-	-	-	-	-
 <p>Infill panel for base units same as above, but with carcass returns when planned next to a dishwasher.</p> <p>without plinth, 723 mm high Fitted between wall and carcass side</p>	UPF	10	GS	20	24	26	27	29	30	33	-	-	-	-	-
	UPF	20	GS	24	28	29	31	33	36	39	-	-	-	-	-
 <p>Infill panel for base units without plinth, 723 mm high</p> <p><i>Finish in carcass material</i></p> <p><i>Not available in visible side colours.</i></p>	UPK	10		10	10	10	10	10	10	10	-	-	-	-	-
	UPK	20		13	13	13	13	13	13	13	-	-	-	-	-
	UPK	30		16	16	16	16	16	16	16	-	-	-	-	-

The anti-tilt device which is supplied automatically must be fitted for room divider versions.

Filler panels

723 mm high

Unit without worktop and plinth.

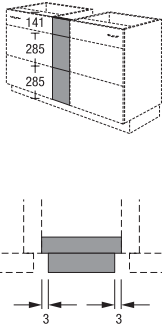
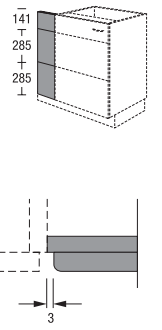
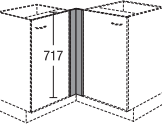
		width		Price group							Servosoft	Pro Servosoft	ProServoGlass	Soft closing Top Motion	Soft closing Top Motion Plus
				1	2	3	4	5	6	7					
 <p>Infill panel for base units without plinth, 723 mm high Fitted between base units</p> <p><i>Finish in door material sides with straight edges</i></p> <p><i>Some front edges in colour of carcass.</i></p> <p><i>Not available in visible side colours.</i></p> <p><i>Not available for ranges IP 4250, IP 4820, IP 7500, IP 7810 CK, IP 7820 CK.</i></p>	UPF	20	M3Z	29	32	34	36	38	41	46	-	-	-	-	-
	UPF	20	M3	29	34	35	37	40	44	47	-	-	-	-	-
 <p>Infill panel for base units without plinth, 723 mm high Fitted between wall and carcass side</p> <p><i>Finish in door material without edging on the wall side</i></p> <p><i>Some front edges in colour of carcass.</i></p> <p><i>Not available in visible side colours.</i></p> <p><i>Not available for ranges IP 4250, IP 4820, IP 7500, IP 7810 CK, IP 7820 CK.</i></p>	UPF	20	GSM3	39	46	47	50	54	59	64	-	-	-	-	-
	UPF	20	GSM3	39	46	47	50	54	59	64	-	-	-	-	-
 <p>Corner infill panel for base units without plinth, 723 mm high</p> <p><i>Finish in carcass material for corner 600 x 600 mm</i></p> <p><i>With adjoining units with drawers/pull- outs, check the clearance for opening. Not available in visible side colours.</i></p>	UPEK	60		12	12	12	12	12	12	12	-	-	-	-	-
	UPEF	65		21	24	25	26	27	29	33	-	-	-	-	-
	UPEF	65	GS	23	26	27	28	29	31	35	-	-	-	-	-

2.34 The anti-tilt device which is supplied automatically must be fitted for room divider versions.

Filler panels

723 mm high

Unit without worktop and plinth.

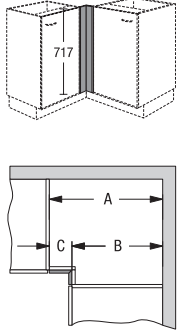
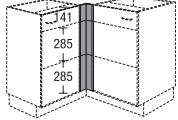
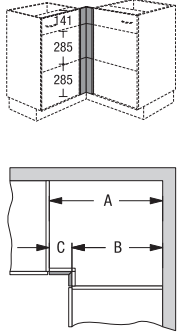
		width	Price group							Servosoft	Pro Servosoft	ProServoglass	Soft closing Top Motion	Soft closing Top Motion Plus	
			1	2	3	4	5	6	7						
 <p>Corner infill panel for base units without plinth, 723 mm high <i>Finish in door material</i> <i>Dimensions given are from one carcass corner to another</i> <i>Side dimensions of less than 60 mm width are manufactured from carcass material</i> <i>Not available in visible side colours.</i></p> <p>Panel size in mm: A-B=C</p>	<p>Corner infill panel for base units without plinth, 723 mm high <i>Finish in door material</i> <i>Dimensions given are from one carcass corner to another</i> <i>Side dimensions of less than 60 mm width are manufactured from carcass material</i> <i>Not available in visible side colours.</i></p>	UPEF 76 Leg width 40-191 mm	V	26	30	31	33	36	39	43	-	-	-	-	-
	<p>Corner infill panel for base units same as above, but with carcass returns when planned next to a dishwasher.</p>	UPEF 76 Leg width 40-191 mm	VGS	28	32	33	35	38	41	45	-	-	-	-	-
 <p>Corner infill panel for base units without plinth, 723 mm high <i>Finish in door material for corner 650 x 650 mm</i> <i>Not available in visible side colours.</i> <i>Not available for ranges IP 4250, IP 4820, IP 7500, IP 7810 CK, IP 7820 CK.</i></p>	<p>Corner infill panel for base units without plinth, 723 mm high <i>Finish in door material for corner 650 x 650 mm</i> <i>Not available in visible side colours.</i> <i>Not available for ranges IP 4250, IP 4820, IP 7500, IP 7810 CK, IP 7820 CK.</i></p>	UPEF 65	M3	38	44	46	48	50	54	65	-	-	-	-	-
	<p>Corner infill panel for base units same as above, but with carcass returns when planned next to a dishwasher.</p>	UPEF 65	M3GS	50	55	57	59	61	65	75	-	-	-	-	-
 <p>Corner infill panel for base units without plinth, 723 mm high <i>Finish in door material</i> <i>Dimensions given are from one carcass corner to another</i> <i>Side dimensions of less than 60 mm width are manufactured from carcass material</i> <i>Not available in visible side colours.</i> <i>Not available for ranges IP 4250, IP 4820, IP 7500, IP 7810 CK, IP 7820 CK.</i></p> <p>Panel size in mm: A-B=C</p>	<p>Corner infill panel for base units without plinth, 723 mm high <i>Finish in door material</i> <i>Dimensions given are from one carcass corner to another</i> <i>Side dimensions of less than 60 mm width are manufactured from carcass material</i> <i>Not available in visible side colours.</i> <i>Not available for ranges IP 4250, IP 4820, IP 7500, IP 7810 CK, IP 7820 CK.</i></p>	UPEF 76 Leg width 40-191 mm	VM3	47	54	56	60	65	71	77	-	-	-	-	-
	<p>Corner infill panel for base units same as above, but with carcass returns when planned next to a dishwasher.</p>	UPEF 76 Leg width 40-191 mm	VM3GS	58	67	69	74	80	87	95	-	-	-	-	-

The anti-tilt device which is supplied automatically must be fitted for room divider versions.

Filler panels

723 mm high

Unit without worktop and plinth.

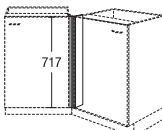
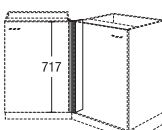
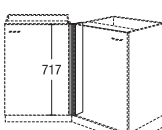
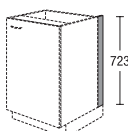
	width	Price group							Servosoft	Pro Servosoft	ProServoGlass	Soft closing Top Motion	Soft closing Top Motion Plus
		1	2	3	4	5	6	7					
 <p>Corner infill panel for 135° base unit corner installations without plinth, 723 mm high <i>can be used on both sides</i> <i>Finish in carcass colour</i> <i>Not available in visible side colours.</i></p> <p>UPEK 135 2: For 600 mm units with planning dimension 1050 x 1050 mm For use in pairs beside a 600 mm base unit.</p> <p>UPEK 135: For 135° configurations (free-standing)</p> <p>UPEK 90 2: For 400 mm units with planning dimension 900 x 900 mm For use in pairs beside a 400 mm base unit.</p>	UPEK135	2	11	11	11	11	11	11	11	-	-	-	-
	UPEK135		11	11	11	11	11	11	11	-	-	-	-
	UPEK 90	2	11	11	11	11	11	11	11	-	-	-	-
 <p>Corner infill panel for 135° base unit corner installations without plinth, 723 mm high <i>can be used on both sides</i> <i>Finish in door material</i> <i>Not available in visible side colours.</i></p>	UPEF135		27	31	32	33	35	37	42	-	-	-	-
	UPEF	V	28	34	36	38	40	42	46	-	-	-	-
 <p>Corner filler strip for adjusting on site Set consists of 2 single panels per 100 mm width without plinth, 723 mm high <i>Finish in door material</i> <i>Not available in visible side colours.</i> <i>Not available for Color Concept ranges.</i></p>	UPT	10	11	11	11	11	11	11	11	-	-	-	-
	UPT	20	13	13	13	13	13	13	13	-	-	-	-
	UPT	30	15	15	15	15	15	15	15	-	-	-	-
 <p>Infill panel base-unit side without plinth, 723 mm high for wall end <i>Finish in carcass material</i> <i>for deeper tops, order plinth SO 151 separately</i> <i>Not available in visible side colours.</i></p>	UPT	10	11	11	11	11	11	11	11	-	-	-	-
	UPT	20	13	13	13	13	13	13	13	-	-	-	-
	UPT	30	15	15	15	15	15	15	15	-	-	-	-

2.36 The anti-tilt device which is supplied automatically must be fitted for room divider versions.

Filler panels

723 mm high

Unit without worktop and plinth.

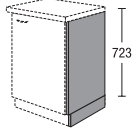

Side support panel

including plinth
To cover end shelf units or electrical appliances without plinth, 723 mm high

Finish in carcass material

The worktop has to be extended by 20 mm when using side support ST3 / ST 31.

Not available in visible side colours.

ST3
560 mm deep
ST31
860 mm deep

width

Price group

1 2 3 4 5 6 7

Servosoft
Pro Servosoft
ProServoglass
Soft closing Top Motion
Soft closing Top Motion Plus

19	19	19	19	19	19	19
26	26	26	26	26	26	26

-	-	-	-	-	-	-
-	-	-	-	-	-	-

The anti-tilt device which is supplied automatically must be fitted for room divider versions.

Notes

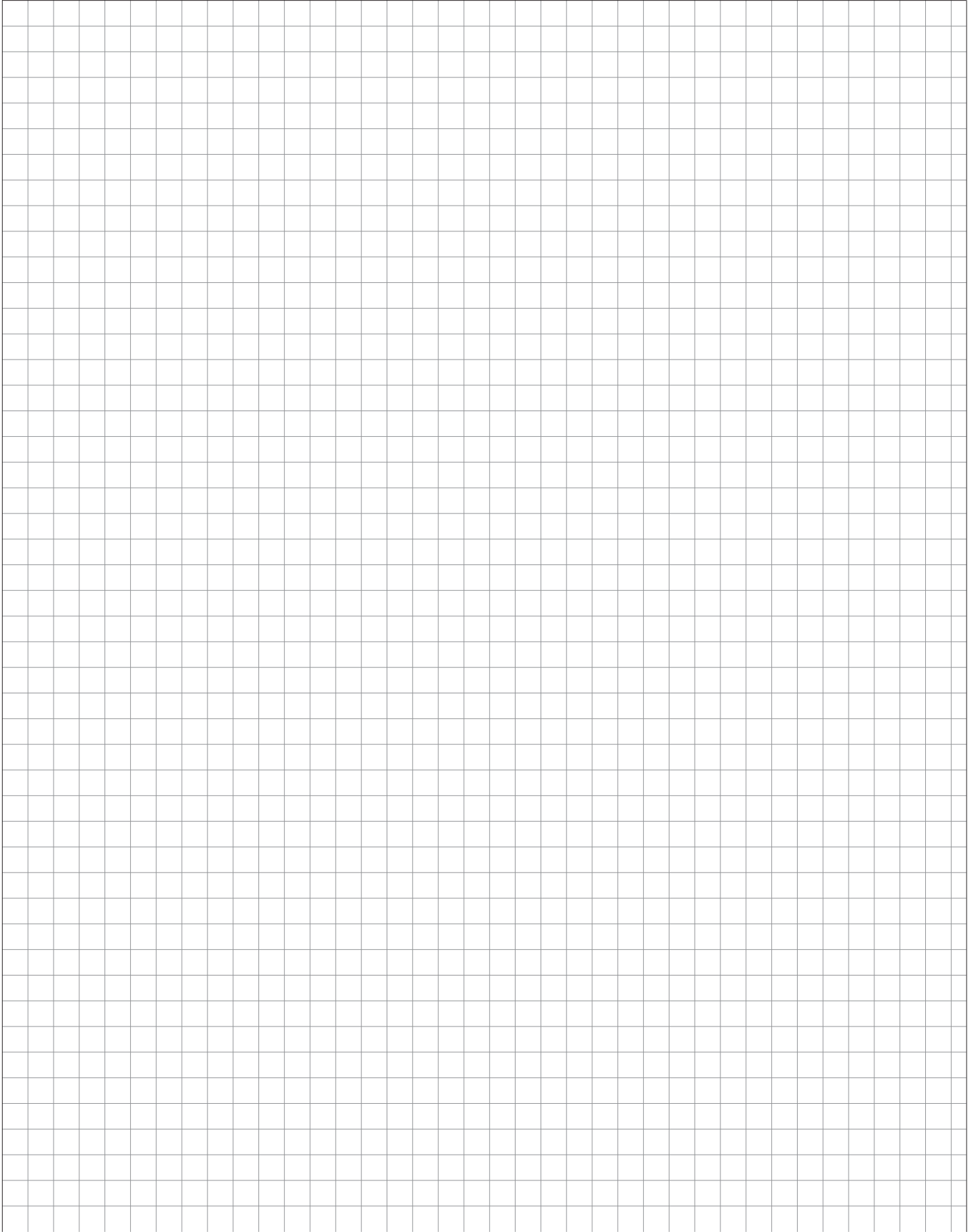

Hob housings / sink base units

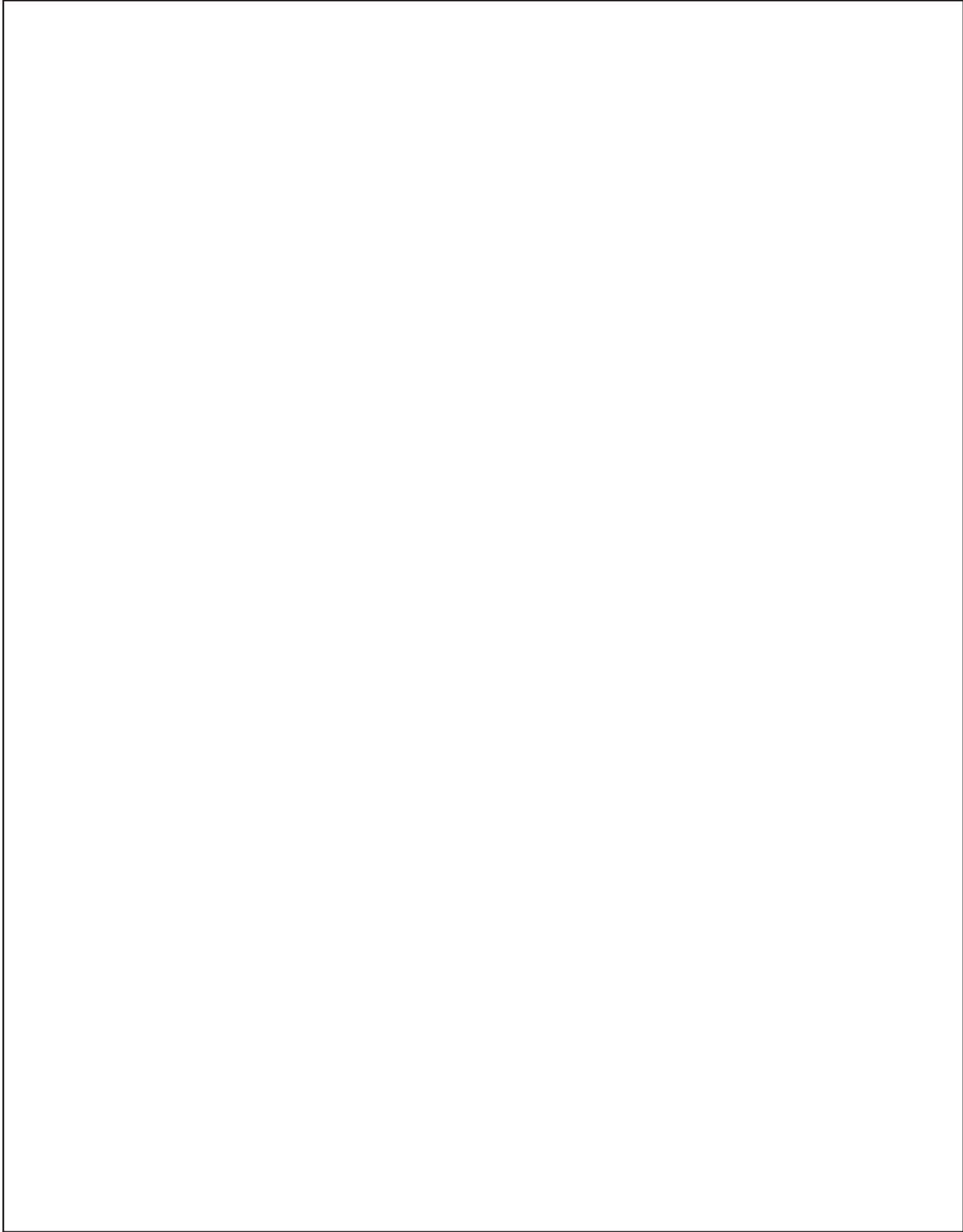

Hob housings / sink base
units

Hob housings / sink base units

Planning information for hob base units

For safety reasons, it is essential to fit a heat shield for conventional hobs and induction hobs if the appliance in question does not have its own heat shield and is to be fitted in a worktop directly above a drawer, deep drawer or side-hung door.

Batches in range C will also have a cut-out in the handle profile. This will be cut at the factory. Therefore, please specify the appliance type when ordering. Item type CLHFIK must be included in the order.

If planning hobs over a number of cabinets, the neighbouring cabinets must also be fitted with heat shields.

Induction hobs must not be planned over 2-door base units or corner cabinets as it is not possible to adapt the heat shield to these items.

Check the feasibility before using ceramic hobs with heat radiation across semi-corner cabinets.

For safety reasons, hobs may not be fitted over built-under appliances without a heat shield.

Oven housing units / hob units

723 mm high

Unit without worktop and plinth, carcass depth 560 mm

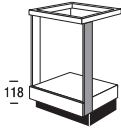
		width	Price group							Servosoft	Pro Servosoft	ProServoglass	Soft closing Top Motion	Soft closing Top Motion Plus
			1	2	3	4	5	6	7					
<p>Information for plans with standalone hobs</p> <p>For orders that contain a hob we are obliged, for product liability reasons, to confirm and deliver a hob base unit with the appropriate heat resistant panel. Cancellation/amendment is not possible.</p> <p>For appliances from a third-party (hob not provided by us), we urgently require written confirmation that a unit with a heat resistant panel is not desired or required.</p> <p>You will find the appliance heights of the hobs in our range in the Sales manual appliances under the respective item.</p> <p>Depending on the particular appliance (installation height) and worktop depth, a drawer with a low frame may be provided.</p>														
	<p>Cooker power supply cable</p> <p>5 x 2.5 mm² 2000 mm long</p>	ZH 200	4	4	4	4	4	4	4	-	-	-	-	-
	<p>Base unit for built-under oven</p> <p>niche sizes: 599 mm high, max. 568 mm wide, 560 mm deep</p> <p>1 fixed front panel and loose side carcass profiles</p> <p><i>Oven model must be indicated</i></p> <p><i>Please state worktop thickness</i></p> <p><i>Only for use between two base units. To finish the end of a line, order ST 3 or base-unit end panel, or plan UHK / UHS.</i></p> <p><i>For foil-wrapped fronts a set of heat deflector plates are supplied free of charge.</i></p> <p><i>Unit will be delivered flat packed.</i></p> <p><i>During planning and installation, it is essential to observe the safety distances of the electrical appliance manufacturer!</i></p>	UHB	28	31	33	35	37	40	45	-	-	-	-	-

The anti-tilt device which is supplied automatically must be fitted for room divider versions.

2.39

Oven housing units / hob units

723 mm high

Unit without worktop and plinth, carcass depth 560 mm

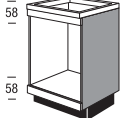
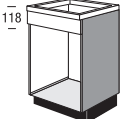
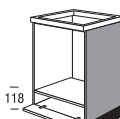
		width	Price group							Servosoft	Pro Servosoft	ProServoGlass	Soft closing Top Motion	Soft closing Top Motion Plus	
			1	2	3	4	5	6	7						
 <p>Base unit for built-under oven</p> <p>niche sizes: 599 mm high, max. 568 mm wide, 560 mm deep</p> <p>2 fixed front panels</p> <p><i>Oven model must be indicated</i></p> <p><i>Please state worktop thickness</i></p> <p><i>For foil-wrapped fronts a set of heat deflector plates are supplied free of charge.</i></p> <p><i>During planning and installation, it is essential to observe the safety distances of the electrical appliance manufacturer!</i></p> <p><i>Available for the following ranges: IP 1200, IP 2200, IP 3150, IP 4050</i></p>	UHB2				80	83	86	89	93	96	102	-	-	-	-
 <p>Base unit for built-under oven</p> <p>niche sizes: 599 mm high, max. 568 mm wide, 560 mm deep</p> <p>1 fixed front panel 1 metal plinth base</p> <p><i>Oven model must be indicated</i></p> <p><i>For foil-wrapped fronts a set of heat deflector plates are supplied free of charge.</i></p> <p><i>During planning and installation, it is essential to observe the safety distances of the electrical appliance manufacturer!</i></p>	UHB	60	1		76	79	82	85	88	91	97	-	-	-	-
 <p>Base unit for built-under oven</p> <p>niche sizes: 599 mm high, max. 568 mm wide, 560 mm deep</p> <p>with hinged front panel, with a space at the rear to store baking sheets</p> <p><i>Oven model must be indicated</i></p> <p><i>Please state worktop thickness</i></p> <p><i>For foil-wrapped fronts a set of heat deflector plates are supplied free of charge.</i></p> <p><i>During planning and installation, it is essential to observe the safety distances of the electrical appliance manufacturer!</i></p> <p><i>Cannot be combined with handle no. 783.</i></p>	UHK				67	70	73	76	79	82	88	-	-	-	4 4

2.40 The anti-tilt device which is supplied automatically must be fitted for room divider versions.

Oven housing units / hob units

723 mm high

Unit without worktop and plinth, carcass depth 560 mm

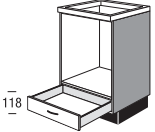
		width	Price group							Servosoft	Pro Servosoft	ProServoglass	Soft closing Top Motion	Soft closing Top Motion Plus	
			1	2	3	4	5	6	7						
	<p>Base unit for built-under oven</p> <p>niche sizes: 599 mm high, max. 568 mm wide, 560 mm deep</p> <p>1 drawer</p> <p><i>Oven model must be indicated</i></p> <p><i>Please state worktop thickness</i></p> <p><i>For foil-wrapped fronts a set of heat deflector plates are supplied free of charge.</i></p> <p><i>During planning and installation, it is essential to observe the safety distances of the electrical appliance manufacturer!</i></p>	UHS		76	79	82	85	88	91	97	5	8	8	-	-
	<p>Base unit for built-under oven</p> <p>Aperture dimensions: 432-486 mm high max. 868 mm wide, 560 mm deep</p> <p>1 fixed front panel 1 drawer</p> <p><i>Specify appliance type</i></p> <p><i>Front panel must be cut to size on-site.</i></p> <p><i>Not available for the following ranges: IP 4820, IP 7500</i></p> <p><i>Cannot be combined with handles No. 760 and No. 800.</i></p> <p><i>During planning and installation, it is essential to observe the safety distances of the electrical appliance manufacturer!</i></p>	UMBS	90	141	150	157	165	179	184	195	5	8	8	-	-
	<p>Base unit for built-under oven</p> <p>niche sizes: 599 mm high, max. 868 mm wide, 560 mm deep</p> <p>1 drawer</p> <p><i>Oven model must be indicated</i></p> <p><i>Please state worktop thickness</i></p> <p><i>For foil-wrapped fronts a set of heat deflector plates are supplied free of charge.</i></p> <p><i>Available for the following ranges: IP 1200, IP 2200, IP 3150, IP 4050</i></p> <p><i>During planning and installation, it is essential to observe the safety distances of the electrical appliance manufacturer!</i></p>	UHS	90	140	145	150	155	160	165	175	5	8	8	-	-

The anti-tilt device which is supplied automatically must be fitted for room divider versions.

2.41

Oven housing units / hob units

723 mm high

Unit without worktop and plinth, carcass depth 560 mm

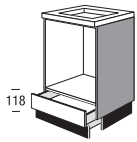
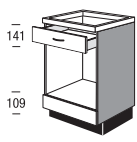
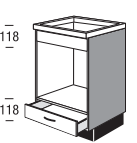
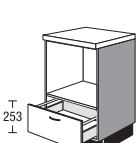
	width	Price group							Servosoft	Pro Servosoft	ProServoGlass	Soft closing Top Motion	Soft closing Top Motion Plus	
		1	2	3	4	5	6	7						
 <p>Base unit for built-under oven niche sizes: 599 mm high, max. 568 mm wide, 560 mm deep</p> <p>1 plinth container</p> <p><i>Oven model must be indicated</i></p> <p><i>Please state worktop thickness</i></p> <p><i>For foil-wrapped fronts a set of heat deflector plates are supplied free of charge.</i></p> <p><i>Only install at end of unit row in conjunction with modular panel or modular support panel.</i></p> <p><i>During planning and installation, it is essential to observe the safety distances of the electrical appliance manufacturer!</i></p>	UH	SW	98	103	105	107	110	113	122	5	5	5	-	-
 <p>Base unit for microwave oven Niche sizes: 450 mm high, max. 568 mm wide, 560 mm deep</p> <p>1 drawer 1 protective shelf 1 fixed front panel</p> <p><i>Specify appliance type</i></p> <p><i>Please state worktop thickness</i></p> <p><i>Available for the following ranges: IP 1200, IP 2200, IP 3150, IP 4050</i></p> <p><i>During planning and installation, it is essential to observe the safety distances of the electrical appliance manufacturer!</i></p>	KIMSB		138	147	154	162	175	180	191	5	8	8	-	-
 <p>Base unit for microwave oven Niche sizes: 450 mm high, max. 568 mm wide, 560 mm deep</p> <p>1 fixed front panel 1 drawer</p> <p><i>Specify appliance type</i></p> <p><i>Please state worktop thickness</i></p> <p><i>During planning and installation, it is essential to observe the safety distances of the electrical appliance manufacturer!</i></p>	UMBS		104	111	116	122	132	136	144	5	8	8	-	-
 <p>Base unit for microwave oven Niche sizes: 448 mm high, max. 568 mm wide, 560 mm deep</p> <p>1 deep drawer</p> <p><i>Specify appliance type</i></p> <p><i>During planning and installation, it is essential to observe the safety distances of the electrical appliance manufacturer!</i></p>	UMA		92	99	104	110	120	124	131	5	8	16	-	-

2.42 The anti-tilt device which is supplied automatically must be fitted for room divider versions.

Hob base units optimised for induction and conventionally heated hobs

723 mm high

Unit without worktop and plinth, carcass depth 560 mm

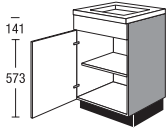
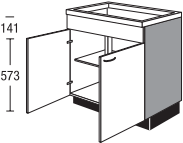
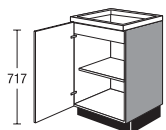
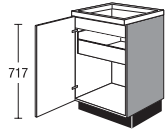
				Price group											
		width		1	2	3	4	5	6	7	Servosoft	Pro Servosoft	ProServoglass	Soft closing Top Motion	Soft closing Top Motion Plus
 <p>Hob base unit 1 fixed front panel 1 cable protection shelf 1 hinged door 1 adjustable shelf</p> <p><i>Please state worktop thickness</i></p> <p><i>Specify appliance type</i></p> <p><i>During planning and installation, it is essential to observe the safety distances of the electrical appliance manufacturer!</i></p>	KIB	30		61	66	72	77	90	96	104	-	-	-	4	4
	KIB	40		64	70	75	81	95	101	109	-	-	-	4	4
	KIB	45		65	71	76	82	86	103	111	-	-	-	4	4
	KIB	50		67	73	79	84	99	106	115	-	-	-	4	4
	KIB	60		69	75	81	87	102	109	118	-	-	-	4	4
 <p>Hob base unit 1 fixed front panel 1 cable protection shelf 2 hinged doors 1 adjustable shelf</p> <p><i>Please state worktop thickness</i></p> <p><i>Specify appliance type</i></p> <p><i>During planning and installation, it is essential to observe the safety distances of the electrical appliance manufacturer!</i></p>	KIB	80	3	92	100	107	115	135	146	161	-	-	-	8	8
	KIB	90	3	93	101	108	116	136	148	163	-	-	-	8	8
	KIB	100	3	99	107	114	122	142	154	169	-	-	-	8	8
 <p>Hob base unit 1 hinged door 1 fixed inside panel 1 cable protection shelf 1 adjustable shelf</p> <p><i>Please state worktop thickness</i></p> <p><i>Specify appliance type</i></p> <p><i>During planning and installation, it is essential to observe the safety distances of the electrical appliance manufacturer!</i></p>	KI	40		61	64	69	75	87	92	99	-	-	-	4	4
	KI	45		62	65	71	77	89	94	101	-	-	-	4	4
	KI	50		63	69	74	79	91	96	103	-	-	-	4	4
	KI	60		69	75	81	87	102	109	118	-	-	-	4	4
 <p>Hob base unit 1 hinged door 1 fixed inside panel 1 cable protection shelf 1 internal drawer</p> <p><i>Please state worktop thickness</i></p> <p><i>Specify appliance type</i></p> <p><i>The hinged doors must open to an angle of at least 90° (observe handle spacing).</i></p> <p><i>During planning and installation, it is essential to observe the safety distances of the electrical appliance manufacturer!</i></p>	KI	45	IS	87	93	98	103	115	121	130	5	8	8	4	4
	KI	50	IS	90	97	102	108	119	126	136	5	8	8	4	4
	KI	60	IS	96	103	109	115	128	137	149	5	8	8	4	4

The anti-tilt device which is supplied automatically must be fitted for room divider versions.

2.43

Hob base units optimised for induction and conventionally heated hobs

723 mm high

Unit without worktop and plinth, carcass depth 560 mm

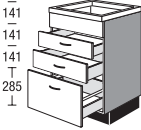
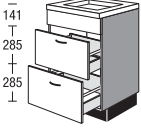
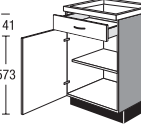
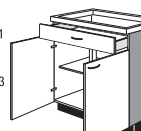
		width	Price group							Servosoft	Pro Servosoft	ProServoGlass	Soft closing Top Motion	Soft closing Top Motion Plus	
			1	2	3	4	5	6	7						
 <p>Hob base unit 1 fixed front panel 1 cable protection shelf 2 drawers 1 deep drawer</p> <p><i>Please state worktop thickness</i></p> <p><i>Specify appliance type</i></p> <p><i>During planning and installation, it is essential to observe the safety distances of the electrical appliance manufacturer!</i></p>	KIB2SA	45		109	116	123	131	145	156	171	15	24	32	-	-
	KIB2SA	50		110	119	126	134	150	160	174	15	24	32	-	-
	KIB2SA	60		112	124	130	137	158	170	187	15	24	32	-	-
	KIB2SA	80		166	177	186	195	219	235	256	18	27	35	-	-
	KIB2SA	90		168	179	188	197	221	237	258	18	27	35	-	-
	KIB2SA	100		182	195	205	215	243	260	284	18	27	35	-	-
	KIB2SA	120		214	229	241	253	286	306	334	21	30	46	-	-
 <p>Hob base unit 1 fixed front panel 1 cable protection shelf 2 deep drawers</p> <p><i>Please state worktop thickness</i></p> <p><i>Specify appliance type</i></p> <p><i>During planning and installation, it is essential to observe the safety distances of the electrical appliance manufacturer!</i></p>	KIB2A	45		101	108	115	123	137	148	163	10	16	32	-	-
	KIB2A	50		102	111	118	126	142	152	166	10	16	32	-	-
	KIB2A	60		104	116	122	129	150	162	178	10	16	32	-	-
	KIB2A	80		158	169	178	187	211	227	248	16	22	38	-	-
	KIB2A	90		160	171	180	189	213	229	250	16	22	38	-	-
	KIB2A	100		174	186	196	206	232	249	272	16	22	38	-	-
	KIB2A	120		206	220	232	244	275	295	322	16	22	38	-	-
 <p>Hob base unit 1 drawer 1 heat shield 1 hinged door 1 adjustable shelf</p> <p><i>Please state worktop thickness</i></p> <p><i>25 mm clearance to bottom edge of worktop.</i></p> <p><i>Specify appliance type</i></p> <p><i>During planning and installation, it is essential to observe the safety distances of the electrical appliance manufacturer!</i></p>	KIS	40		90	95	100	105	117	124	135	5	8	8	4	4
	KIS	45		91	97	102	107	120	127	137	5	8	8	4	4
	KIS	50		94	100	105	110	122	128	138	5	8	8	4	4
	KIS	60		101	107	113	119	135	140	150	5	8	8	4	4
 <p>Hob base unit 1 drawer 1 heat shield 2 hinged doors 1 adjustable shelf</p> <p><i>Please state worktop thickness</i></p> <p><i>25 or 40 mm clearance to bottom edge of worktop.</i></p> <p><i>Specify appliance type</i></p> <p><i>During planning and installation, it is essential to observe the safety distances of the electrical appliance manufacturer!</i></p>	KIS	80	3	126	135	144	153	177	192	212	5	8	8	8	8
	KIS	90	3	128	137	146	155	179	194	215	5	8	8	8	8
	KIS	100	3	134	142	151	161	186	201	222	5	8	8	8	8

2.44 The anti-tilt device which is supplied automatically must be fitted for room divider versions.

Hob base units optimised for induction and conventionally heated hobs

723 mm high

Unit without worktop and plinth, carcass depth 560 mm

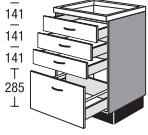
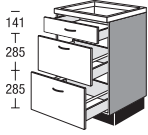
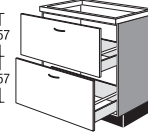
		width	Price group							Servosoft	Pro Servosoft	ProServodiamond	Soft closing Top Motion	Soft closing Top Motion Plus
			1	2	3	4	5	6	7					
 <p>Hob base unit</p> <ul style="list-style-type: none"> 1 drawer 1 heat shield 2 drawers 1 deep drawer <p>Please state worktop thickness</p> <p>25 or 40 mm clearance to bottom edge of worktop.</p> <p>Specify appliance type</p> <p>During planning and installation, it is essential to observe the safety distances of the electrical appliance manufacturer!</p>	K13SA	60	153	166	177	188	216	228	246	20	32	40	-	-
	K13SA	80	198	211	222	233	261	280	305	23	35	43	-	-
	K13SA	90	209	223	234	245	275	295	321	23	35	43	-	-
	K13SA	100	223	239	251	263	298	319	348	23	35	43	-	-
 <p>Hob base unit</p> <ul style="list-style-type: none"> 1 drawer 1 heat shield 2 deep drawers <p>Please state worktop thickness</p> <p>25 or 40 mm clearance to bottom edge of worktop.</p> <p>Specify appliance type</p> <p>During planning and installation, it is essential to observe the safety distances of the electrical appliance manufacturer!</p>	KIS2A	30	119	129	135	141	159	169	185	15	24	40	-	-
	KIS2A	40	127	138	144	150	169	180	197	15	24	40	-	-
	KIS2A	45	131	142	148	155	175	186	203	15	24	40	-	-
	KIS2A	50	135	147	153	159	180	192	209	15	24	40	-	-
	KIS2A	60	143	155	161	168	190	202	220	15	24	40	-	-
	KIS2A	80	182	193	202	211	235	251	273	21	30	46	-	-
	KIS2A	90	187	198	207	216	241	257	279	21	30	46	-	-
	KIS2A	100	199	210	219	228	253	269	292	21	30	46	-	-
KIS2A	120	231	244	254	265	294	312	339	21	30	38	-	-	
 <p>Hob base unit</p> <ul style="list-style-type: none"> 1 deep drawer 1 heat shield 1 deep drawer <p>Please state worktop thickness</p> <p>25 or 40 mm clearance to bottom edge of worktop.</p> <p>Specify appliance type</p> <p>During planning and installation, it is essential to observe the safety distances of the electrical appliance manufacturer!</p>	KI2A	60	148	159	168	177	201	217	238	10	16	32	-	-
	KI2A	80	181	191	200	209	231	247	268	16	22	38	-	-
	KI2A	90	190	201	210	219	243	259	281	16	22	38	-	-
	KI2A	100	206	217	227	236	261	277	301	16	22	38	-	-
	KI2A	120	226	238	249	259	286	304	330	16	22	38	-	-

The anti-tilt device which is supplied automatically must be fitted for room divider versions.

2.45

Hob base units optimised for induction and conventionally heated hobs

723 mm high

Unit without worktop and plinth, carcass depth 560 mm

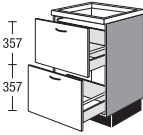
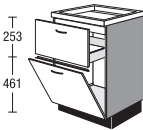
		width		Price group							Servosoft	Pro Servosoft	ProServoGlass	Soft closing Top Motion	Soft closing Top Motion Plus
				1	2	3	4	5	6	7					
 <p>Hob base unit 1 deep drawer 1 heat shield 1 internal drawer 1 deep drawer</p> <p><i>Please state worktop thickness</i></p> <p><i>25 mm clearance to bottom edge of worktop.</i> <i>Specify appliance type</i></p> <p><i>During planning and installation, it is essential to observe the safety distances of the electrical appliance manufacturer!</i></p> <p>Suitable additions:</p> <p>Carrier for interior drawer / interior deep drawer for screwing on the front panel 1 each</p> <p><i>Cannot be used on the following ranges:</i> IP 4820, IP 7500</p>	KI2A	60	IS	168	180	191	201	228	246	270	15	24	40	-	-
	KI2A	80	IS	205	216	227	237	262	280	303	21	30	46	-	-
	KI2A	90	IS	216	229	239	249	276	294	320	21	30	46	-	-
	KI2A	100	IS	232	242	251	261	287	298	332	21	30	46	-	-
	KI2A	120	IS	252	263	273	284	312	324	361	21	30	46	-	-
	ZIS 1				2	2	2	2	2	2	2	-	-	-	-
 <p>Hob base unit for compact dishwashers niche height 458 mm 1 drawer 253 mm high 1 cable protection shelf 1 edge protection bracket stainless steel coloured 1 front panel 461 mm high 1 metal plinth base</p> <p><i>Please state worktop thickness</i></p> <p><i>57 mm clearance to bottom edge of worktop.</i></p> <p><i>Specify appliance type</i></p> <p><i>During planning and installation, it is essential to observe the safety distances of the electrical appliance manufacturer!</i></p>	KIAG	60	S	139	151	162	174	206	215	233	5	8	8	-	-

2.46 The anti-tilt device which is supplied automatically must be fitted for room divider versions.

Hob base units optimised for induction and conventionally heated hobs

723 mm high

Unit without worktop and plinth, carcass depth 560 mm

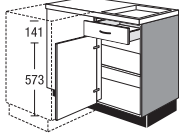
		Price group												
		width	1	2	3	4	5	6	7	Servosoft	Pro Servosoft	ProServoglass	Soft closing Top Motion	Soft closing Top Motion Plus
 <p>Corner hob base unit</p> <p>with smooth built-in panel and loose infill panel 50 mm wide in door finish or door colour for adding on base units</p> <ul style="list-style-type: none"> 1 drawer 1 protective shelf 1 hinged door 1 adjustable shelf <p><i>Planning dimension 1250 x 650 mm</i> <i>Carcass width 1000 mm</i></p> <p><i>May be pulled forward to balance dimensions. (minimum dimension: 1185 x 600 mm)</i></p> <p><i>The corner infill panel is supplied with returns for kitchens planned with adjacent dishwasher.</i> <i>Opening areas of appliances and drawers must be taken into account when planning smaller dimensions.</i></p> <p><i>An additional infill panel must be ordered for planning dimensions over 650 mm.</i></p> <p><i>Order hinged door opening limited Z19 separately if required.</i></p> <p><i>Please state worktop thickness</i></p> <p><i>40 mm clearance to bottom edge of worktop. Specify appliance type</i></p> <p><i>During planning and installation, it is essential to observe the safety distances of the electrical appliance manufacturer!</i></p>	EKIS	125	167	178	191	205	216	237	263	5	8	8	4	4
		with 60 cm door												

The anti-tilt device which is supplied automatically must be fitted for room divider versions.

Hob base units optimised for induction and conventionally heated hobs

723 mm high

Unit without worktop and plinth, carcass depth 560 mm

	width	Price group							Servosoft	Pro Servosoft	ProServoGlass	Soft closing Top Motion	Soft closing Top Motion Plus		
		1	2	3	4	5	6	7							
 <p>Corner hob base unit with smooth built-in panel and loose infill panel 50 mm wide in door finish or door colour for adding on base units 1 drawer 1 protective shelf 1 hinged door 2 fully pivotable wooden carousel shelves with LeMans metal rail with self-closing mechanism and cushioning effect</p> <p><i>Planning dimension 1250 x 650 mm Not to fall below planning dimension 1250 mm. (carcase width 1000 mm)</i></p> <p><i>May be pulled forward to balance dimensions. (minimum dimensions: 1250 x 600 mm)</i></p> <p><i>When planning kitchens with a dishwasher next to the corner unit, the corner trim is supplied with return. An additional infill panel must be ordered for planning dimensions over 650 mm.</i></p> <p><i>Please state worktop thickness</i></p> <p><i>40 mm clearance to bottom edge of worktop.</i></p> <p><i>Specify appliance type</i></p> <p><i>During planning and installation, it is essential to observe the safety distances of the electrical appliance manufacturer!</i></p>	EKIS	125	LMP	386	398	408	417	432	451	482	5	8	8	4	4
<p>Corner hob base unit same as above, but 2 fully pivotable wooden carousel shelves with LeMans metal rail</p>	EKIS	125	LM	360	372	382	391	407	425	455	5	8	8	4	4

2.48 The anti-tilt device which is supplied automatically must be fitted for room divider versions.

Hob base units optimised for gas hobs

723 mm high

Unit without worktop and plinth, carcass depth 560 mm

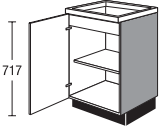
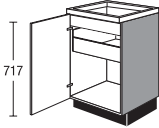
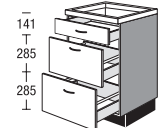
				Price group												
				width	1	2	3	4	5	6	7	Servosoft	Pro Servosoft	ProServoglass	Soft closing Top Motion	Soft closing Top Motion Plus
 <p>Hob base unit 1 hinged door 1 fixed inside panel 1 cable protection shelf 1 adjustable shelf</p> <p><i>Please state worktop thickness</i></p> <p><i>Specify appliance type</i></p> <p><i>During planning and installation, it is essential to observe the safety distances of the electrical appliance manufacturer!</i></p>	KG	40		61	64	69	75	87	92	99	-	-	-	4	4	
	KG	45		62	65	71	77	89	94	101	-	-	-	4	4	
	KG	50		63	69	74	79	91	96	103	-	-	-	4	4	
	KG	60		69	75	81	87	102	109	118	-	-	-	4	4	
 <p>Hob base unit 1 hinged door 1 fixed inside panel 1 cable protection shelf 1 internal drawer</p> <p><i>Please state worktop thickness</i></p> <p><i>Specify appliance type</i></p> <p><i>The hinged doors must open to an angle of at least 90° (observe handle spacing).</i></p> <p><i>During planning and installation, it is essential to observe the safety distances of the electrical appliance manufacturer!</i></p>	KG	45	IS	87	93	98	103	115	121	130	5	8	8	4	4	
	KG	50	IS	90	97	102	108	119	126	136	5	8	8	4	4	
	KG	60	IS	96	103	109	115	128	137	149	5	8	8	4	4	
 <p>Hob base unit 1 drawer 1 protective shelf 2 deep drawers</p> <p>Drawer at top 400 mm deep</p>	KGS2A	60	K1	173	185	191	198	219	231	250	-	9	25	-	-	
	KGS2A	80	K1	212	223	232	241	265	281	304	-	9	25	-	-	
	KGS2A	90	K1	215	226	235	244	268	284	307	-	9	25	-	-	
	KGS2A	100	K1	229	241	250	260	285	302	327	-	9	25	-	-	

The anti-tilt device which is supplied automatically must be fitted for room divider versions.

Hob base units for hob extractors

723 mm high

Unit without worktop and plinth, carcass depth 560 mm

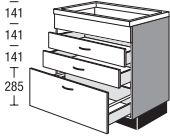
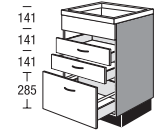
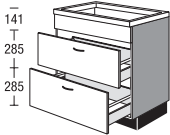
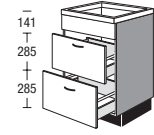
		width	Price group							Servosoft	Pro Servosoft	ProServoGlass	Soft closing Top Motion	Soft closing Top Motion Plus	
			1	2	3	4	5	6	7						
 <p>Hob base unit for hob extractor</p> <p>1 fixed front panel 2 drawers (reduced in depth depending on appliance) 1 deep drawer (reduced in depth depending on appliance)</p> <p><i>Specify appliance type</i></p> <p><i>Please state worktop thickness</i></p> <p><i>Depending on appliance, an adjustment must be made on site.</i></p> <p><i>We cannot accept responsibility for swelling damage due to circulating air mode.</i></p> <p><i>During planning and installation, it is essential to observe the safety distances of the electrical appliance manufacturer!</i></p>	KDB2SA	60		180	192	202	212	238	257	279	15	24	32	-	-
	KDB2SA	80		191	205	215	226	255	275	300	18	27	35	-	-
	KDB2SA	90		204	218	230	241	272	293	320	18	27	35	-	-
	KDB2SA	100		215	230	243	255	288	309	338	18	27	35	-	-
 <p>Hob base unit for hob extractor</p> <p>same as above, but with full-height back panel 1 fixed front panel 2 drawers 1 deep drawer</p> <p><i>Appliance must be suitable for non-ducted recirculating air.</i></p>	KDB2SA	60	U	180	192	202	212	238	257	279	15	24	32	-	-
	KDB2SA	80	U	191	205	215	226	255	275	300	18	27	35	-	-
	KDB2SA	90	U	204	218	230	241	272	293	320	18	27	35	-	-
	KDB2SA	100	U	215	230	243	255	288	309	338	18	27	35	-	-
 <p>Hob base unit for hob extractor</p> <p>1 fixed front panel 2 deep drawers (reduced in depth depending on appliance)</p> <p><i>Specify appliance type</i></p> <p><i>Please state worktop thickness</i></p> <p><i>Depending on appliance, an adjustment must be made on site.</i></p> <p><i>We cannot accept responsibility for swelling damage due to circulating air mode.</i></p> <p><i>During planning and installation, it is essential to observe the safety distances of the electrical appliance manufacturer!</i></p>	KDB2A	60		148	158	166	174	196	211	229	10	16	32	-	-
	KDB2A	80		153	164	172	181	204	220	240	16	22	38	-	-
	KDB2A	90		158	169	178	187	211	227	248	16	22	38	-	-
	KDB2A	100		163	174	184	193	218	234	256	16	22	38	-	-
	KDB2A	120		195	208	220	231	261	280	306	16	22	38	-	-
 <p>Hob base unit for hob extractor</p> <p>same as above, but with full-height back panel 1 fixed front panel 2 deep drawers</p> <p><i>Appliance must be suitable for non-ducted recirculating air.</i></p>	KDB2A	60	U	148	158	166	174	196	211	229	10	16	32	-	-
	KDB2A	80	U	153	164	172	181	204	220	240	16	22	38	-	-
	KDB2A	90	U	158	169	178	187	211	227	248	16	22	38	-	-
	KDB2A	100	U	163	174	184	193	218	234	256	16	22	38	-	-
	KDB2A	120	U	195	208	220	231	261	280	306	16	22	38	-	-

2.50 The anti-tilt device which is supplied automatically must be fitted for room divider versions.

Hob base units for hob extractors

723 mm high

Unit without worktop and plinth, carcass depth 560 mm

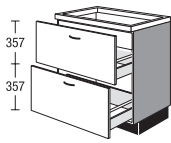
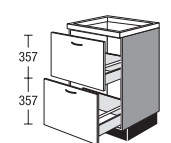
		width	Price group							Servosoft	Pro Servosoft	ProServoglass	Soft closing Top Motion	Soft closing Top Motion Plus	
			1	2	3	4	5	6	7						
 <p>Hob base unit for hob extractor 2 deep drawers (reduced in depth depending on appliance) <i>Specify appliance type</i> <i>Please state worktop thickness</i> <i>Depending on appliance, an adjustment must be made on site.</i> <i>We cannot accept responsibility for swelling damage due to circulating air mode.</i> <i>During planning and installation, it is essential to observe the safety distances of the electrical appliance manufacturer!</i></p>	KD2A	60		143	153	160	168	189	204	221	10	16	32	-	-
	KD2A	80		148	159	166	175	197	213	232	16	22	38	-	-
	KD2A	90		153	164	172	181	204	220	240	16	22	38	-	-
	KD2A	100		158	169	178	187	211	227	248	16	22	38	-	-
	KD2A	120		190	203	214	225	254	273	298	16	22	38	-	-
 <p>Hob base unit for hob extractor same as above, but with full-height back panel 2 deep drawers <i>Appliance must be suitable for non-ducted recirculating air.</i></p>	NEW KD2A	60	U	143	153	160	168	189	204	221	10	16	32	-	-
	NEW KD2A	80	U	148	159	166	175	197	213	232	16	22	38	-	-
	NEW KD2A	90	U	153	164	172	181	204	220	240	16	22	38	-	-
	NEW KD2A	100	U	158	169	178	187	211	227	248	16	22	38	-	-
	NEW KD2A	120	U	190	203	214	225	254	273	298	16	22	38	-	-

The anti-tilt device which is supplied automatically must be fitted for room divider versions.

Sink base units

579 / 723 mm high

Unit without worktop and plinth, carcass depth 560 mm

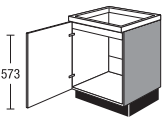
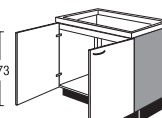
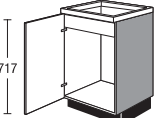
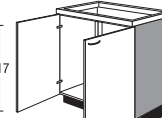
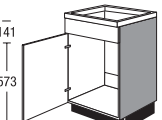
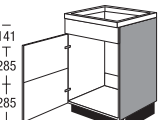
		width	Price group							Servosoft	Pro Servosoft	ProServoGlass	Soft closing Top Motion	Soft closing Top Motion Plus	
			1	2	3	4	5	6	7						
 <p>Sink base unit 579 mm high 1 hinged door 1 fixed inside panel</p>	SP	60	58	60	66	71	76	89	91	98	-	-	-	4	4
 <p>Sink base unit 579 mm high 2 fixed infill panels</p>	SP	90	58	85	93	100	108	128	139	153	-	-	-	8	8
	SP	100	58	86	95	102	110	129	142	159	-	-	-	8	8
 <p>Sink base unit 1 hinged door 1 fixed inside panel</p>	SP	45		57	61	64	68	72	77	85	-	-	-	4	4
	SP	50		59	63	66	70	76	82	91	-	-	-	4	4
	SP	60		61	67	72	77	90	93	99	-	-	-	4	4
<p>Sink base unit same as above, but with full-height back panel</p>	SP	45	RW	67	71	74	78	82	87	95	-	-	-	4	4
	SP	50	RW	69	73	76	80	86	92	101	-	-	-	4	4
	SP	60	RW	71	77	82	87	100	103	110	-	-	-	4	4
 <p>Sink base unit 2 hinged doors</p>	SP	80		85	93	100	108	128	139	153	-	-	-	8	8
	SP	90		86	94	101	109	129	141	155	-	-	-	8	8
	SP	100		87	96	103	111	131	144	161	-	-	-	8	8
	SP	120		106	115	122	130	150	163	180	-	-	-	8	8
<p>Sink base unit same as above, but with full-height back panel</p>	SP	80	RW	88	96	103	111	131	142	156	-	-	-	8	8
	SP	90	RW	96	104	111	119	139	151	166	-	-	-	8	8
	SP	100	RW	97	106	113	121	141	154	171	-	-	-	8	8
	SP	120	RW	114	123	130	138	158	171	189	-	-	-	8	8
 <p>Sink base unit 1 fixed front panel 1 hinged door</p>	SPB	40		56	59	60	62	69	75	83	-	-	-	4	4
	SPB	45		57	61	64	68	72	77	85	-	-	-	4	4
	SPB	50		59	63	66	70	76	82	91	-	-	-	4	4
	SPB	60		61	67	72	77	90	93	99	-	-	-	4	4
<p>Sink base unit same as above, but with full-height back panel</p>	SPB	40	RW	66	69	70	72	79	85	93	-	-	-	4	4
	SPB	45	RW	67	71	74	78	82	87	95	-	-	-	4	4
	SPB	50	RW	69	73	76	80	86	92	101	-	-	-	4	4
	SPB	60	RW	71	77	82	87	100	103	110	-	-	-	4	4
 <p>Sink base unit 1 fixed front panel 1 door (dowelled)</p>	SPB	45	M2	59	65	66	72	76	79	87	-	-	-	4	4
	SPB	50	M2	61	67	68	74	80	84	93	-	-	-	4	4
	SPB	60	M2	63	71	74	81	94	95	101	-	-	-	4	4

2.52

The anti-tilt device which is supplied automatically must be fitted for room divider versions.

Sink base units

579 / 723 mm high

Unit without worktop and plinth, carcass depth 560 mm

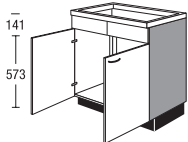
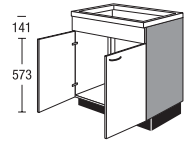
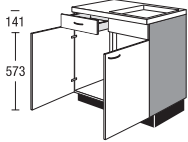
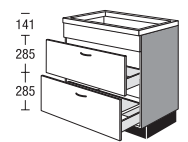
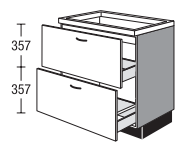
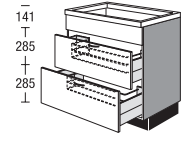
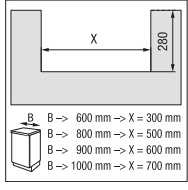
				Price group												
				width	1	2	3	4	5	6	7	Servosoft	Pro Servosoft	ProServoglass	Soft closing Top Motion	Soft closing Top Motion Plus
 <p>Sink base unit 2 fixed front panels 2 hinged doors</p>	SPB	80		85	93	100	108	128	139	153	-	-	-	8	8	
	SPB	90		86	94	101	109	129	141	155	-	-	-	8	8	
	SPB	100		87	96	103	111	131	144	161	-	-	-	8	8	
	SPB	120		98	107	114	122	142	155	172	-	-	-	8	8	
	SPB	80	RW	95	103	110	118	138	149	164	-	-	-	8	8	
	SPB	90	RW	97	105	112	120	140	152	167	-	-	-	8	8	
	SPB	100	RW	98	107	114	122	142	155	172	-	-	-	8	8	
	SPB	120	RW	113	122	129	137	157	170	188	-	-	-	8	8	
 <p>Sink base unit 1 fixed front panel 2 hinged doors</p>	SPB	80	3	90	98	105	113	133	144	159	-	-	-	8	8	
	SPB	90	3	92	100	107	115	135	147	162	-	-	-	8	8	
	SPB	100	3	96	104	111	119	139	151	166	-	-	-	8	8	
 <p>Sink base unit 1 drawer 1 fixed front panel 2 hinged doors</p> <p><i>SPSB = Basin right</i> <i>SPBS = Basin left</i></p> <p>SPSB for basin on right</p>	SPSB	90		99	107	115	124	146	159	176	5	8	8	8	8	
	SPBS	90		99	107	115	124	146	159	176	5	8	8	8	8	
	SPSB	100		102	111	119	128	150	164	182	5	8	8	8	8	
	SPBS	100		102	111	119	128	150	164	182	5	8	8	8	8	
 <p>Sink base unit 1 fixed front panel 1 drawer 285 mm high, 270 mm deep 1 pull-out 270 mm deep</p>	SPB2A	80	SK2	159	169	177	185	206	220	239	13	19	27	-	-	
	SPB2A	90	SK2	168	178	186	194	215	229	249	13	19	27	-	-	
	SPB2A	100	SK2	177	187	195	203	229	244	264	13	19	27	-	-	
 <p>Sink base unit 1 drawer 357 mm high, 270 mm deep 1 fixed infill panel 1 pull-out 270 mm deep</p>	SP2A	80	SK2	158	167	175	183	203	216	235	13	19	27	-	-	
	SP2A	90	SK2	167	176	183	190	209	222	240	13	19	27	-	-	
	SP2A	100	SK2	175	183	189	197	228	243	263	13	19	27	-	-	
 <p>Sink base unit for Quooker systems 1 fixed front panel 1 deep drawer 1 deep drawer Deep drawers with cut-out in middle, approx. 275 mm deep</p> <p>III. shows 90 cm width</p> 	SPB2A	60	Q	226	242	255	267	302	325	355	10	16	32	-	-	
	SPB2A	80	Q	229	243	255	266	297	317	345	16	22	38	-	-	
	SPB2A	90	Q	241	255	266	278	308	329	356	16	22	38	-	-	
	SPB2A	100	Q	254	268	279	291	321	341	370	16	22	38	-	-	

The anti-tilt device which is supplied automatically must be fitted for room divider versions.

Sink base units

579 / 723 mm high

Unit without worktop and plinth, carcass depth 560 mm

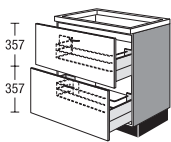
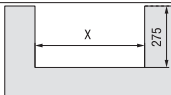
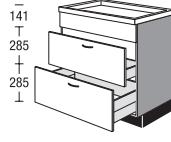
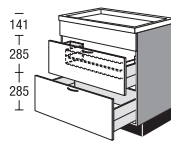
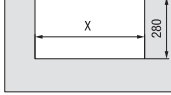
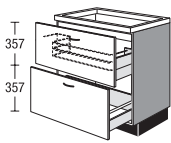
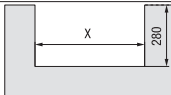
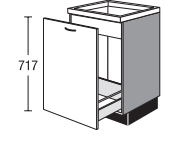
		width		Price group							Servosoft	Pro Servosoft	ProServoGlass	Soft closing Top Motion	Soft closing Top Motion Plus
				1	2	3	4	5	6	7					
 <p>Sink base unit for Quooker systems 1 fixed inside panel 2 deep drawers Deep drawers with cut-out in middle, approx. 275 mm deep</p> <p>Ill. shows 90 cm width</p>  <p>B → 600 mm → X = 300 mm B → 800 mm → X = 500 mm B → 900 mm → X = 600 mm B → 1000 mm → X = 700 mm B → 1200 mm → X = 900 mm</p>	SP2A	60	Q	220	234	243	254	283	301	328	10	16	32	-	-
	SP2A	80	Q	225	238	249	260	289	308	334	16	22	38	-	-
	SP2A	90	Q	238	250	260	271	298	316	341	16	22	38	-	-
	SP2A	100	Q	247	258	266	277	301	318	342	16	22	38	-	-
	SP2A	120	Q	295	308	318	331	359	380	408	16	22	38	-	-
 <p>Sink base unit 1 fixed front panel 1 drawer 285 mm high 270 mm deep 1 deep drawer</p>	SPB2A	60	S	139	149	157	165	186	200	218	10	16	24	-	-
	SPB2A	80	S	162	172	180	188	210	224	244	13	19	27	-	-
	SPB2A	90	S	171	181	189	197	219	233	253	13	19	27	-	-
	SPB2A	100	S	180	190	198	206	227	242	262	13	19	27	-	-
 <p>Sink base unit 1 fixed front panel 2 deep drawers top deep drawer with central cutout for drain approx. 580 mm wide, approx. 325 mm deep</p>  <p>B → 600 mm → X = 300 mm B → 800 mm → X = 500 mm B → 900 mm → X = 600 mm B → 1000 mm → X = 700 mm B → 1200 mm → X = 900 mm</p>	SPB2A	60		158	169	178	187	211	227	248	10	16	32	-	-
	SPB2A	80		179	190	199	208	232	248	270	16	22	38	-	-
	SPB2A	90		190	201	210	219	243	259	281	16	22	38	-	-
	SPB2A	100		201	212	221	230	254	270	293	16	22	38	-	-
	SPB2A	120		243	256	267	278	307	326	354	16	22	38	-	-
 <p>Sink base unit 2 deep drawers top deep drawer with central cutout for drain approx. 580 mm wide, approx. 325 mm deep 1 fixed inside panel</p>  <p>B → 600 mm → X = 300 mm B → 800 mm → X = 500 mm B → 900 mm → X = 600 mm B → 1000 mm → X = 700 mm B → 1200 mm → X = 900 mm</p>	SP2A	60		179	190	198	207	230	245	267	10	16	32	-	-
	SP2A	80		187	198	207	216	240	256	278	16	22	38	-	-
	SP2A	90		196	206	214	223	245	260	281	16	22	38	-	-
	SP2A	100		205	214	221	230	250	264	284	16	22	38	-	-
	SP2A	120		240	251	259	269	293	309	332	16	22	38	-	-
 <p>Sink base unit 1 deep drawer 1 fixed inside panel</p>	SPA	45		63	65	67	69	74	75	82	5	8	16	-	-
	SPA	50		73	75	77	80	86	87	94	5	8	16	-	-
	SPA	60		78	81	83	86	92	94	101	5	8	16	-	-





2.54

The anti-tilt device which is supplied automatically must be fitted for room divider versions.

Sink base units

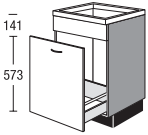
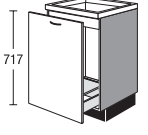
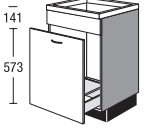
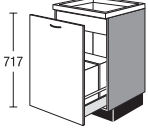
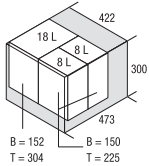
579 / 723 mm high

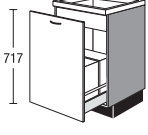
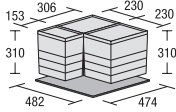
Unit without worktop and plinth, carcass depth 560 mm

				Price group												
				width	1	2	3	4	5	6	7	Servosoft	Pro Servosoft	ProServoglass	Soft closing Top Motion	Soft closing Top Motion Plus
 <p>Sink base unit 1 fixed front panel 1 deep drawer</p>	SPBA	45		66	68	70	73	78	79	86	5	8	16	-	-	
	SPBA	50		76	79	81	83	89	91	98	5	8	16	-	-	
	SPBA	60		81	84	86	89	96	97	106	5	8	16	-	-	
 <p>Sink base unit 1 deep drawer depth 400 mm 1 fixed inside panel</p>	SPA	45	K1	74	76	79	81	87	88	96	-	3	11	-	-	
	SPA	50	K1	85	87	90	93	100	101	109	-	3	11	-	-	
	SPA	60	K1	92	96	98	101	109	111	119	-	3	11	-	-	
 <p>Sink base unit 1 infill panel 1 deep drawer depth 400 mm</p>	SPBA	45	K1	77	79	82	85	91	92	100	-	3	11	-	-	
	SPBA	50	K1	88	91	94	96	103	105	113	-	3	11	-	-	
	SPBA	60	K1	95	99	101	104	113	114	124	-	3	11	-	-	
 <p>Sink base unit 1 deep drawer with waste bin for waste separation 1 fixed inside panel</p> <p>with 3 waste containers Capacity 1 x 18 litre container 2 x 8 litre containers 1 lid for 8 litre containers Organisation system</p> <p><i>Bottom edge carcass to top edge waste container approx. 350 mm</i></p>  <p>III. shows 60 cm width</p> 	SPA	50	M	154	160	164	170	182	185	200	5	8	16	-	-	
	SPA	60	M	159	165	169	175	187	190	205	5	8	16	-	-	
 <p>Sink base unit 1 deep drawer with waste separation system consisting of: 2 containers 17 litres each, each with lid 1 container 8 litres with lid 1 base panel</p> <p>1 fixed inside panel</p>  	SPA	60	M1	126	131	134	139	148	152	163	5	8	16	-	-	





The anti-tilt device which is supplied automatically must be fitted for room divider versions.

2.55

Sink base units

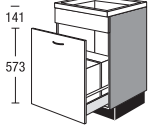
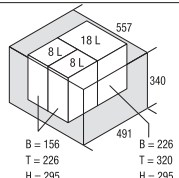
579 / 723 mm high

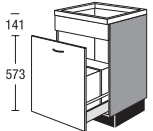
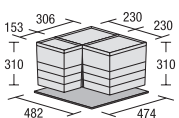
Unit without worktop and plinth, carcass depth 560 mm

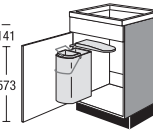
		width	Price group												
			1	2	3	4	5	6	7	Servosoft	Pro Servosoft	ProServoGlass	Soft closing Top Motion	Soft closing Top Motion Plus	
 <p>Sink base unit 1 fixed front panel 1 deep drawer with waste bin for waste separation</p> <p>with 3 waste containers Capacity 1 x 18 litre container 2 x 8 litre containers 1 lid for 8 litre containers Organisation system</p> <p><i>Bottom edge carcass to top edge waste container approx. 350 mm</i></p>  <p>Ill. shows 60 cm width</p> 	SPBA	50	M	157	163	168	173	186	189	204	5	8	16	-	-
		SPBA	60	M	162	168	173	178	191	194	210	5	8	16	-
 <p>Sink base unit 1 fixed front panel 1 deep drawer with waste separation system consisting of: 2 containers 17 litres each, each with lid 1 container 8 litres with lid 1 base panel</p>  	SPBA	60	M1	130	135	138	143	154	156	169	5	8	16	-	-
 <p>Sink base unit</p> <p>1 fixed front panel 1 hinged door 1 waste bin with 1 container 14 litres 1 container 5 litres</p> <p><i>Unit leaves factory ready fitting waste bin</i></p> <p>NEW NEW NEW</p>	SPB	45	MT1	96	103	108	115	121	130	143	-	-	-	4	4
	SPB	50	MT1	98	105	110	116	126	136	151	-	-	-	4	4
	SPB	60	MT1	100	110	118	126	148	152	162	-	-	-	4	4

2.56 The anti-tilt device which is supplied automatically must be fitted for room divider versions.

Sink base units

579 / 723 mm high

Unit without worktop and plinth, carcass depth 560 mm

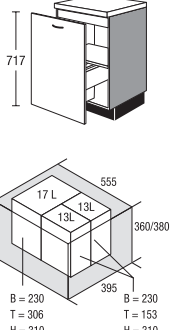
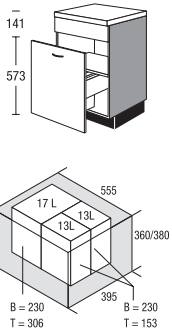
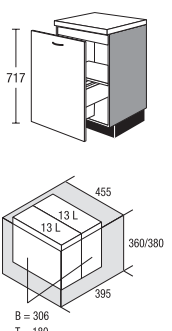
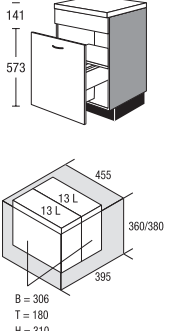
		width	Price group							Servosoft	Pro Servosoft	ProServoglass	Soft closing Top Motion	Soft closing Top Motion Plus	
			1	2	3	4	5	6	7						
 <p>Sink base unit 1 deep drawer 1 fixed inside panel 1 cover panel 3 waste bins Capacity 2 containers 13 litres 1 container 17 litres</p>	SPA	60	MH3	195	202	207	215	229	233	251	-	3	3	-	-
	 <p>Sink base unit 1 deep drawer 1 fixed front panel 1 cover panel 3 waste bins Capacity 2 containers 13 litres 1 container 17 litres</p>	SPBA	60	MH3	200	207	212	221	235	239	257	-	3	3	-
 <p>Sink base unit 1 deep drawer 1 fixed inside panel 1 cover panel 2 containers Capacity 2 containers 13 litres</p>	SPA SPA	50 60	MH2 MH2	178 184	185 191	190 196	196 203	210 216	214 220	231 237	- -	3 3	3 3	- -	- -
	 <p>Sink base unit 1 deep drawer 1 fixed front panel 1 cover panel 2 waste bins Capacity 2 containers 13 litres</p>	SPBA SPBA	50 60	MH2 MH2	183 189	190 196	195 201	202 209	216 222	220 226	237 243	- -	3 3	3 3	- -

The anti-tilt device which is supplied automatically must be fitted for room divider versions.

Sink base units

579 / 723 mm high

Unit without worktop and plinth, carcass depth 560 mm

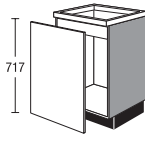
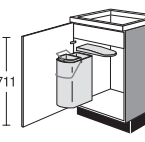
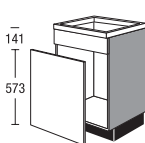
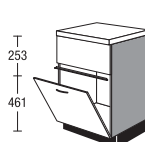
				Price group												
				width	1	2	3	4	5	6	7	ServoSoft	Pro ServoSoft	ProServoGlass	Soft closing Top Motion	Soft closing Top Motion Plus
 <p>Sink base unit 1 separate front without handle drilling 1 handle 1 fixed inside panel <i>For on-site installation of a waste collection system with deep drawer.</i></p>	SP	45	T	50	52	53	55	59	60	65	-	-	-	-	-	-
	SP	50	T	53	54	56	58	62	63	68	-	-	-	-	-	-
	SP	60	T	58	60	62	64	69	70	75	-	-	-	-	-	-
	SP	45	TRW	60	62	63	65	69	70	75	-	-	-	-	-	-
	SP	50	TRW	63	64	66	68	72	73	78	-	-	-	-	-	-
	SP	60	TRW	68	70	72	74	79	80	86	-	-	-	-	-	-
 <p>Sink base unit 1 hinged door 1 fixed inside panel 1 waste bin 1 container 14 litres 1 container 5 litres <i>Unit leaves factory ready fitting waste bin</i></p>	NEW SP	45	MT1	96	103	108	115	121	130	143	-	-	-	4	4	
	NEW SP	50	MT1	98	105	110	116	126	136	151	-	-	-	4	4	
	NEW SP	60	MT1	100	110	118	126	148	152	162	-	-	-	4	4	
 <p>Sink base unit 1 fixed front panel 1 separate front without handle drilling 1 handle <i>For on-site installation of a waste collection system with deep drawer.</i></p>	SPB	45	T	58	62	65	69	73	78	86	-	-	-	-	-	
	SPB	50	T	60	64	67	71	77	83	92	-	-	-	-	-	
	SPB	60	T	62	68	73	78	91	94	100	-	-	-	-	-	
 <p>Sink base unit for compact dishwashers niche height 458 mm 1 fixed front panel 253 mm high 1 edge protection bracket stainless steel coloured 1 front panel 461 mm high 1 metal plinth base <i>Include extra-deep worktop in planning!</i> Specify appliance type During planning and installation, it is essential to observe the safety distances of the electrical appliance manufacturer! Use of space-saving waste and trap ZSZ 1 G is recommended.</p>	NEW SPBG	60		113	123	132	141	167	175	189	-	-	-	-	-	

2.58 The anti-tilt device which is supplied automatically must be fitted for room divider versions.

Sink base units

579 / 723 mm high

Unit without worktop and plinth, carcass depth 560 mm

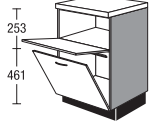
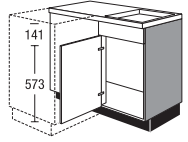
		width	Price group							Servosoft	Pro Servosoft	ProServoglass	Soft closing Top Motion	Soft closing Top Motion Plus		
			1	2	3	4	5	6	7							
 <p>Sink base unit for compact dishwashers NEW</p> <p>niche height 458 mm</p> <ul style="list-style-type: none"> 1 flap door 253 mm high 1 fixed shelf 1 edge protection bracket stainless steel coloured 1 front panel 461 mm high 1 metal plinth base <p><i>Include extra-deep worktop in planning!</i></p> <p><i>Specify appliance type</i></p> <p><i>During planning and installation, it is essential to observe the safety distances of the electrical appliance manufacturer!</i></p> <p><i>Use of space-saving waste and trap ZSZ 1 G is recommended.</i></p> <p><i>Cannot be combined with handle no. 783.</i></p>	SPKG	60	125	136	146	156	185	193	210	-	-	-	-	-		
	 <p>Corner sink base unit</p> <ul style="list-style-type: none"> with smooth mounting panel and loose panel 50 mm wide, in door colour for mounting base units 1 fixed front panel 1 hinged door <p><i>Planning dimension 1050 x 650 mm</i> <i>Carcass width 900 mm</i></p> <p><i>May be pulled forward to balance dimensions. (minimum dimension: 985 x 600 mm)</i></p> <p><i>Installation of the waste bin ZAT 40 is not possible.</i></p> <p><i>The corner infill panel is supplied with returns for kitchens planned with adjacent dishwasher.</i></p> <p><i>An additional infill panel must be ordered for planning dimensions over 650 mm.</i></p> <p><i>Order hinged door opening limited Z19 separately if required.</i></p> <p><i>Cannot be combined with drip insert EZIT...A.</i></p>		SPEB	105	97	107	114	121	132	145	162	-	-	-	4	4
<p>Corner sink base unit</p> <p>same as above, but with full-height back panel</p>		SPEB	105	RW	107	117	124	131	142	155	172	-	-	-	4	4

The anti-tilt device which is supplied automatically must be fitted for room divider versions.

Sink base units

579 / 723 mm high

Unit without worktop and plinth, carcass depth 560 mm

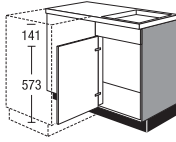
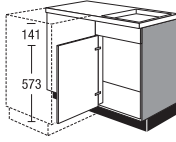
	width	Price group							Servosoft	Pro Servosoft	ProServoGlass	Soft closing Top Motion	Soft closing Top Motion Plus	
		1	2	3	4	5	6	7						
 <p>Corner sink base unit with smooth mounting panel and loose panel 50 mm wide, in door colour for mounting base units 1 fixed front panel 1 hinged door</p> <p><i>Planning dimension 1100 x 650 mm Carcass width 900 mm</i></p> <p><i>May be pulled forward to balance dimensions. (minimum dimension: 1035 x 600 mm)</i></p> <p><i>Installation of the waste bin ZAT 40 is not possible.</i></p> <p><i>The corner infill panel is supplied with returns for kitchens planned with adjacent dishwasher.</i></p> <p><i>An additional infill panel must be ordered for planning dimensions over 650 mm.</i></p> <p><i>Order hinged door opening limited Z19 separately if required.</i></p>	SPEB 110 with 45 cm door		100	110	118	125	136	149	167	-	-	-	4	4
	SPEB 110 with 45 cm door	RW	110	120	127	135	146	159	177	-	-	-	4	4
 <p>Corner sink base unit with smooth mounting panel and loose panel 50 mm wide, in door colour for mounting base units 1 fixed front panel 1 hinged door</p> <p><i>Planning dimension 1150 x 650 mm Carcass width 1000 mm</i></p> <p><i>May be pulled forward to balance dimensions. (minimum dimension: 1085 x 600 mm)</i></p> <p><i>Installation of the waste bin ZAT 40 is not possible.</i></p> <p><i>The corner infill panel is supplied with returns for kitchens planned with adjacent dishwasher.</i></p> <p><i>An additional infill panel must be ordered for planning dimensions over 650 mm.</i></p> <p><i>Order hinged door opening limited Z19 separately if required.</i></p>	SPEB 115 with 50 cm door		101	109	116	123	134	147	164	-	-	-	4	4
	SPEB 115 with 50 cm door	RW	111	119	126	133	144	157	174	-	-	-	4	4

2.60 The anti-tilt device which is supplied automatically must be fitted for room divider versions.

Sink base units

579 / 723 mm high

Unit without worktop and plinth, carcass depth 560 mm

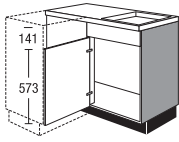
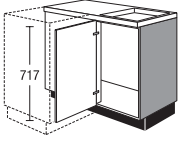
		Price group														
		width		1	2	3	4	5	6	7	Servosoft	Pro Servosoft	ProServoglass	Soft closing Top Motion	Soft closing Top Motion Plus	
 <p>Version L</p>	<p>Corner sink base unit with smooth add-on panel, 400 mm wide, and loose infill panel, in door finish and door colours for adding base units 1 fixed front panel 1 hinged door</p> <p><i>Planning dimension 1250 x 650 mm Carcass width 1000 mm</i></p> <p><i>May be pulled forward to balance dimensions. (minimum dimension: 1185 x 600 mm)</i></p> <p><i>Installation of the waste bin ZAT 40 is not possible.</i></p> <p><i>The corner infill panel is supplied with returns for kitchens planned with adjacent dishwasher.</i></p> <p><i>An additional infill panel must be ordered for planning dimensions over 650 mm.</i></p> <p><i>Order hinged door opening limited Z19 separately if required.</i></p> <p><i>Cannot be combined with drip insert EZIT...A.</i></p>	SPEB	125 with 60 cm door		103	113	121	130	148	158	172	-	-	-	4	4
	<p>Corner sink base unit same as above, but with full-height back panel</p>	SPEB	125 with 60 cm door	RW	113	123	131	140	158	168	182	-	-	-	4	4
 <p>Version L</p>	<p>Corner sink base unit with full-height back panel with smooth built-in panel and loose infill panel 50 mm wide in door finish or door colour for adding on base units 1 hinged door</p> <p><i>Planning dimension 1050 x 650 mm Carcass width 900 mm</i></p> <p><i>May be pulled forward to balance dimensions. (minimum dimension: 985 x 600 mm)</i></p> <p><i>Installation of the waste bin ZAT 40 is not possible.</i></p> <p><i>The corner infill panel is supplied with returns for kitchens planned with adjacent dishwasher.</i></p> <p><i>An additional infill panel must be ordered for planning dimensions over 650 mm.</i></p> <p><i>Order hinged door opening limited Z19 separately if required.</i></p> <p><i>Cannot be combined with drip insert EZIT...A.</i></p>	SPE	105 with 40 cm door	RW	107	117	124	131	142	155	172	-	-	-	4	4
	<p>Corner sink base unit same as above, but</p> <p><i>Planning dimension 1100 x 650 mm Carcass width 900 mm</i></p> <p><i>May be pulled forward to balance dimensions. (minimum dimension: 1035 x 600 mm)</i></p>	SPE	110 with 45 cm door	RW	110	120	127	135	146	159	177	-	-	-	4	4

The anti-tilt device which is supplied automatically must be fitted for room divider versions.

2.61

Sink base units

579 / 723 mm high

Unit without worktop and plinth, carcass depth 560 mm

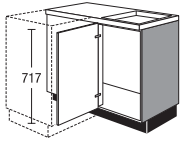
		width		Price group							Servosoft	Pro Servosoft	ProServoGlass	Soft closing Top Motion	Soft closing Top Motion Plus
				1	2	3	4	5	6	7					
<p>Corner sink base unit same as above, but</p> <p><i>Planning dimension 1150 x 650 mm</i> <i>Carcass width 1000 mm</i></p> <p><i>May be pulled forward to balance dimensions.</i> <i>(minimum dimension: 1085 x 600 mm)</i></p>	SPE	115	RW	111	119	126	133	144	157	174	-	-	-	4	4
	with 50 cm door														
<p>Corner sink base unit same as above, but</p> <p><i>Planning dimension 1250 x 650 mm</i> <i>Carcass width 1000 mm</i></p> <p><i>May be pulled forward to balance dimensions.</i> <i>(minimum dimension: 1185 x 600 mm)</i></p>	SPE	125	RW	113	123	131	140	158	168	182	-	-	-	4	4
	with 60 cm door														
 <p>Version L</p> <p>Corner sink base unit with smooth mounting panel and loose panel 50 mm wide, in door colour for mounting base units 1 hinged door</p> <p><i>With full-height door</i></p> <p><i>Planning dimension 1100 x 650 mm</i> <i>Carcass width 900 mm</i></p> <p><i>May be pulled forward to balance dimensions.</i> <i>(minimum dimension: 1040 x 600 mm)</i></p> <p><i>Installation of the waste bin ZAT 40 is not possible.</i></p> <p><i>The corner infill panel is supplied with returns for kitchens planned with adjacent dishwasher.</i></p> <p><i>An additional infill panel must be ordered for planning dimensions over 650 mm.</i></p> <p><i>Order hinged door opening limited Z19 separately if required.</i></p>	SPE	110		100	110	118	125	136	149	167	-	-	-	4	4
	with 45 cm door														
<p>Corner sink base unit same as above, but</p> <p><i>Planning dimension 1150 x 650 mm</i> <i>Carcass width 1000 mm</i></p> <p><i>May be pulled forward to balance dimensions.</i> <i>(minimum dimension: 1085 x 600 mm)</i></p>	SPE	115		101	109	116	123	134	147	164	-	-	-	4	4
	with 50 cm door														

2.62 The anti-tilt device which is supplied automatically must be fitted for room divider versions.

Sink base units

579 / 723 mm high

Unit without worktop and plinth, carcass depth 560 mm

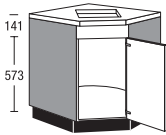
		width	Price group							Servosoft	Pro Servosoft	ProServoglass	Soft closing Top Motion	Soft closing Top Motion Plus
			1	2	3	4	5	6	7					
	<p>Corner sink base unit</p> <p>1 fixed front panel 1 hinged door</p> <p><i>Suitable corner worktop PLR/PLS 4390 60</i></p> <p><i>Oven housing unit cannot be added on due to worktop connection.</i></p> <p><i>Installation of the waste bin ZAT 40 is not possible.</i></p> <p><i>780 mm door opening necessary, the unit can, however, be dismantled on site.</i></p>	<p>SPEBD 90 with 45 cm door</p>	135	148	151	154	172	184	200	-	-	-	4	4

The anti-tilt device which is supplied automatically must be fitted for room divider versions.

Decor panels and front panels

723 mm high

Unit without worktop and plinth, carcass depth 560 mm

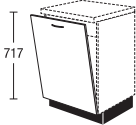
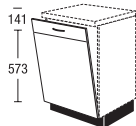
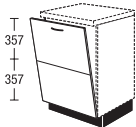
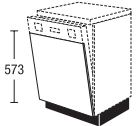
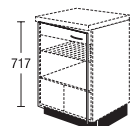
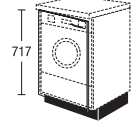
		width	Price group							Servosoft	Pro Servosoft	ProServoGlass	Soft closing Top Motion	Soft closing Top Motion Plus
			1	2	3	4	5	6	7					
	Vapour guard above dishwashers 90 mm deep, 1.5 mm thick	ZV 449 stainless steel-effect ZV 599 stainless steel-effect												
	Front panel for fully integrated built-under dishwashers <i>Specify appliance type</i>	TGV 45 TGV 60												
	Front panel for fully integrated built-under dishwashers with pinned front <i>Not available for the following ranges: IP 4820, IP 7500</i> <i>Specify appliance type</i> <i>Top grip ledge on upper part of front</i>	TGV 45 MS TGV 60 MS												
	Front panel for fully integrated built-under dishwashers with pinned front <i>Specify appliance type</i> <i>Top grip ledge on upper part of front</i> <i>Not available for the following ranges: IP 4820, IP 7500</i>	TGV 60 M2												
	Front panel For semi-integrated built-under dishwashers <i>Specify appliance type</i> <i>Front component in ranges IP 4820 and IP 7500 with recessed grip.</i>	TG 45 TG 60												
	Base unit door for built-under integrated refrigerators and freezers. <i>Specify appliance type</i>	TK 60 TK 60 F												
	Front panel for fully integrated built-under washing machines <i>Specify appliance type The item No. may differ depending on appliance type!</i>	TWV 60 8												

2.64 The anti-tilt device which is supplied automatically must be fitted for room divider versions.

Decor panels and front panels

723 mm high

Unit without worktop and plinth, carcass depth 560 mm

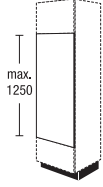

Decor panel for appliances

max. size:
1250 mm high, 597 mm wide

When ordering, size of front surface panel and appliance type must be stated!

Available in all carcass finishes.

DB

width

60

125

Price group

1 2 3 4 5 6 7

20 20 20 20 20 20 20

Servosoft
Pro Servosoft
ProServoglass
Soft closing Top Motion
Soft closing Top Motion Plus

- - - - -

The anti-tilt device which is supplied automatically must be fitted for room divider versions.

2.65

Notes

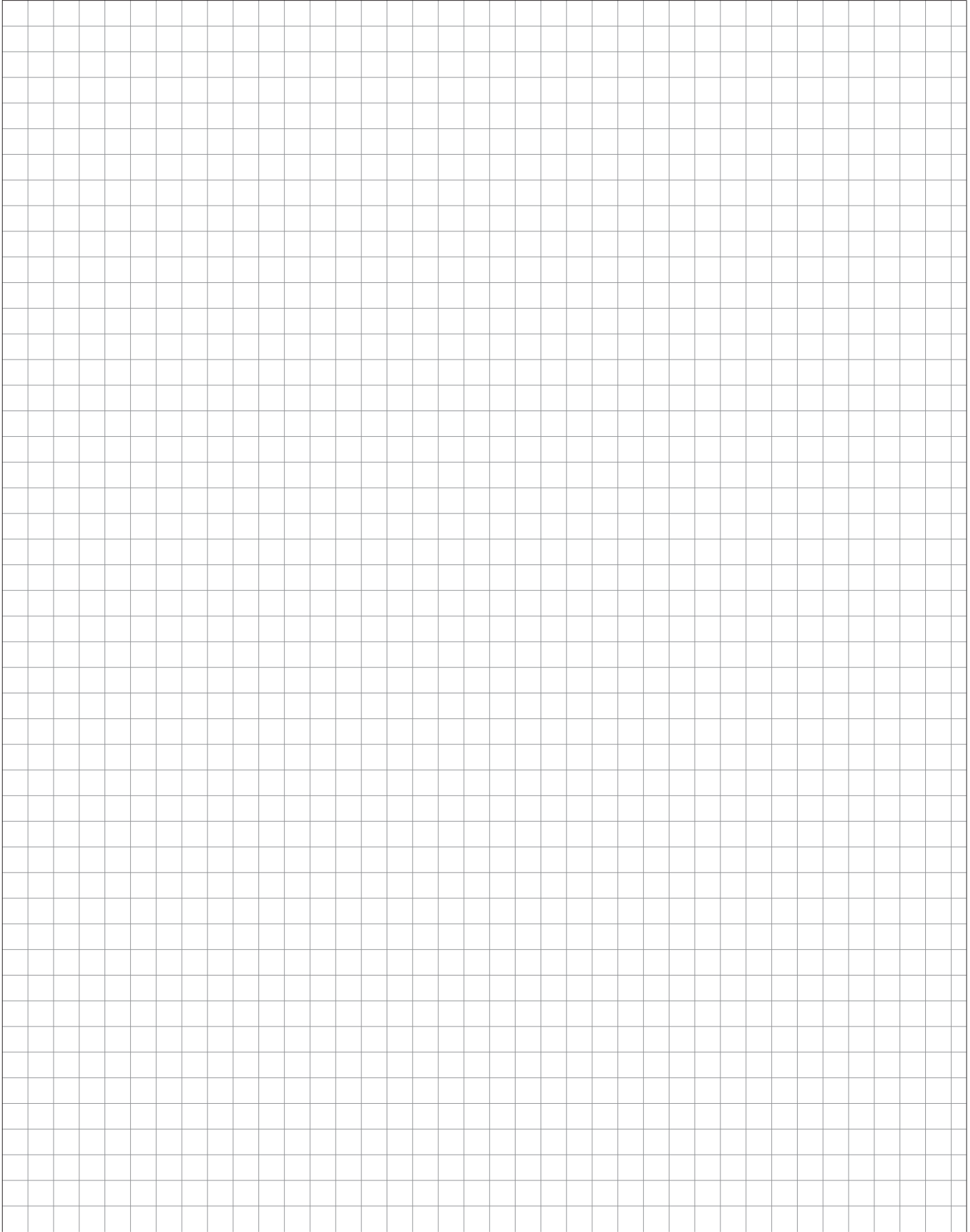

MAXI base units 867 mm

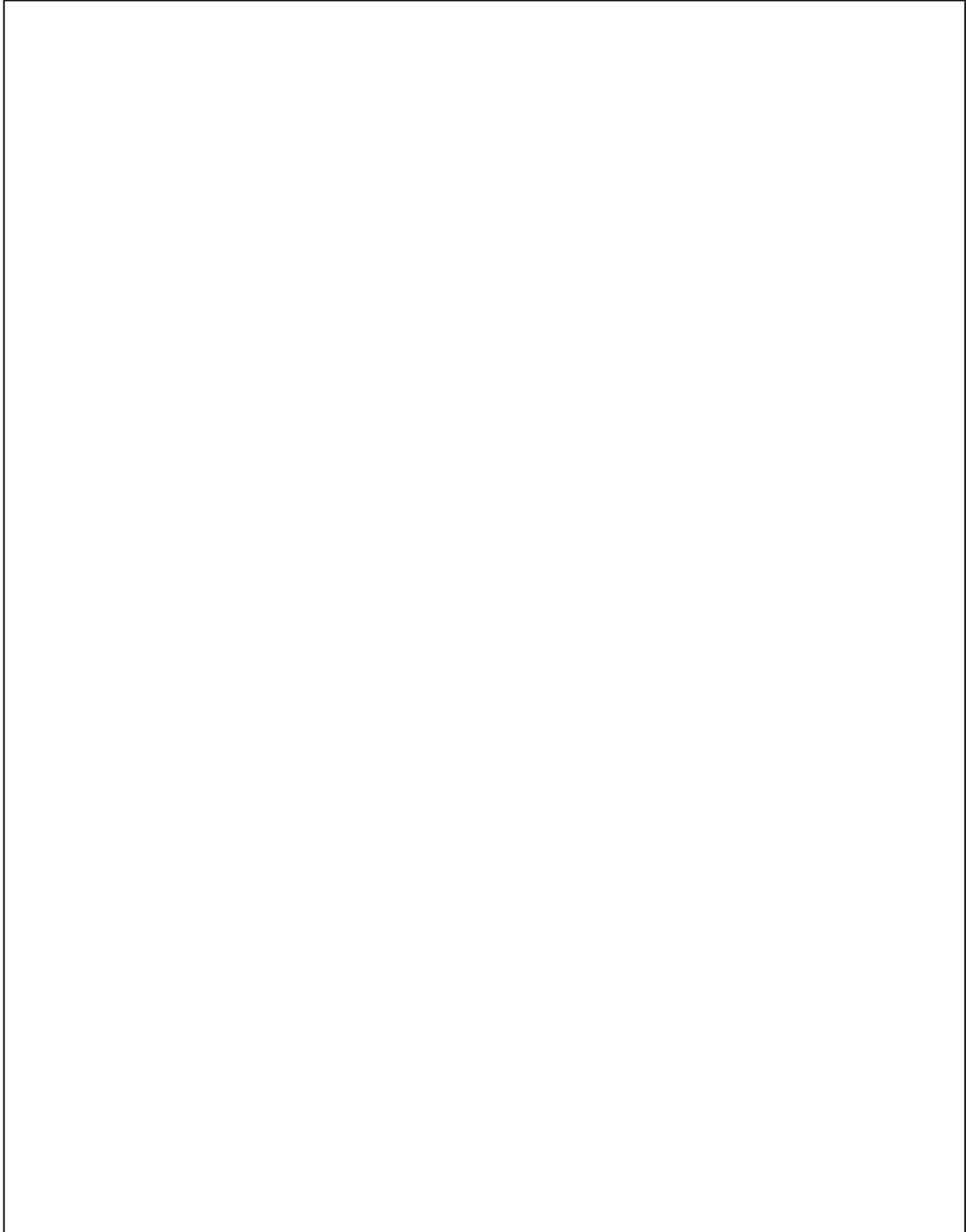

MAXI base units 867 mm



MAXI base units 867 mm

Base units

867 mm high

Unit without worktop and plinth, carcass depth 560 mm



		width		Price group													
				1	2	3	4	5	6	7	Servosoft	Pro Servosoft	ProServodglass	Soft closing Top Motion	Soft closing Top Motion Plus		
<p>Base unit 1 hinged door 2 adjustable shelves</p>		U	30	87	67	72	77	82	91	100	112	-	-	-	4	4	
		U	40	87	71	75	81	87	99	107	116	-	-	-	4	4	
		U	45	87	73	78	83	89	102	109	119	-	-	-	4	4	
		U	50	87	75	81	86	92	105	113	122	-	-	-	4	4	
		U	60	87	84	92	98	105	120	123	135	-	-	-	4	4	
<p>Base unit 1 hinged door 2 adjustable shelves <i>Plinth feet are supplied loose.</i></p>		U	30	87	33	72	77	82	87	96	105	117	-	-	-	4	4
		U	40	87	33	76	80	86	92	104	112	121	-	-	-	4	4
		U	45	87	33	78	83	88	94	107	114	124	-	-	-	4	4
		U	50	87	33	80	86	91	97	110	118	127	-	-	-	4	4
<p>Base unit 2 hinged doors 2 adjustable shelves</p>		U	80	87	128	144	155	168	192	209	230	-	-	-	8	8	
		U	90	87	134	150	161	172	198	217	239	-	-	-	8	8	
		U	100	87	142	152	163	176	204	224	250	-	-	-	8	8	
		U	100	87	142	152	163	176	204	224	250	-	-	-	8	8	
<p>Base unit 1 drawer 1 hinged door 2 adjustable shelves</p>		US	30	87	79	83	88	94	105	116	130	5	8	8	4	4	
		US	40	87	82	87	93	100	115	124	136	5	8	8	4	4	
		US	45	87	84	90	96	102	118	126	138	5	8	8	4	4	
		US	50	87	87	93	99	105	120	128	139	5	8	8	4	4	
		US	60	87	94	102	109	117	136	140	147	5	8	8	4	4	
<p>Base unit 3 deep drawers</p>		U3A	30	87	140	155	163	172	196	211	230	15	24	48	-	-	
		U3A	40	87	121	129	137	145	161	172	187	15	24	48	-	-	
		U3A	45	87	129	138	146	155	172	184	199	15	24	48	-	-	
		U3A	50	87	131	142	150	159	178	190	205	15	24	48	-	-	
		U3A	60	87	164	181	191	201	230	247	270	15	24	48	-	-	
		U3A	80	87	184	203	214	226	258	277	303	24	33	57	-	-	
		U3A	90	87	189	203	214	225	255	275	301	24	33	57	-	-	
		U3A	100	87	202	217	229	240	273	294	322	24	33	57	-	-	
<p>Base unit 1 drawer 2 deep drawers <i>Width can be shortened down to 300 mm</i></p>		US2A	50	87	129	140	148	158	178	190	207	15	24	40	-	-	
		US2A	60	87	132	146	154	162	185	199	218	15	24	48	-	-	
		US2A	80	87	181	195	205	216	245	264	290	21	30	54	-	-	
		US2A	90	87	184	198	209	220	249	269	295	21	30	54	-	-	
		US2A	100	87	200	214	226	238	268	288	315	21	30	46	-	-	
<p>Base unit 2 drawers 2 deep drawers</p>		U2S2A	30	87	158	173	182	191	218	234	256	20	32	48	-	-	
		U2S2A	40	87	160	171	180	191	211	225	242	26	38	54	-	-	
		U2S2A	45	87	162	173	182	193	213	227	246	26	38	54	-	-	
		U2S2A	50	87	166	179	189	199	222	237	256	26	38	54	-	-	
		U2S2A	60	87	170	186	196	206	235	252	275	20	32	48	-	-	
		U2S2A	80	87	206	225	238	250	285	305	333	26	38	54	-	-	
		U2S2A	90	87	215	230	242	254	287	309	338	26	38	54	-	-	
		U2S2A	100	87	226	242	254	267	302	325	355	26	38	54	-	-	

The anti-tilt device which is supplied automatically must be fitted for room divider versions.

Base units

867 mm high

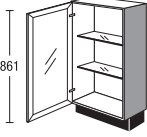
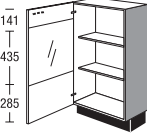
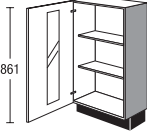
Unit without worktop and plinth, Carcase depth 326 mm

				width		Price group													
						1	2	3	4	5	6	7	Servosoft	Pro Servosoft	ProServoGlass	Soft closing Top Motion	Soft closing Top Motion Plus		
 <p>Framed glass door No. 701</p>	Base unit with glass door		326	UG	45	87	33	89	96	97	99	108	118	130	-	-	-	4	4
	1 glass door		326	UG	50	87	33	91	98	100	102	112	123	137	-	-	-	4	4
	2 adjustable glass shelves		326	UG	60	87	33	99	108	110	112	124	134	147	-	-	-	4	4
<p><i>Handles can only be mounted vertically on framed glass doors</i> <i>Handle can only be fitted horizontally on segment glass doors</i></p> <p><i>Assembly of handles nos. 740, 760, 780, 790 and 800 only horizontal, centred</i></p> <p><i>For available versions see overview Possible glass front versions</i></p> <p><i>For glass and frame finishes please refer to programme summary</i></p> <p><i>Plinth feet are supplied loose.</i></p>																			
 <p>Segmented glass door No. 706</p>																			
 <p>Framed glass door No. 704</p>																			
 <p>Glass door with glazing bars No. 705</p>																			

2.68 The anti-tilt device which is supplied automatically must be fitted for room divider versions.

Corner base units

867 mm high

Unit without worktop and plinth, carcass depth 560 mm

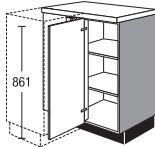
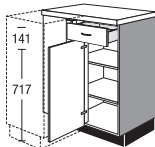
		width		Price group							Servosoft	Pro Servosoft	ProServdiglass	Soft closing Top Motion	Soft closing Top Motion Plus
				1	2	3	4	5	6	7					
 <p>Corner base unit with smooth mounting panel and loose panel 50 mm wide, in door colour for mounting base units 1 hinged door 2 adjustable shelves</p> <p><i>Planning dimension 1150 x 650 mm Carcass width 1000 mm</i></p> <p><i>May be pulled forward to balance dimensions. (minimum dimension: 1085 x 600 mm)</i></p> <p><i>The corner infill panel is supplied with returns for kitchens planned with adjacent dishwasher. Opening areas of appliances and drawers must be taken into account when planning smaller dimensions.</i></p> <p><i>An additional infill panel must be ordered for planning dimensions over 650 mm.</i></p> <p><i>Available for the following ranges: IP 1200, IP 2200, IP 3150, IP 4050</i></p>	UE	115	87	153	164	178	192	204	224	251	-	-	-	4	4
<p>Corner base unit same as above, but</p> <p><i>Planning dimension 1250 x 650 mm Carcass width 1000 mm</i></p> <p><i>May be pulled forward to balance dimensions. (minimum dimension: 1185 x 600 mm)</i></p>	UE	125	87	158	169	184	199	211	231	259	-	-	-	4	4
 <p>Corner base unit with smooth mounting panel and loose panel 50 mm wide, in door colour for mounting base units 1 drawer 1 hinged door 2 adjustable shelves</p> <p><i>Planning dimension 1150 x 650 mm Carcass width 1000 mm</i></p> <p><i>May be pulled forward to balance dimensions. (minimum dimension: 1085 x 600 mm)</i></p> <p><i>The corner infill panel is supplied with returns for kitchens planned with adjacent dishwasher. Opening areas of appliances and drawers must be taken into account when planning smaller dimensions.</i></p> <p><i>An additional infill panel must be ordered for planning dimensions over 650 mm.</i></p> <p><i>Available for the following ranges: IP 1200, IP 2200, IP 3150, IP 4050</i></p>	UES	115	87	172	183	197	212	223	243	270	5	8	8	4	4
<p>Corner base unit same as above, but</p> <p><i>Planning dimension 1250 x 650 mm Carcass width 1000 mm</i></p> <p><i>May be pulled forward to balance dimensions. (minimum dimension: 1185 x 600 mm)</i></p>	UES	125	87	177	188	203	218	229	251	278	5	8	8	4	4





The anti-tilt device which is supplied automatically must be fitted for room divider versions.

2.69

Corner base units

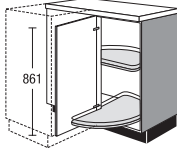
867 mm high

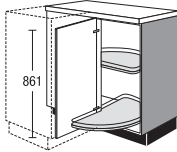
Unit without worktop and plinth, carcass depth 560 mm

		width	Price group							Servosoft	Pro Servosoft	ProServoGlass	Soft closing Top Motion	Soft closing Top Motion Plus			
			1	2	3	4	5	6	7								
 <p>Corner base unit with smooth add-on panel, 500 mm, and loose infill panel, in door colour finish for adding base units 1 hinged door 2 wooden carousel shelves with metal rail</p> <p><i>Planning dimension 1150 x 650 mm Carcass width 1000 mm</i></p> <p><i>May be pulled forward to balance dimensions. (minimum dimension: 1085 x 600 mm)</i></p> <p><i>Opening areas of appliances and drawers must be taken into account when planning smaller dimensions.</i></p> <p><i>An additional infill panel must be ordered for planning dimensions over 650 mm.</i></p> <p><i>Order hinged door opening limited Z19 separately if required.</i></p> <p><i>Available for the following ranges: IP 1200, IP 2200, IP 3150, IP 4050</i></p>	Version L	UE	115	87	KP	183	196	206	216	233	251	276	-	-	-	4	4
																	
 <p>Corner base unit same as above, but 2 laminate swing-out shelves</p>		UE	115	87	K	136	149	159	169	186	204	227	-	-	-	4	4
																	

2.70 The anti-tilt device which is supplied automatically must be fitted for room divider versions.

Corner base units

867 mm high

Unit without worktop and plinth, carcass depth 560 mm

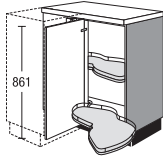
				Price group														
				width	1	2	3	4	5	6	7	Servosoft	Pro Servosoft	ProServoglass	Soft closing Top Motion	Soft closing Top Motion Plus		
 <p>Version L</p> <p>Corner base unit with smooth built-in panel and loose infill panel 50 mm wide in door finish or door colour for adding on base units 1 hinged door 2 fully pivotable wooden carousel shelves with LeMans metal rail with self-closing mechanism and cushioning effect</p> <p><i>Planning dimension 1150 x 650 mm Not to fall below planning dimension 1150 mm. (carcase width 1000 mm)</i></p> <p><i>May be pulled forward to balance dimensions. (minimum dimensions: 1150 x 600 mm)</i></p> <p><i>When planning kitchens with a dishwasher next to the corner unit, the corner trim is supplied with return.</i></p> <p><i>An additional infill panel must be ordered for planning dimensions over 650 mm.</i></p> <p><i>The hinged doors must open to an angle of at least 90° (observe handle spacing).</i></p> <p><i>Available for the following ranges: IP 1200, IP 2200, IP 3150, IP 4050</i></p>	Corner base unit	UE	115	87	LMP	347	359	367	376	391	406	436	-	-	-	4	4	
		with 50 cm door																
	Corner base unit	UE	115	87	LM	321	333	343	350	365	381	410	-	-	-	4	4	
	same as above, but 2 fully pivotable wooden carousel shelves with LeMans metal rail																	

The anti-tilt device which is supplied automatically must be fitted for room divider versions.

Corner base units

867 mm high

Unit without worktop and plinth, carcass depth 560 mm

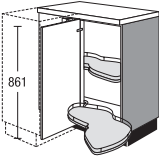
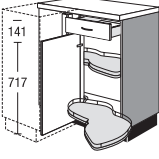
		width	Price group							Servosoft	Pro Servosoft	ProServoGlass	Soft closing Top Motion	Soft closing Top Motion Plus			
			1	2	3	4	5	6	7								
 <p>Version L</p>	<p>Corner base unit with smooth built-in panel and loose infill panel 50 mm wide in door finish or door colour for adding on base units 1 hinged door 2 fully pivotable wooden carousel shelves with LeMans metal rail with self-closing mechanism and cushioning effect</p> <p><i>Planning dimension 1250 x 650 mm Not to fall below planning dimension 1250 mm. (carcase width 1000 mm)</i></p> <p><i>May be pulled forward to balance dimensions. (minimum dimensions: 1250 x 600 mm)</i></p> <p><i>When planning kitchens with a dishwasher next to the corner unit, the corner trim is supplied with return.</i></p> <p><i>An additional infill panel must be ordered for planning dimensions over 650 mm.</i></p> <p><i>The hinged doors must open to an angle of at least 90° (observe handle spacing).</i></p> <p><i>Available for the following ranges: IP 1200, IP 2200, IP 3150, IP 4050</i></p>	UE	125	87	LMP	356	368	377	386	401	417	448	-	-	-	4	4
	<p>Corner base unit same as above, but 2 fully pivotable wooden carousel shelves with LeMans metal rail</p>	UE	125	87	LM	330	342	351	360	375	392	422	-	-	-	4	4
 <p>Version L</p>	<p>Corner base unit with smooth built-in panel and loose infill panel 50 mm wide in door finish or door colour for adding on base units 1 drawer 1 hinged door 2 fully pivotable wooden carousel shelves with LeMans metal rail with self-closing mechanism and cushioning effect</p> <p><i>Planning dimension 1150 x 650 mm Not to fall below planning dimension 1150 mm. (carcase width 1000 mm)</i></p> <p><i>May be pulled forward to balance dimensions. (minimum dimensions: 1150 x 600 mm)</i></p> <p><i>When planning kitchens with a dishwasher next to the corner unit, the corner trim is supplied with return.</i></p> <p><i>An additional infill panel must be ordered for planning dimensions over 650 mm.</i></p> <p><i>The hinged doors must open to an angle of at least 90° (observe handle spacing).</i></p> <p><i>Available for the following ranges: IP 1200, IP 2200, IP 3150, IP 4050</i></p>	UES	115	87	LMP	361	373	381	390	404	421	451	5	8	8	4	4
	<p>Corner base unit same as above, but 2 fully pivotable wooden carousel shelves with LeMans metal rail</p>	UES	115	87	LM	335	347	355	364	379	396	424	5	8	8	4	4

2.72 The anti-tilt device which is supplied automatically must be fitted for room divider versions.

Corner base units, Diagonal angled base units

867 mm high

Unit without worktop and plinth, carcass depth 560 mm

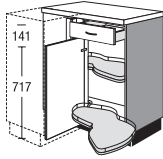
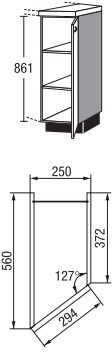
		width		Price group											
				1	2	3	4	5	6	7	Servosoft	Pro Servosoft	ProServoglass	Soft closing Top Motion	Soft closing Top Motion Plus
 <p>Version L</p> <p>Corner base unit with smooth built-in panel and loose infill panel 50 mm wide in door finish or door colour for adding on base units 1 drawer 1 hinged door 2 fully pivotable wooden carousel shelves with LeMans metal rail with self-closing mechanism and cushioning effect</p> <p><i>Planning dimension 1250 x 650 mm Not to fall below planning dimension 1250 mm. (carcase width 1000 mm)</i></p> <p><i>May be pulled forward to balance dimensions. (minimum dimensions: 1250 x 600 mm)</i></p> <p><i>When planning kitchens with a dishwasher next to the corner unit, the corner trim is supplied with return.</i></p> <p><i>An additional infill panel must be ordered for planning dimensions over 650 mm.</i></p> <p><i>The hinged doors must open to an angle of at least 90° (observe handle spacing).</i></p> <p><i>Available for the following ranges: IP 1200, IP 2200, IP 3150, IP 4050</i></p>	<p>Corner base unit UES 125 87 LMP with 60 cm door</p>	371	383	392	401	415	433	463	5	8	8	4	4		
	<p>Corner base unit UES 125 87 LM same as above, but 2 fully pivotable wooden carousel shelves with LeMans metal rail</p>	345	357	366	375	390	408	436	5	8	8	4	4		
 <p>3-D base unit 560/372 mm deep 1 hinged door 2 adjustable shelves</p> <p><i>Measurements with worktop 290 mm Measurements with modular panel 275 mm</i></p> <p><i>The delivery comprises several packages.</i></p>	<p>UV 25 87 with 30 cm door</p>	103	107	111	115	122	129	140	-	-	-	4	4		

The anti-tilt device which is supplied automatically must be fitted for room divider versions.

Base units for appliances

867 mm high

Unit without worktop and plinth, carcass depth 560 mm

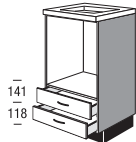
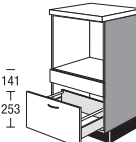
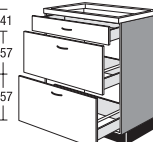
		width	Price group							Servosoft	Pro Servosoft	ProServoGlass	Soft closing Top Motion	Soft closing Top Motion Plus
			1	2	3	4	5	6	7					
<p>Information for plans with standalone hobs</p> <p>For orders that contain a hob we are obliged, for product liability reasons, to confirm and deliver a hob base unit with the appropriate heat resistant panel. Cancellation/amendment is not possible.</p> <p>For appliances from a third-party (hob not provided by us), we urgently require written confirmation that a unit with a heat resistant panel is not desired or required.</p> <p>You will find the appliance heights of the hobs in our range in the Sales manual appliances under the respective item.</p> <p>Depending on the particular appliance (installation height) and worktop depth, a drawer with a low frame may be provided.</p>														
 <p>Base unit for built-in appliances</p> <p>Aperture dimensions: 599 mm high, max. 568 mm wide, 560 mm deep</p> <p>2 drawers</p> <p><i>Please state worktop thickness</i></p> <p><i>During planning and installation, it is essential to observe the safety distances of the electrical appliance manufacturer!</i></p>	UH2S	87	102	109	116	123	142	147	154	10	16	16	-	-
 <p>Base unit for built-in appliances</p> <p>Aperture dimensions: 448 mm high, max. 568 mm wide, 560 mm deep</p> <p>1 fixed front panel 1 deep drawer</p> <p><i>Specify appliance type</i></p> <p><i>During planning and installation, it is essential to observe the safety distances of the electrical appliance manufacturer!</i></p>	UMA	87	111	119	124	130	144	150	158	5	8	16	-	-
 <p>Hob base unit</p> <p>1 drawer 2 deep drawers</p> <p><i>Specify appliance type</i></p> <p><i>Please state worktop thickness</i></p> <p><i>40 mm clearance to bottom edge of worktop.</i></p> <p><i>During planning and installation, it is essential to observe the safety distances of the electrical appliance manufacturer!</i></p>	KIS2A KIS2A KIS2A KIS2A	60 80 90 100	87 87 87 87	166 211 217 229	180 224 230 242	187 234 240 252	195 245 251 262	221 272 280 291	234 291 298 310	255 317 324 336	15 21 21 21	24 30 30 30	40 46 46 46	- - - -

2.74 The anti-tilt device which is supplied automatically must be fitted for room divider versions.

Base units for appliances

867 mm high

Unit without worktop and plinth, carcass depth 560 mm

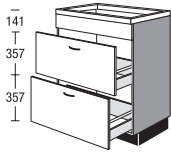
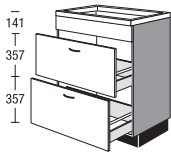
		width		Price group												
				1	2	3	4	5	6	7	Servosoft	Pro Servosoft	ProServoglass	Soft closing Top Motion	Soft closing Top Motion Plus	
 <p>Hob base unit for hob extractor</p> <p>1 fixed front panel 2 deep drawers (reduced in depth depending on appliance)</p> <p><i>Specify appliance type</i></p> <p><i>Please state worktop thickness</i></p> <p><i>Depending on appliance, an adjustment must be made on site.</i></p> <p><i>We cannot accept responsibility for swelling damage due to circulating air mode.</i></p> <p><i>During planning and installation, it is essential to observe the safety distances of the electrical appliance manufacturer!</i></p>	KDB2A	80	87	183	196	206	216	244	263	287	16	22	38	-	-	
	KDB2A	90	87	188	201	212	223	251	270	295	16	22	38	-	-	
	KDB2A	100	87	193	206	218	229	258	277	303	16	22	38	-	-	
 <p>Hob base unit for hob extractor</p> <p>1 fixed front panel 2 deep drawers</p> <p><i>Specify appliance type</i></p> <p><i>Please state worktop thickness</i></p> <p><i>Depending on appliance, an adjustment must be made on site.</i></p> <p><i>We cannot accept responsibility for swelling damage due to circulating air mode.</i></p> <p><i>During planning and installation, it is essential to observe the safety distances of the electrical appliance manufacturer!</i></p> <p><i>Appliance must be suitable for non-ducted recirculating air.</i></p>	KDB2A	80	87	U	183	196	206	216	244	263	287	16	22	38	-	-
	KDB2A	90	87	U	188	201	212	223	251	270	295	16	22	38	-	-
	KDB2A	100	87	U	193	206	218	229	258	277	303	16	22	38	-	-

The anti-tilt device which is supplied automatically must be fitted for room divider versions.

2.75

Base units for appliances

867 mm high

Unit without worktop and plinth, carcass depth 560 mm

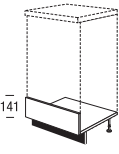
		width	Price group							Servosoft	Pro Servosoft	ProServoGlass	Soft closing Top Motion	Soft closing Top Motion Plus	
			1	2	3	4	5	6	7						
 <p>III. shows FB xx 14 GS</p>	Plinth base with plinth feet for dishwasher	SOP	45	1	30	30	30	30	30	30	30	-	-	-	-
	SOP	60	1	32	32	32	32	32	32	32	32	-	-	-	-
	<p><i>Please check whether dishwasher is approved for raised installation.</i></p> <p><i>Can only be planned with dishwasher with 100 mm plinth.</i></p> <p><i>Please order front panel for dishwasher separately.</i></p> <p><i>Cannot be combined with XXL/high-volume dishwasher.</i></p>														
	Fixed front panel on plinth platform Front height: 141 mm	FB	45	14	GS	27	28	30	32	33	34	38	-	-	-
	<p><i>Max. appliance height 842 mm</i></p> <p><i>Not available for the following ranges: IP 4820, IP 7500</i></p>	FB	60	14	GS	28	29	31	33	34	36	40	-	-	-
	Fixed front panel on plinth platform For installing dishwashers Door height: 173 mm	FB	60	17	GS	30	31	34	36	38	40	44	-	-	-
	<p><i>Max. appliance height 868 mm</i></p> <p><i>Not available for the following ranges: IP 4820, IP 7500</i></p>														
	Plinth platform without plinth feet for dishwasher	SOP	60			31	31	31	31	31	31	31	-	-	-
	<p><i>Only plan dishwasher with 10 cm plinth.</i></p> <p><i>Order front panel for dishwasher separately</i></p> <p><i>Cannot be combined with XXL/high-volume dishwasher.</i></p> <p><i>Please check whether dishwasher is approved for raised installation.</i></p>														

2.76 The anti-tilt device which is supplied automatically must be fitted for room divider versions.

Base units for appliances

867 mm high

Unit without worktop and plinth, carcass depth 560 mm

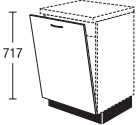
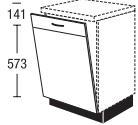
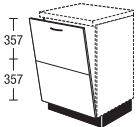
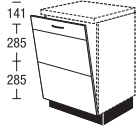
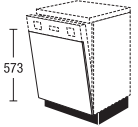
				Price group											
		width		1	2	3	4	5	6	7	Servosoft	Pro Servosoft	ProServoglass	Soft closing Top Motion	Soft closing Top Motion Plus
 <p>Vapour guard above dishwashers 90 mm deep, 1.5 mm thick</p>	ZV 449 stainless steel-effect			3	3	3	3	3	3	3	-	-	-	-	-
	ZV 599 stainless steel-effect			3	3	3	3	3	3	3	-	-	-	-	-
 <p>Front panel for fully integrated built-under dishwashers <i>Specify appliance type</i></p>	TGV	45		22	25	27	30	37	41	46	-	-	-	-	-
	TGV	60		24	28	30	33	39	45	54	-	-	-	-	-
 <p>Front panel for fully integrated built-under dishwashers with pinned front <i>Not available for the following ranges: IP 4820, IP 7500</i> <i>Specify appliance type</i> <i>Top grip ledge on upper part of front</i></p>	TGV	45	MS	29	32	34	37	44	48	54	-	-	-	-	-
	TGV	60	MS	31	35	37	40	46	52	61	-	-	-	-	-
 <p>Front panel for fully integrated built-under dishwashers with pinned front <i>Specify appliance type</i> <i>Top grip ledge on upper part of front</i> <i>Not available for the following ranges: IP 4820, IP 7500</i></p>	TGV		60	M2	32	36	38	41	47	53	62	-	-	-	-
 <p>Front panel for fully integrated built-under dishwashers with pinned front <i>Specify appliance type</i> <i>Not available for the following ranges: IP 4820, IP 7500</i> <i>Top grip ledge on upper part of front</i></p>	TGV	45	M3	33	36	38	41	48	55	64	-	-	-	-	-
	TGV	60	M3	37	39	42	44	50	58	68	-	-	-	-	-
 <p>Front panel For semi-integrated built-under dishwashers <i>Specify appliance type</i> <i>Front component in ranges IP 4820 and IP 7500 with recessed grip.</i></p>	TG	45		17	20	22	24	30	35	41	-	-	-	-	-
	TG	60		20	23	25	27	34	40	48	-	-	-	-	-

The anti-tilt device which is supplied automatically must be fitted for room divider versions.

Sink base units

867 mm high

Unit without worktop and plinth, carcass depth 560 mm

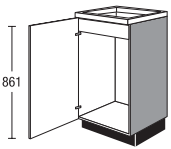
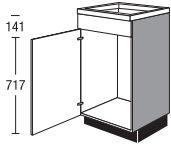
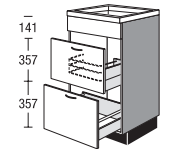
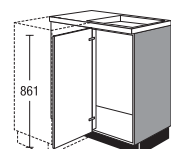
		width	Price group							Servosoft	Pro Servosoft	ProServoGlass	Soft closing Top Motion	Soft closing Top Motion Plus	
			1	2	3	4	5	6	7						
 <p>Sink base unit 1 hinged door 1 fixed inside panel</p>	SP	45	87	72	77	81	85	90	97	107	-	-	-	4	4
	SP	50	87	74	79	83	88	96	104	114	-	-	-	4	4
	SP	60	87	77	84	90	97	113	118	124	-	-	-	4	4
 <p>Sink base unit 1 fixed front panel 1 hinged door</p>	SPB	40	87	67	71	74	78	81	87	96	-	-	-	4	4
	SPB	45	87	68	73	77	81	86	93	102	-	-	-	4	4
	SPB	50	87	70	75	79	84	92	100	110	-	-	-	4	4
	SPB	60	87	73	80	86	93	109	114	120	-	-	-	4	4
 <p>Sink base unit 1 fixed front panel 2 deep drawers top deep drawer with central cutout for drain approx. 580 mm wide, approx. 325 mm deep</p> <p>B → 600 mm → X = 300 mm B → 800 mm → X = 500 mm B → 900 mm → X = 600 mm B → 1000 mm → X = 700 mm B → 1200 mm → X = 900 mm</p>	SPB2A	60	87	172	184	194	204	230	247	270	10	16	32	-	-
	SPB2A	80	87	193	205	215	224	250	267	291	16	22	38	-	-
	SPB2A	90	87	204	216	225	235	261	278	302	16	22	38	-	-
	SPB2A	100	87	215	227	236	246	272	289	313	16	22	38	-	-
 <p>Corner sink base unit with smooth mounting panel and loose panel 50 mm wide, in door colour for mounting base units 1 hinged door</p> <p>Planning dimension 1150 x 650 mm Carcass width 1000 mm</p> <p>May be pulled forward to balance dimensions. (minimum dimension: 1085 x 600 mm)</p> <p>Installation of the waste bin ZAT 40 is not possible.</p> <p>The corner infill panel is supplied with returns for kitchens planned with adjacent dishwasher.</p> <p>An additional infill panel must be ordered for planning dimensions over 650 mm.</p> <p>Available for the following ranges: IP 1200, IP 2200, IP 3150, IP 4050</p>	SPE	115	87	121	131	139	147	161	176	196	-	-	-	4	4
<p>Corner sink base unit same as above, but</p> <p>Planning dimension 1250 x 650 mm Carcass width 1000 mm</p> <p>May be pulled forward to balance dimensions. (minimum dimension: 1185 x 600 mm)</p> <p>Cannot be combined with drip insert EZIT...A.</p>	SPE	125	87	133	145	154	165	186	198	214	-	-	-	4	4

2.78 The anti-tilt device which is supplied automatically must be fitted for room divider versions.

Shelf units

867 mm high

Unit without worktop and plinth, carcass depth 560 mm

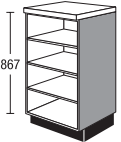
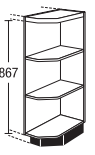
		width		Price group							Servosoft	Pro Servosoft	ProServoGlass	Soft closing Top Motion	Soft closing Top Motion Plus
				1	2	3	4	5	6	7					
 <p>Base shelf unit 3 adjustable shelves <i>Finish in carcass material</i> <i>Please indicate desired width (150-600 mm).</i> <i>Not available in visible side colours.</i></p>	UR	V	87	123	123	123	123	123	123	123	-	-	-	-	-
 <p>Shelf end unit, angled 2 fixed shelves <i>Finish in carcass material</i> <i>Measurements with worktop 290 mm</i> <i>Measurements with modular panel 275 mm</i> <i>Not available in visible side colours.</i></p>	URA	25	87	S	87	87	87	87	87	87	-	-	-	-	-

The anti-tilt device which is supplied automatically must be fitted for room divider versions.

2.79

Shelf units

867 mm high

Unit without worktop and plinth, Carcase depth 326 mm

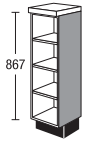
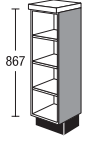
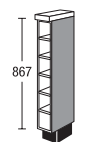
	UR	width	Price group							Servosoft	Pro Servosoft	ProServoGlass	Soft closing Top Motion	Soft closing Top Motion Plus	
			1	2	3	4	5	6	7						
 <p>Base shelf unit 3 adjustable shelves <i>Finish in carcase material</i></p>	UR	30	87	33	76	76	76	76	76	76	76	-	-	-	-
 <p>Base shelf unit 3 adjustable shelves <i>Please indicate desired width (150-300 mm).</i> <i>Finish in carcase material</i></p>	UR	V	87	33	87	87	87	87	87	87	87	-	-	-	-
 <p>Open shelf unit for bottles 6 compartments for bottles 5 fixed shelves <i>Finish in carcase material</i></p>	UR	15	87	33F	81	81	81	81	81	81	81	-	-	-	-

2.80 The anti-tilt device which is supplied automatically must be fitted for room divider versions.

Filler panels

867 mm high

Unit without worktop and plinth.

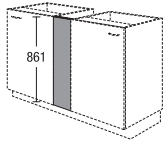
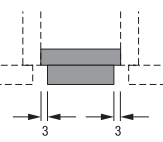
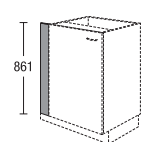
				Price group												
				width	1	2	3	4	5	6	7	Servosoft	Pro Servosoft	ProServoglass	Soft closing Top Motion	Soft closing Top Motion Plus
 <p>Infill panel for base units without plinth, 867 mm high Fitted between base units</p> <p><i>Finish in door material with straight edge on both sides</i></p> <p><i>Some front edges in colour of carcass.</i></p> <p><i>Not available in visible side colours.</i></p>	UPF	10	87 Z	17	20	21	23	24	25	28	-	-	-	-	-	
	UPF	20	87 Z	20	23	24	25	26	29	33	-	-	-	-	-	
 <p>Infill panel for base units without plinth, 867 mm high Fitted between wall and carcass side</p> <p><i>Finish in door material without edging on the wall side</i></p> <p><i>Some front edges in colour of carcass.</i></p> <p><i>Not available in visible side colours.</i></p> <p><i>Due to the installation angle, the maximum possible on-site width reduction is 46 mm.</i></p>	UPF	10	87	17	20	21	23	24	25	28	-	-	-	-	-	
	UPF	20	87	21	25	26	27	29	31	34	-	-	-	-	-	
 <p>Infill panel for base units without plinth, 867 mm high</p> <p><i>Finish in carcass material</i></p> <p><i>Not available in visible side colours.</i></p>	UPK	10	87	12	12	12	12	12	12	12	-	-	-	-	-	
	UPK	20	87	15	15	15	15	15	15	15	-	-	-	-	-	
	UPK	30	87	19	19	19	19	19	19	19	-	-	-	-	-	

The anti-tilt device which is supplied automatically must be fitted for room divider versions.

Filler panels

867 mm high

Unit without worktop and plinth.

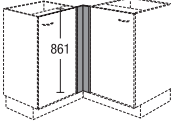
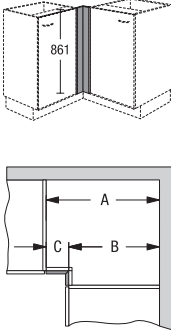
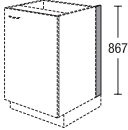
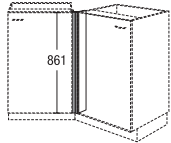
		width	Price group							Servosoft	Pro Servosoft	ProServoGlass	Soft closing Top Motion	Soft closing Top Motion Plus	
			1	2	3	4	5	6	7						
 <p>Corner infill panel for base units without plinth, 867 mm high <i>Finish in carcass material for corner 600 x 600 mm</i> <i>With adjoining units with drawers/pull-outs, check the clearance for opening.</i> <i>Not available in visible side colours.</i></p>	UPEK	60	87	14	14	14	14	14	14	14	-	-	-	-	
	UPEF	65	87	27	31	32	34	35	38	42	-	-	-	-	
	UPEF	65	87	GS	27	31	32	34	35	38	42	-	-	-	-
 <p>Corner infill panel for base units without plinth, 867 mm high <i>Finish in door material</i> <i>Dimensions given are from one carcass corner to another</i> <i>Side dimensions of less than 60 mm width are manufactured from carcass material</i> <i>Not available in visible side colours.</i></p> <p>Panel size in mm: A-B=C</p>	UPEF	76	87	V	31	35	37	39	42	45	50	-	-	-	-
	UPEF	76	87	V	31	35	37	39	42	45	50	-	-	-	-
 <p>Infill panel base-unit side without plinth, 867 mm high for wall end <i>Finish in carcass material</i> <i>for deeper tops, order plinth SO 151 separately</i> <i>Not available in visible side colours.</i></p>	UPT	10	87	13	13	13	13	13	13	13	-	-	-	-	
	UPT	20	87	15	15	15	15	15	15	15	-	-	-	-	
	UPT	30	87	18	18	18	18	18	18	18	-	-	-	-	
 <p>Corner infill panel for 135° base unit corner installations without plinth, 867 mm high <i>can be used on both sides</i> <i>Finish in door material</i> <i>Not available in visible side colours.</i></p>	UPEF135		87	33	38	39	42	43	46	51	-	-	-	-	

2.82

The anti-tilt device which is supplied automatically must be fitted for room divider versions.



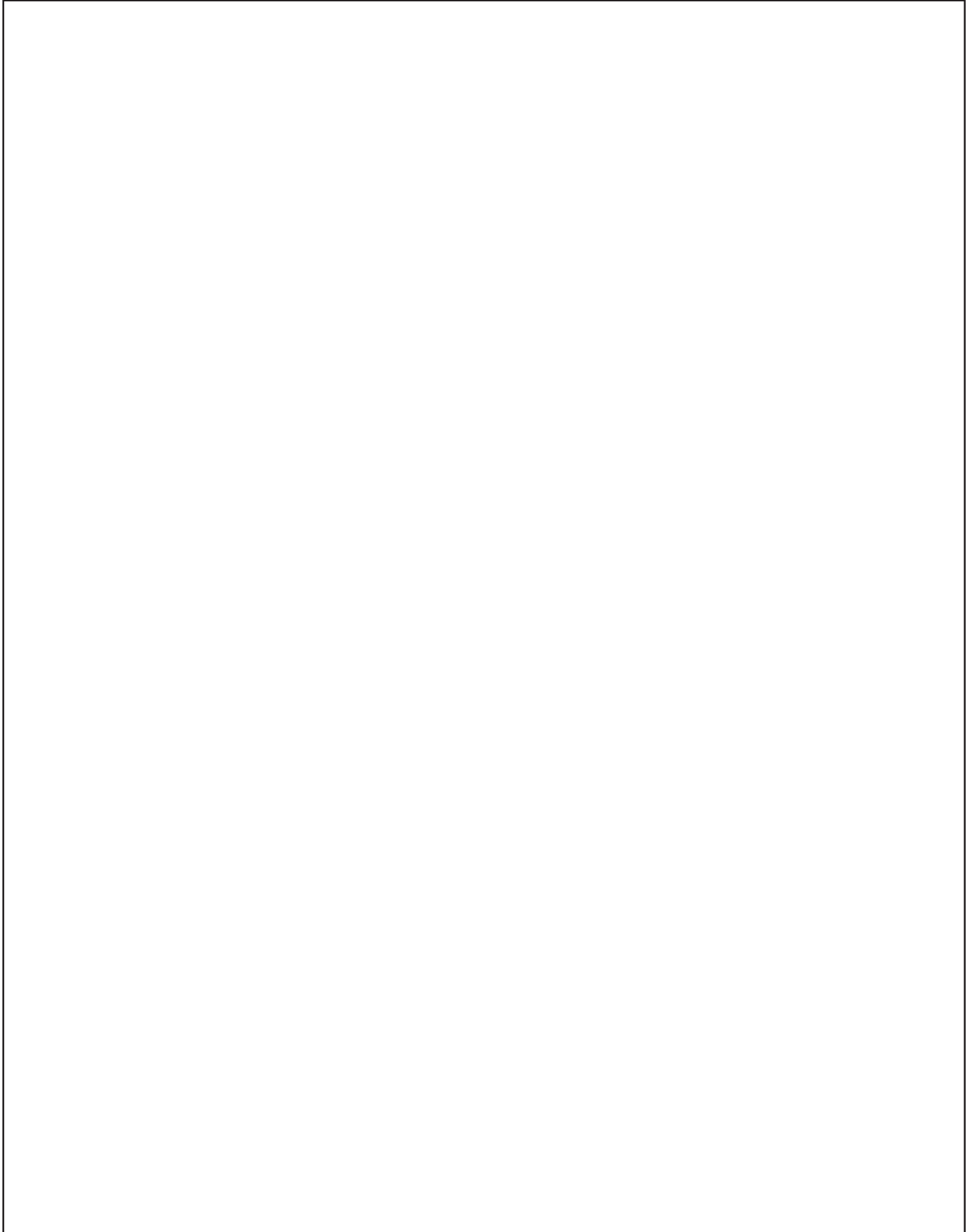

Base unit interior equipment

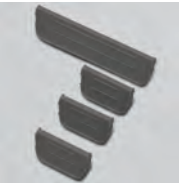

Base unit interior
equipment

Base unit interior
equipment





Scoop cutlery inserts

		width		Item	universal
 <p>Cutlery insert Scoop Anthracite 474 mm deep for 560 mm deep units</p> <p>To unit width 60 cm: Including 3 narrow and 1 wide lengthwise dividers, flexible use.</p> <p>From unit width 80 cm: Including 6 narrow and 2 wide lengthwise dividers, flexible use.</p> <p><i>Suitable for drawers 508, 510 and 512</i></p>	300 mm unit width	221	ZB 301 AN	5	
	400 mm unit width	321	ZB 401 AN	5	
	450 mm unit width	371	ZB 451 AN	6	
	500 mm unit width	421	ZB 501 AN	6	
	600 mm unit width	521	ZB 601 AN	7	
	800 mm unit width	721	ZB 801 AN	9	
	900 mm unit width	821	ZB 901 AN	9	
	1000 mm unit width	921	ZB 1001 AN	10	
	1200 mm unit width	1121	ZB 1201 AN	11	
	 <p>Longitudinal divider Scoop Finish laminate anthracite Set consisting of: 3 narrow and 1 wide lengthwise dividers</p>			ZBZ 7 AN	2
 <p>Cutlery insert Scoop Anthracite 373 mm deep for 460 mm deep units</p> <p>To unit width 60 cm: Including 3 narrow and 1 wide lengthwise dividers, flexible use.</p> <p>from 800 mm unit width Including 6 narrow and 2 wide lengthwise dividers, flexible use.</p>	500 mm unit width	421	ZB 501 AN40	7	
	600 mm unit width	521	ZB 601 AN40	8	
	800 mm unit width	721	ZB 801 AN40	10	
	900 mm unit width	821	ZB 901 AN40	10	
	1000 mm unit width	921	ZB 1001 AN40	11	
	1200 mm unit width	1121	ZB 1201 AN40	12	
 <p>Spice jar holder Scoop for 12 jars Cutout Ø 58 mm plastic stainless steel-effect</p> <p><i>For 60 cm unit widths or greater.</i></p> <p><i>Also suitable in combination with Scoop cutlery insert in a depth of 373 mm.</i></p>			ZBZGE	3	
 <p>Set of spice jars Suitable spice jar holders</p> <p><i>Spices: Tomato seasoning salt, nutmeg, basil, garlic, curry, dill tips, steak seasoning, cumin, cinnamon, pepper, sweet pepper, chicken seasoning salt</i></p>	12 jars		ZI 12	6	
 <p>Knife block Scoop for 6 knives plastic stainless steel-effect</p> <p><i>For 50 cm unit width or greater.</i></p> <p><i>Also suitable in combination with Scoop cutlery insert in a depth of 373 mm.</i></p>			ZBZME	3	

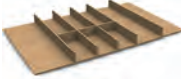

Synthetic cutlery inserts

				Item	
			width		universal
 <p>Cutlery insert silver-grey 474 mm deep for 560 mm deep units <i>Matches drawer finish 506</i></p> <p>ill. shows example of division from 600 mm wide</p>  <p>ill. shows example of division from 900 mm wide</p>	300 mm unit width	221	ZB 30 SG	4	
	400 mm unit width	321	ZB 40 SG	4	
	450 mm unit width	371	ZB 45 SG	5	
	500 mm unit width	421	ZB 50 SG	5	
	600 mm unit width	521	ZB 60 SG	6	
	800 mm unit width	721	ZB 80 SG	7	
	900 mm unit width	821	ZB 90 SG	7	
	1000 mm unit width	921	ZB 100 SG	8	
	1200 mm unit width	1121	ZB 120 SG	9	
 <p>Cutlery insert for drawers with a low frame silver-grey for drawers under induction hobs and units with low frame 47 mm high, 474 mm deep, for 560 mm deep units <i>Matches drawer finish 506</i></p> <p>ill. shows example of division from 600 mm wide</p>	600 mm unit width	521	ZBI 601 SG	6	
	800 mm unit width	721	ZBI 801 SG	7	
	900 mm unit width	821	ZBI 901 SG	7	
	1000 mm unit width	921	ZBI 1001 SG	8	
	1200 mm unit width	1121	ZBI 1201 SG	9	
 <p>Cutlery insert for drawers with a low frame Anthracite for drawers under induction hobs and units with low frame 47 mm high, 474 mm deep, for 560 mm deep units <i>Suitable for drawers 508, 510 and 512</i></p> <p>ill. shows example of division from 600 mm wide</p>	600 mm unit width	521	ZBI 601 AN	6	
	800 mm unit width	721	ZBI 801 AN	7	
	900 mm unit width	821	ZBI 901 AN	7	
	1000 mm unit width	921	ZBI 1001 AN	8	
	1200 mm unit width	1121	ZBI 1201 AN	9	

Wooden cutlery inserts

		width		Item	universal
 <p>Cutlery insert natural oak 472 mm deep part solid for 560 mm deep units</p> <p>Ill. shows 90 cm width</p>	300 mm unit width	206	ZB 302 EN	9	
	400 mm unit width	306	ZB 402 EN	11	
	450 mm unit width	356	ZB 452 EN	15	
	500 mm unit width	406	ZB 502 EN	15	
	600 mm unit width	506	ZB 602 EN	19	
	800 mm unit width	706	ZB 802 EN	22	
	900 mm unit width	806	ZB 902 EN	25	
	1000 mm unit width	906	ZB 1002 EN	28	
	1200 mm unit width	1106	ZB 1202 EN	31	
 <p>Knife block natural oak Dimensions (H x W x D): 39 x 149 x 472 mm for 560 mm deep units part solid</p> <p><i>Can be used from unit width 60 cm. Not suitable for Induktion cutlery inserts.</i></p>			ZBZ 22 EN	11	
 <p>Angled shelf in natural oak part solid Dimensions (H x W x D): 20 x 149 x 472 mm for 560 mm deep units 3-piece profile in anodised aluminium</p> <p><i>Can be used from unit width 60 cm. Not suitable for Induktion cutlery inserts.</i></p>			ZBZ 32 EN	17	
 <p>Induktion cutlery insert natural oak part solid for drawers under induction hobs and units with low frame 47 mm high, 472 mm deep, for 560 mm deep units</p> <p>Ill. shows 90 cm width</p>	600 mm unit width	506	ZBI 602 EN	20	
	800 mm unit width	706	ZBI 802 EN	24	
	900 mm unit width	806	ZBI 902 EN	27	
	1000 mm unit width	906	ZBI 1002 EN	29	
	1200 mm unit width	1106	ZBI 1202 EN	32	



Pull-out organisers

				Item	
			width		universal
 <p>ORGA-LINE division Divider Anthracite incl. holder <i>Order lengthwise dividers separately.</i> <i>Can be combined with TANDEMBOX antaro.</i> <i>Suitable for drawers 508, 510 and 512</i></p>	30 cm deep drawer width	177	ZOLT 30	5	
	40 cm deep drawer width	277	ZOLT 40	6	
	45 cm deep drawer width	327	ZOLT 45	6	
	50 cm deep drawer width	377	ZOLT 50	7	
	60 cm deep drawer width	477	ZOLT 60	7	
	80 cm deep drawer width	677	ZOLT 80	8	
	90 cm deep drawer width	777	ZOLT 90	9	
	100 cm deep drawer width	877	ZOLT 100	9	
	120 cm deep drawer width	1077	ZOLT 120	10	
	<p>ORGA-LINE division Longitudinal divider Anthracite 1 each</p>			ZOLT L	2
 <p>ORGA-LINE division Horizontal railing Anthracite incl. holder <i>Order lengthwise dividers separately.</i> <i>Can be combined with TANDEMBOX antaro.</i> <i>Suitable for drawers 508, 510 and 512</i></p>	30 cm deep drawer width	177	ZOLR 30	4	
	40 cm deep drawer width	277	ZOLR 40	4	
	45 cm deep drawer width	327	ZOLR 45	4	
	50 cm deep drawer width	377	ZOLR 50	5	
	60 cm deep drawer width	477	ZOLR 60	5	
	80 cm deep drawer width	677	ZOLR 80	6	
	90 cm deep drawer width	777	ZOLR 90	7	
	100 cm deep drawer width	877	ZOLR 100	7	
<p>ORGA-LINE division Lengthwise dividers for cross rail Anthracite 1 each</p>			ZOLRL	1	







Mats

				Item	universal
				width	
 <p>Mat silver-grey for deep drawers and drawers 474 mm deep Grooved anti-slip surface <i>Matches drawer finish 506</i></p>	300 mm unit width	182	ZIM 30 SG	2	
	400 mm unit width	282	ZIM 40 SG	2	
	450 mm unit width	332	ZIM 45 SG	2	
	500 mm unit width	382	ZIM 50 SG	3	
	600 mm unit width	482	ZIM 60 SG	3	
	800 mm unit width	682	ZIM 80 SG	4	
	900 mm unit width	782	ZIM 90 SG	4	
	1000 mm unit width	882	ZIM 100 SG	4	
	1200 mm unit width	1082	ZIM 120 SG	5	
 <p>Mat Set of 2 silver-grey for LeMans carousel shelves <i>Specify hinge.</i> <i>Matches drawer finish 506</i></p>	45 cm door width		ZIML 45 SG2	9	
	50 cm door width		ZIML 50 SG2	9	
	60 cm door width		ZIML 60 SG2	9	
 <p>Mat Set of 2 silver-grey for wooden carousel shelf with metal rail Semi-circular version <i>Matches drawer finish 506</i></p>	UE 115 KP		ZIMK 115 SG2	9	
 <p>Mat Set of 2 silver-grey for corner base unit carousel for wooden carousel shelf with metal rail <i>Matches drawer finish 506</i></p>	UE 80 KP		ZIMK 801 SG2	8	
	UE 90 KP		ZIMK 901 SG2	8	
 <p>Mat Anthracite for deep drawers and drawers 474 mm deep Grooved anti-slip surface <i>Suitable for drawers 508, 510 and 512</i></p>	300 mm unit width	182	ZIM 30 AN	2	
	400 mm unit width	282	ZIM 40 AN	2	
	450 mm unit width	332	ZIM 45 AN	2	
	500 mm unit width	382	ZIM 50 AN	3	
	600 mm unit width	482	ZIM 60 AN	3	
	800 mm unit width	682	ZIM 80 AN	4	
	900 mm unit width	782	ZIM 90 AN	4	
	1000 mm unit width	882	ZIM 100 AN	4	
	1200 mm unit width	1082	ZIM 120 AN	5	
 <p>Mat Set of 2 Anthracite for LeMans carousel shelves <i>Specify hinge.</i> <i>Suitable for drawers 508, 510 and 512</i></p>	45 cm door width		ZIML 45 AN2	9	
	50 cm door width		ZIML 50 AN2	9	
	60 cm door width		ZIML 60 AN2	9	
 <p>Mat Set of 2 Anthracite for wooden carousel shelf with metal rail Semi-circular version <i>Suitable for drawers 508, 510 and 512</i></p>	UE 115 KP		ZIMK 115 AN2	9	



Mats

				Item	universal
		width			
 <p>Mat Set of 2 Anthracite for wooden carousel shelf with metal rail <i>Suitable for drawers 508, 510 and 512</i></p>	UE 80 KP		ZIMK 801 AN2	8	
	UE 90 KP		ZIMK 901 AN2	8	
 <p>Drip tray aluminium tray, textured, 518 mm deep back and side edges raised, front edge lowered, to cover front carcass edge. if required, cut out front corner for waste bin bearing.</p>	450 mm unit width	417	EZIT 45 A	5	
	500 mm unit width	467	EZIT 50 A	5	
	600 mm unit width	567	EZIT 60 A	6	
	800 mm unit width	767	EZIT 80 A	7	
	900 mm unit width	867	EZIT 90 A	7	
	1000 mm unit width	967	EZIT 100 A	8	
	1200 mm unit width	1167	EZIT 120 A	8	
 <p>Drip tray silver grey plastic for sink units Protection against overflows and spills in the sink area. The mat is easy to remove for cleaning. 522 mm deep.</p>	450 mm unit width	417	ZIT 45 SG	4	
	500 mm unit width	467	ZIT 50 SG	4	
	600 mm unit width	567	ZIT 60 SG	5	
	800 mm unit width	767	ZIT 80 SG	6	
	900 mm unit width	867	ZIT 90 SG	6	
	1000 mm unit width	967	ZIT 100 SG	7	
	1200 mm unit width	1167	ZIT 120 SG	7	

Interior equipment

			width	Item	universal
 <p>Hanging basket silver-grey</p> <p>III. shows ZIK 30</p>	for tall unit and highboard			ZIK 30	6
	for base unit 2 each			ZIK 30 S2	10
 <p>III. shows ZIK 30 S2</p>					
 <p>Insert tray plastic white 12 mm high</p> <p><i>Can be combined with hanging basket, silver grey, item ZIK 30</i></p>	for provision units tall unit and highboard			ZIE 30	3
 <p>Hanging basket Wooden shelf with metal rail</p>				ZIK 30 P	7
	For diagonal base unit 2 each			ZIK 25 S2	10
	For diagonal tall unit			ZIK 25 T	11
	for Tandem Solo tall unit and highboard			ZIK 60	15

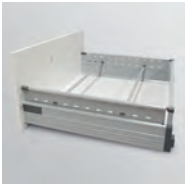
Interior equipment

		width	Item	universal
 <p>Side panels glass 2 items in set</p>	Clear glass with depth reduction 270 mm		ZIAG 27 KG	3
	Clear glass with depth reduction 400 mm		ZIAG 40 KG	3
	Clear glass with standard depth		ZIAG 50 KG	3
	Frosted glass with depth reduction 270 mm		ZIAG 27 MG	3
	Frosted glass with depth reduction 400 mm		ZIAG 40 MG	3
	Frosted glass with standard depth		ZIAG 50 MG	3
 <p>Carrier for interior drawer / interior deep drawer for screwing on the front panel 1 each <i>Cannot be used with hinged doors.</i></p>			ZIS 1	2
 <p>Side panels silver-grey for deep drawers for clipping onto the railing right and left as a set <i>For drawer version TANDEMBOX plus</i> <i>Matches drawer finish 506</i></p>			ZBA 500 SG	2
 <p>Crossbar silver-grey for deep drawers for clipping in between ZBA 500 SG side panels per item <i>side panels ZBA500SG.</i></p>	for 600 mm unit width for 900 mm unit width		ZBZ 60 SG ZBZ 90 SG	2 2
 <p>Towel rail aluminium silver coloured anodised 450 mm deep, from 150 mm unit width on runners to be fitted onto top shelf or carcass side</p>	2-arm	92	ZI 2	5
 <p>Towel rail same as above, but from 300 mm unit width <i>150 mm carcass width: fitting not possible!</i></p>	3-arm	147	ZI 3	6



Interior equipment

	width	Item	universal
 <p>Bottle basket white with handle, for 6 bottles 281 mm high, 310 mm deep for deep drawers and larder units</p>	195	Zl 61 W	7

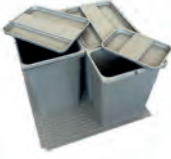

Waste bins, Waste separation systems

	width	Item	universal
 <p>Waste bin Grey plastic container with fitted plastic bin, Capacity 13 litres in sink base unit from 400 mm wide Minimum built-in height 400 mm <i>Installation dimensions (H x D): 470 x 285 mm</i></p>	340	ZAT 40	9
 <p>Waste bin with 2 plastic containers Total volume 19 litres 1 container 14 litres 1 container, 5 litres, removable <i>Minimum installation height 470 mm</i> <i>Installation dimensions (H x D): 410 x 210 mm</i></p>	NEW 410	ZAT 45 19G	20
 <p>Waste separation system with 2 plastic containers capacity 15 litres each to be fitted into sink base unit from 300 mm wide <i>Minimum installation height 455 mm</i> <i>Depth: 505 mm</i> <i>Can be fitted in corner base unit.</i> <i>Not suitable for fitting in deep drawers.</i> <i>When fitting in sink base units, observe basin height including outlet fitting.</i></p>	262	ZA 30	20
 <p>Waste separation system with 2 plastic containers Capacity each 10 litres to be fitted into sink base unit from 300 mm wide <i>Minimum installation height 470 mm</i> <i>Depth: 330 mm</i> <i>Can be fitted in corner base unit.</i> <i>Not suitable for fitting in deep drawers.</i> <i>When fitting in sink base units, observe basin height including outlet fitting.</i></p>	262	ZA 30 33	40
 <p>Waste separation system 1 container, capacity 18 litres 2 containers, capacity 8.5 litres each 1 container lid for 8.5 litre container in sink base unit from 400 mm wide 336 mm high, 475 mm deep container on full extension runners <i>Can be fitted in corner base unit.</i> <i>Not suitable for fitting in deep drawers.</i></p>	346	ZA 401	26
 <p>Waste separation system 2 containers, capacity 15 litres each to be fitted into sink base unit from 500 mm wide container on full extension runners mounting to the cabinet base <i>345 mm high, 325 mm deep</i> <i>Can be fitted in corner base unit.</i> <i>Not suitable for fitting in deep drawers.</i></p>	455	ZA502S	32

Waste separation systems, Accessories for sinks

		width	Item	universal
 <p>Waste recycling system 2 containers 17 litres each, each with lid 1 container 8 litres with lid 1 base panel</p> <p>Container height: 310 mm</p> <p>Installation in pull out units 60 cm wide Can only be installed in deep drawer heights from 357 mm.</p> <p>Do not include for pull-outs in range C.</p> 	60 cm deep drawer width <small>NEW</small>	560	ZAA 60 31 N	22
 <p>Space-saving waste and trap assembly suitable for all sinks waste pipe Ø 50 mm with connection to dishwasher</p> <p>Required if waste bin is built in. white</p>			ZSZ 1 G	5
 <p>„Water“ installation set consisting of: 1 ball siphon 1 1/2" x 40 mm 1 space-saving connector 1 HT elbow DN40/87 1 HT pipe 40 x 250 mm 1 sink unit reinforcement 1 hose clip 16 - 25 mm, W4 1 HT adapter 40/50 DN 1 flexible connection hose, 3/8" cover ring x 10 mm 1 sealing tape for 5-metre worktop</p> <p>Available within Germany.</p>			MZ SET W	17
 <p>„Water and Electricity“ installation set 1 ball siphon 1 1/2" x 40 mm 1 space-saving connector 1 HT elbow DN40/87 1 HT pipe 40 x 250 mm 1 HT adapter 40/50 DN 1 sink unit reinforcement 1 cooker power supply cable 5 x 2.5 mm² 1 flexible connection hose, 3/8" cover ring x 10 mm 1 hose clip 16 - 25 mm, W4 1 3-way worktop plug socket, 1.5 m connection lead 1 sealing tape for 5-metre worktop</p> <p>Available within Germany.</p>			MZ SET WS	20
 <p>Drip tray aluminium tray, textured, 518 mm deep back and side edges raised, front edge lowered, to cover front carcass edge. if required, cut out front corner for waste bin bearing.</p>	450 mm unit width 500 mm unit width 600 mm unit width 800 mm unit width 900 mm unit width 1000 mm unit width 1200 mm unit width	417 467 567 767 867 967 1167	EZIT 45 A EZIT 50 A EZIT 60 A EZIT 80 A EZIT 90 A EZIT 100 A EZIT 120 A	5 5 6 7 7 8 8

Other accessories

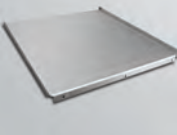
		width		Item	universal
 <p>Add-on towel rail aluminium Surface brushed stainless steel effect Overhang at front: 37 mm</p> <p>Adjust to the front thickness with the enclosed felt strip</p> <p><i>Cannot be used with fitted strip handle.</i></p>	300 mm	300	ZH 320 E	8	
	500 mm	500	ZH 520 E	13	
 <p>Add-on towel rail black Surface brushed stainless steel effect Overhang at front: 37 mm</p> <p>Adjust to the front thickness with the enclosed felt strip</p> <p><i>Cannot be used with fitted strip handle.</i></p>	300 mm	300	ZH 320 S	8	
	500 mm	500	ZH 520 S	13	
 <p>Heat-protection shelf For base units with drawers on top and hob above. For unit depth 560 mm. Used as contact protection and heat insulation.</p> <p><i>A distance of approx. 20 mm to the bottom edge of the worktop results. During planning and installation, it is essential to observe the safety distances of the electrical appliance manufacturer!</i></p>	300 mm unit width	267	ZV 30	8	
	400 mm unit width	367	ZV 40	8	
	450 mm unit width	417	ZV 45	9	
	500 mm unit width	467	ZV 50	9	
	600 mm unit width	567	ZV 60	10	
	800 mm unit width	767	ZV 80	11	
	900 mm unit width	867	ZV 90	11	
	1000 mm unit width	967	ZV 100	12	
	1200 mm unit width	1167	ZV 120	13	
	<p>Heat-protection shelf Installed directly above a dishwasher or refrigerator with overlying hob. An induction hob is also possible. For unit depth 560 mm. Used as contact protection and heat insulation.</p> <p><i>A distance of approx. 35 mm to the bottom edge of the worktop results. During planning and installation, it is essential to observe the safety distances of the electrical appliance manufacturer!</i></p>	600 mm unit width	600	ZV 601	13

3. Wall units / dresser units

Legend of symbols used

Summary of the most commonly planned wall units

Wall/top-mounted units 291/363/435 mm

Wall units 579 mm, height 01

Wall units 723 mm, height 02

Wall units 867 mm, height 03

Wall units for appliances

Chimney hoods and back panels

Dresser units

Filler panels

Legend of symbols used



Width reduction

For surcharges and information see register 9 Design elements, special topics, sub-register Surcharges/miscellaneous

Units shortened to the next smallest unit width available.
Example: unit width 600 mm = shortened to 501 mm

Reduction only available for reducible ranges with edging finish.
Possible ranges:
IP 1200, IP 2200, IP 3150, IP 4050

Width reduction of D-handles and knobs is possible.

Handle designs depending on length (bar handles, grip ledges) are not possible where width is shortened.



Depth reduction

For surcharges and information see register 9 Design elements, special topics, sub-register Surcharges/miscellaneous



Width and depth reduction

Combination of both variants

For surcharges and information see register 9 Design elements, special topics, sub-register Surcharges/miscellaneous



Interior finish

Unit interior in carcass finish
Not available in visible side colours.



Display wall unit

with handle drilling at the top

Information on customised products



Please note the possible customisations for cabinets.

The following individualisations are possible:

- Width reduction
- Depth reduction
- Carcase with increased side depth



You will find further information on this under register 9 Design elements, special topics, sub-register Surcharges/miscellaneous.

Equipment versions

 	<p>Clip hinge, standard version Version 414 in combination with a high-quality flap stay</p>
 	<p>Cushioning for hinged doors Top Motion (surcharge) Version 418 Integrated door cushioning CLIP top BLUMOTION by Blum in combination with a high-quality flap stay</p>
 	<p>Cushioning for hinged doors Top Motion (surcharge) Version 428 Integrated door cushioning CLIP top BLUMOTION by Blum in combination with AVENTOS HKS flap stay by Blum</p>
	<p>Flap holder, standard version Version 414</p>
	<p>Flap holder, standard version (surcharge) Version 418 in combination with CLIP top BLUMOTION cushioning for hinged doors by Blum</p>
	<p>AVENTOS HKS flap stay by Blum (surcharge) Version 428 in combination with CLIP top BLUMOTION cushioning for hinged doors by Blum</p>

LED lighting options for wall units

Order electronic LED transformers, start sets and connection accessories separately.

		width	Item	universal		
<p>Planning advice</p> <p>Choosing the surcharge for the lighting option on the wall unit means the bottom shelf and/or the top shelf will have the required cut-out. The up/down lighting is fitted at the works, LED linear and LED built-in lights are added to the accessories box and have to be fitted on-site. This makes the order process easier as there is no need to order the lights in addition to the cut-out.</p> <p>The shelf features are chosen in the order header: 963 = features of bottom shelf 964 = features of top shelf</p> <p>Please observe the following planning information: - Available for cabinet widths 300 - 1000 mm - Width and depth reductions are not possible - 60 cm and 65 cm corner wall units, diagonal wall units, shelf units in variable dimensions, end shelf units are not possible</p> <p>Order electronic LED transformers, start sets and connection accessories separately.</p>						
	<p>Grip ledge with up/down LED lighting</p> <p>Version 200, surcharge per unit</p> <p>Surcharge includes:</p> <p>Grip ledge with up/down LED lighting in bottom shelf of carcass instead of handle profile without lighting</p> <p>Light colour temperature:</p> <p>with control unit: 2700 - 6500 K, without control unit: 2700 K including 1.8 metre extension cable as an accessory with mini-plug</p> <p>Light source energy efficiency class</p> <p>Top: F</p> <p>Bottom: G</p> <p><i>Only possible for wall units with integrated handle profile on carcass base panel (article types CH...).</i></p> <p><i>Do not include light pelmets in plans.</i></p>	<p>5.8 W, 490 lm</p> <p>8.2 W, 673 lm</p> <p>9.3 W, 764 lm</p> <p>10.5 W, 856 lm</p> <p>12.8 W, 1039 lm</p> <p>17.5 W, 1405 lm</p> <p>19.8 W, 1588 lm</p> <p>22.1 W, 1771 lm</p>	<p>300</p> <p>400</p> <p>450</p> <p>500</p> <p>600</p> <p>800</p> <p>900</p> <p>1000</p>	MP963	23	
		<p>LED built-in spotlight</p> <p>Extra charge per cabinet</p> <p>Version 221 = stainless steel effect</p> <p>Surcharge includes:</p> <p>cut-out in bottom shelf of cupboard</p> <p>LED built-in spotlight, ZLI 58 ...</p> <p>Each light: 4.0 W, 250 lm</p> <p>Light colour temperature: 3000 K</p> <p>with connecting cable, 2 metres, including mini-plug</p> <p>Light source energy efficiency class: F</p>	<p>1 light</p> <p>for units to 600 mm wide</p>		MP963	8
		<p>LED built-in spotlight with colour control</p> <p>Extra charge per cabinet</p> <p>Version 220 = stainless steel effect</p> <p>Version 222 = black</p> <p>Surcharge includes:</p> <p>cut-out in bottom shelf of cupboard</p> <p>with connecting cable, 2 metres, including mini-plug</p> <p>Energy efficiency of light source: refer to individual item</p> <p>Version 220 = stainless steel effect: LED built-in spotlight, ZLI 58 ECC Each light: 3.0 W, 160 lm Light colour temperature: with control unit: 3000 - 6000 K without control unit: 3000 K</p> <p>Version 222 = black: LED built-in spotlight: ZLI 58 SCC Each light: 4.0 W, 250 lm Light colour temperature: with control unit: 2700 - 6500 K without control unit: 2700 K</p>	<p>Version 220 = stainless steel effect</p> <p>1 light</p> <p>for units to 600 mm wide</p>		MP963	11
			<p>Version 220 = stainless steel effect</p> <p>2 lights</p> <p>for units from 800 mm wide</p>	MP963	15	
		<p>Version 220 = stainless steel effect: LED built-in spotlight, ZLI 58 ECC Each light: 3.0 W, 160 lm Light colour temperature: with control unit: 3000 - 6000 K without control unit: 3000 K</p> <p>Version 222 = black: LED built-in spotlight: ZLI 58 SCC Each light: 4.0 W, 250 lm Light colour temperature: with control unit: 2700 - 6500 K without control unit: 2700 K</p>	<p>Version 220 = stainless steel effect</p> <p>2 lights</p> <p>for units from 800 mm wide</p>		MP963	21
			<p>Version 222 = black</p> <p>1 light</p> <p>for units to 600 mm wide</p>	MP963	11	
		<p>Version 222 = black: LED built-in spotlight: ZLI 58 SCC Each light: 4.0 W, 250 lm Light colour temperature: with control unit: 2700 - 6500 K without control unit: 2700 K</p>	<p>Version 222 = black</p> <p>2 lights</p> <p>for units from 800 mm wide</p>		MP963	21



LED lighting options for wall units

Order electronic LED transformers, start sets and connection accessories separately.

		width	Item	universal
	Cutout without light 58 mm in diameter Extra charge per cabinet Version 229 Surcharge includes: cut-out in bottom shelf of cupboard 1 cut-out for units up to 600 mm width 2 cut-outs for units from 800 mm width	<small>NEW</small>	MP963	7
	Cutout without light 68 mm in diameter Extra charge per cabinet Version 449 Surcharge includes: cut-out in bottom shelf of cupboard 1 cut-out for units up to 600 mm width 2 cut-outs for units from 800 mm width	<small>NEW</small>	MP963	7
 LED built-in light, straight aluminium profile Extra charge per cabinet Version 210 = stainless steel effect Surcharge includes: cut-out in bottom shelf of cupboard LED built-in light ZLIL...ECC Light colour temperature: with control unit: 2700 - 6500 K, without control unit: 2700 K with connecting cable, 2 metres, including mini-plug Light source energy efficiency class: G	3 W, 288 lm	300	MP963	18
	4.2 W, 396 lm	400		
	4.8 W, 450 lm	450		
	5.4 W, 504 lm	500		
	6.6 W, 612 lm	600		
	9 W, 828 lm	800		
	10.2 W, 936 lm	900		
	11.4 W, 1044 lm	1000		

LED lighting options for wall units

Order electronic LED transformers, start sets and connection accessories separately.

		width	Item	universal	
 <p>LED built-in spotlight Extra charge per cabinet Version 221 = stainless steel effect Surcharge includes: Cut-out in top shelf of cupboard LED built-in spotlight, ZLI 58 ... Each light: 4.0 W, 250 lm Light colour temperature: 3000 K with connecting cable, 2 metres, including mini-plug Light source energy efficiency class: F</p>	1 light for units to 600 mm wide		MP964	8	
	2 lights for units from 800 mm wide		MP964	15	
	LED built-in spotlight with colour control Extra charge per cabinet Version 220 = stainless steel effect Version 222 = black Surcharge includes: Cut-out in top shelf of cupboard with connecting cable, 2 metres, including mini-plug Energy efficiency of light source: refer to individual item	Version 220 = stainless steel effect 1 light for units to 600 mm wide		MP964	11
	Version 220 = stainless steel effect: LED built-in spotlight, ZLI 58 ECC Each light: 3.0 W, 160 lm Light colour temperature: with control unit: 3000 - 6000 K without control unit: 3000 K	Version 220 = stainless steel effect 2 lights for units from 800 mm wide		MP964	21
	Version 222 = black: LED built-in spotlight: ZLI 58 SCC Each light: 4.0 W, 250 lm Light colour temperature: with control unit: 2700 - 6500 K without control unit: 2700 K	Version 222 = black 1 light for units to 600 mm wide		MP964	11
	Version 222 = black 2 lights for units from 800 mm wide		MP964	21	
	Cutout without light 58 mm in diameter Extra charge per cabinet Version 229 Surcharge includes: Cut-out in top shelf of cupboard 1 cut-out for units up to 600 mm width 2 cut-outs for units from 800 mm width	<small>NEW</small>	MP964	7	
	Cutout without light 68 mm in diameter Extra charge per cabinet Version 449 Surcharge includes: Cut-out in top shelf of cupboard 1 cut-out for units up to 600 mm width 2 cut-outs for units from 800 mm width	<small>NEW</small>	MP964	7	
 <p>LED built-in light, straight aluminium profile Extra charge per cabinet Version 210 = stainless steel effect Surcharge includes: Cut-out in top shelf of cupboard LED built-in light ZLIL...ECC Light colour temperature: with control unit: 2700 - 6500 K, without control unit: 2700 K with connecting cable, 2 metres, including mini-plug Light source energy efficiency class: G</p>	3 W, 288 lm	300	MP964	18	
	4.2 W, 396 lm	400			
	4.8 W, 450 lm	450			
	5.4 W, 504 lm	500			
	6.6 W, 612 lm	600			
	9 W, 828 lm	800			
	10.2 W, 936 lm	900			
	11.4 W, 1044 lm	1000			

Notes

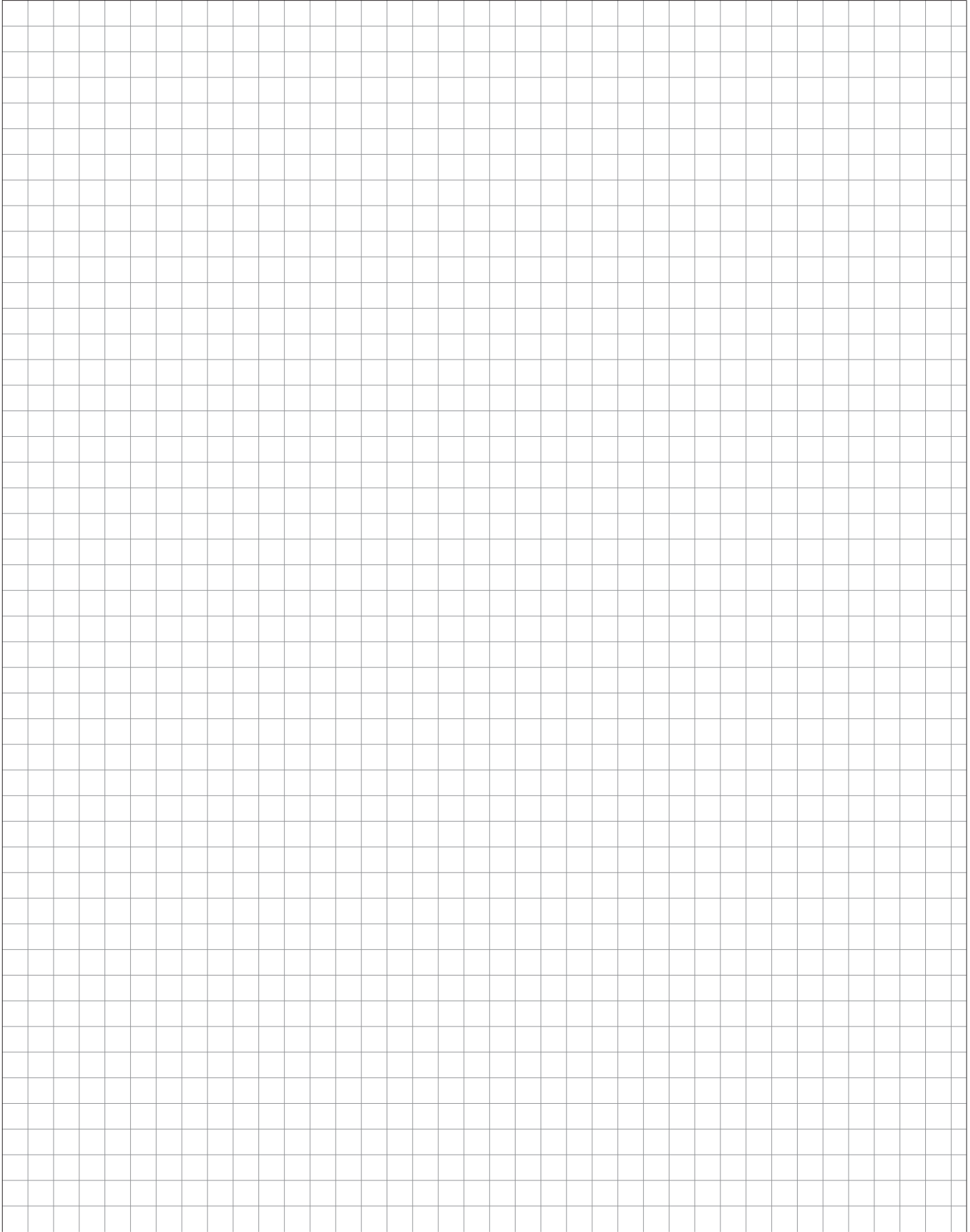

Summary of the most commonly planned wall units

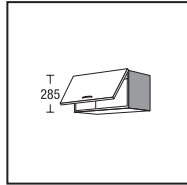

HK3029
HK4029
HK4529
HK5029
HK6029
HK8029
HK9029
HK10029

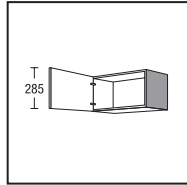

H4029
H4529
H5029
H6029

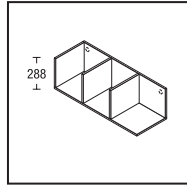

HR90292

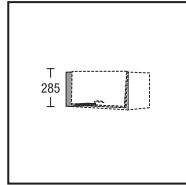

HPF1029
HPF2029

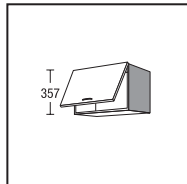

HK5036
HK6036
HK8036
HK9036
HK10036

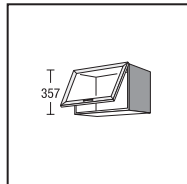

HKG5036
HKG6036
HKG8036
HKG9036
HKG10036

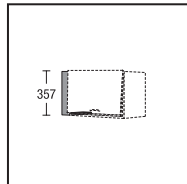

HPF1036
HPF2036

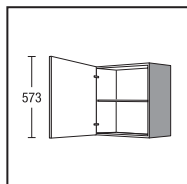

H3001
H4001
H4501
H5001
H6001

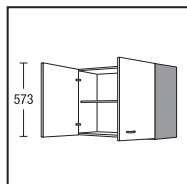

H8001
H9001
H10001

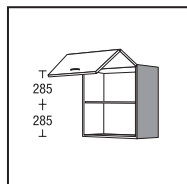

HFK4501
HFK5001
HFK6001
HFK8001
HFK9001
HFK10001

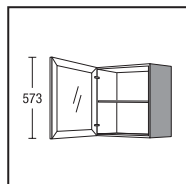

HG4501
HG5001
HG6001
HG4501D
HG5001D
HG6001D

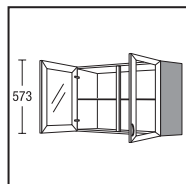

HG9001
HG10001

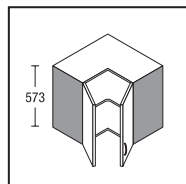

HE6001
HE6501

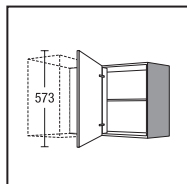

HE8001
HE9001

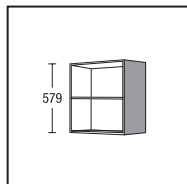

HR3001
HR4501
HR5001
HR6001

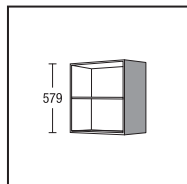

HRV01

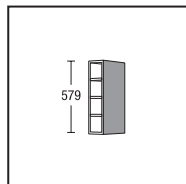

HR1501F

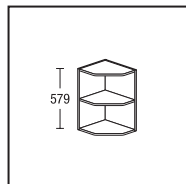

HRA2501S

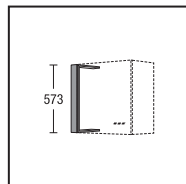

HPF1001
HPF2001

Summary of the most commonly planned wall units

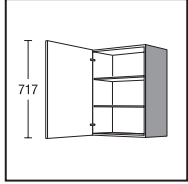

H3002
H4002
H4502
H5002
H6002

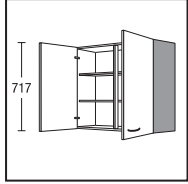

H8002
H9002
H10002

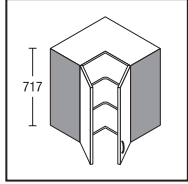

HE6002
HE6502

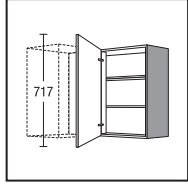

HE8002
HE9002

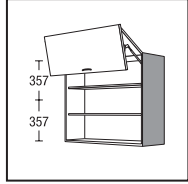

HFK5002
HFK6002
HFK8002
HFK9002
HFK10002

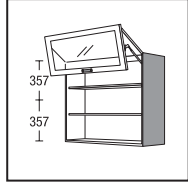

HFKGU5002
HFKGU6002
HFKGU8002
HFKGU9002
HFKGU10002

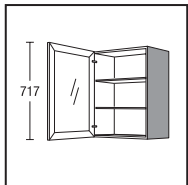

HG4502
HG5002
HG6002
HG4502D
HG5002D
HG6002D

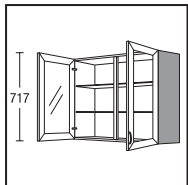

HG9002
HG10002

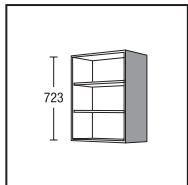

HR3002
HR4502
HR5002
HR6002

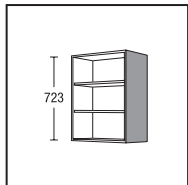

HRV02

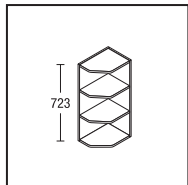

HRA2502S

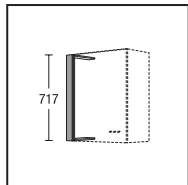

HPF1002
HPF2002

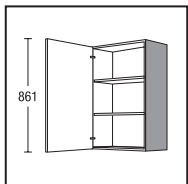

H3003
H4003
H4503
H5003
H6003

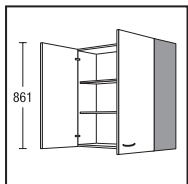

H8003
H9003
H10003

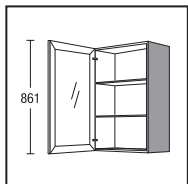

HG4503
HG5003
HG6003
HG4503D
HG5003D
HG6003D

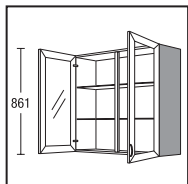

HG9003
HG10003

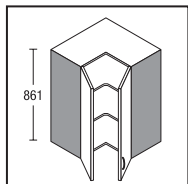

HE6003
HE6503

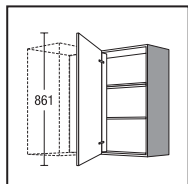

HE8003
HE9003

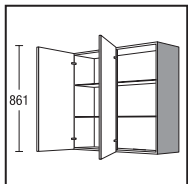

H8003TP
H9003TP
H10003TP

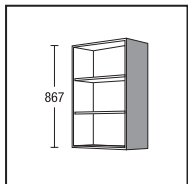

HRV03

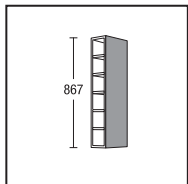

HRA2503S

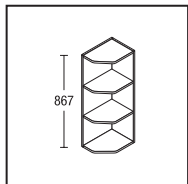

HM6003

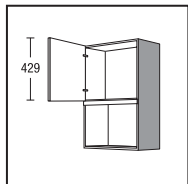

HPF1003
HPF2003

Wall/top-mounted units 291/363/435 mm

Wall/top-mounted units
291/363/435 mm

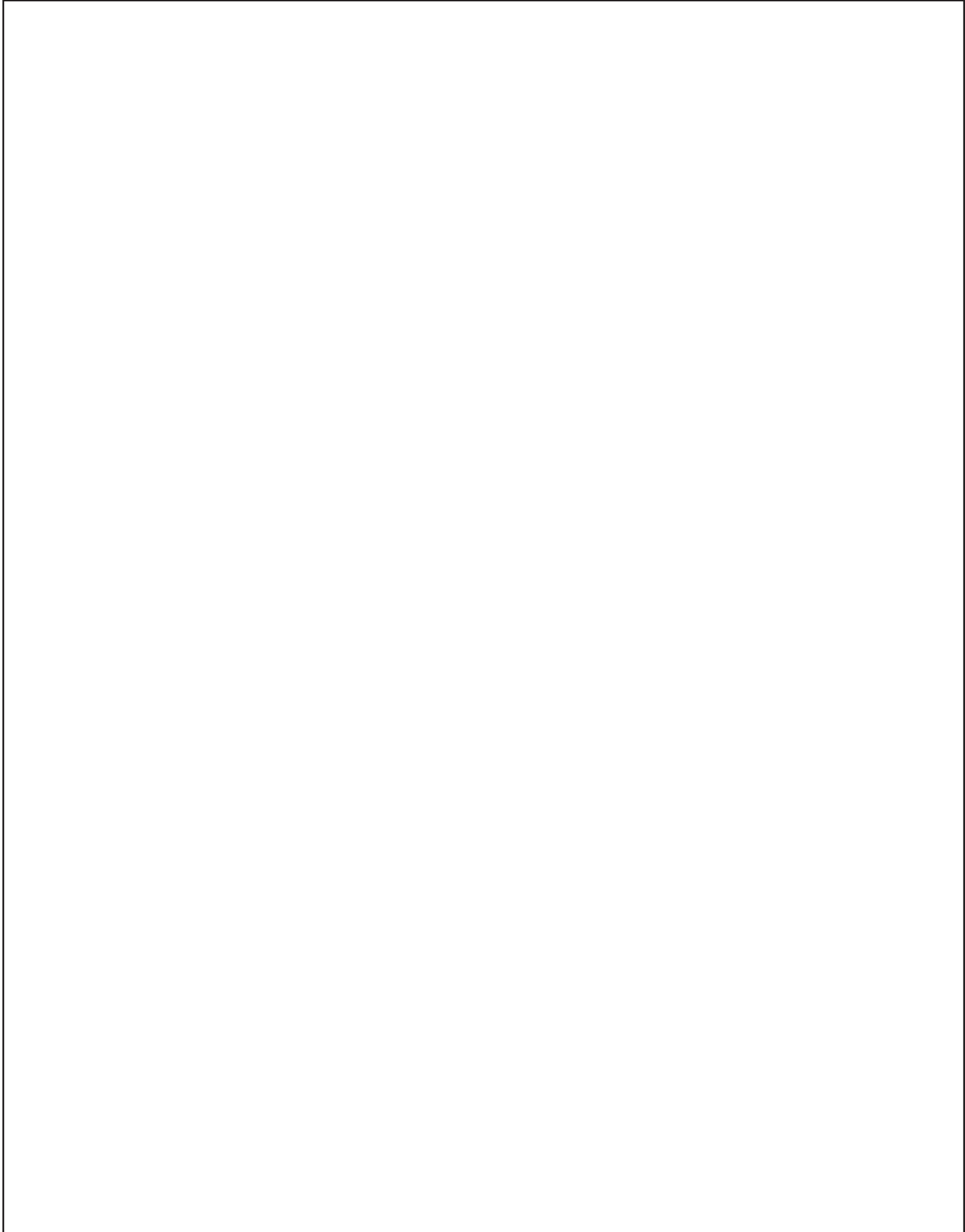





Wall units

291 mm

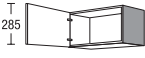
Carcase depth 326 mm

				Price group												
				width	1	2	3	4	5	6	7	Servosoft	Pro Servosoft	ProServoglass	Soft closing Top Motion	Soft closing Top Motion Plus
 <p>Wall unit 1 hinged door</p> <p>Cannot be combined with handles No. 760 and No. 800.</p> <p>Not available for the following ranges: IP 4820, IP 7500</p>	H	40	29		30	32	33	35	44	48	54	-	-	-	4	4
	H	45	29	32	34	35	37	46	50	56	-	-	-	4	4	
	H	50	29	34	36	38	41	48	52	58	-	-	-	4	4	
	H	60	29	36	39	41	44	51	55	61	-	-	-	4	4	
 <p>Wall unit above cooker hoods 1 flap door</p> <p>Handle only fitted horizontally</p> <p>in combination with wall unit height 01 and as a top unit on HD 60 46 and TD 6046 with extractor with height 03.</p>	HK	30	29	34	36	37	39	48	52	58	-	-	-	4	14	
	HK	40	29	36	38	39	41	50	54	60	-	-	-	4	14	
	HK	45	29	38	40	41	43	52	56	62	-	-	-	4	14	
	HK	50	29	40	42	44	47	54	58	64	-	-	-	4	14	
	HK	60	29	41	44	46	49	56	60	66	-	-	-	4	14	
	HK	80	29	56	60	63	67	76	82	90	-	-	-	4	14	
	HK	90	29	60	64	67	71	81	85	93	-	-	-	4	14	
	HK	100	29	64	68	71	75	85	89	97	-	-	-	4	14	
 <p>Wall open shelf unit</p> <p>Shelf depth defined by kitchen range. Specify kitchen range!</p> <p>Finish in carcass material</p> <p>Not available in visible side colours.</p>	NEW	HR	30	29	76	76	76	76	76	76	-	-	-	-	-	
	NEW	HR	40	29	78	78	78	78	78	78	-	-	-	-	-	
	NEW	HR	45	29	79	79	79	79	79	79	-	-	-	-	-	
	NEW	HR	50	29	80	80	80	80	80	80	-	-	-	-	-	
	NEW	HR	60	29	82	82	82	82	82	82	-	-	-	-	-	
	NEW	HR	80	29	89	89	89	89	89	89	-	-	-	-	-	
	NEW	HR	90	29	92	92	92	92	92	92	-	-	-	-	-	
	NEW	HR	100	29	95	95	95	95	95	95	-	-	-	-	-	



Illustrations do not correspond to the door finishes.

3.09

Wall units

291 mm

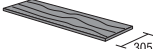
Carcase depth 326 mm

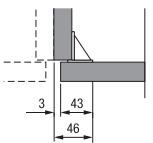
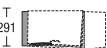
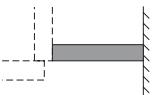

		width	Price group							Servosoft	Pro Servosoft	ProServoGlass	Soft closing Top Motion	Soft closing Top Motion Plus		
			1	2	3	4	5	6	7							
 <p>System shelf unit Set consisting of: 2 metal frames, black 1 shelf in carcass material, 305 mm deep</p> <p><i>High-gloss finish not available.</i></p> <p><i>Installation recommendation - projecting shelves:</i> 50 mm projection up to 450 mm shelf width 75 mm projection from 500 mm shelf width</p>	HR	30	29	TR	46	46	46	46	46	46	46	-	-	-	-	
	HR	40	29	TR	47	47	47	47	47	47	47	-	-	-	-	
	HR	45	29	TR	48	48	48	48	48	48	48	-	-	-	-	
	HR	50	29	TR	49	49	49	49	49	49	49	-	-	-	-	
	HR	60	29	TR	50	50	50	50	50	50	50	-	-	-	-	
	HR	80	29	TR	52	52	52	52	52	52	52	-	-	-	-	
	HR	90	29	TR	53	53	53	53	53	53	53	-	-	-	-	
	Individual frames for system shelf unit 1 metal frame, black <i>For individual design.</i> <i>We recommend the use of 3 frames for shelf widths above 900 mm.</i> <i>Installation recommendation - projecting shelves:</i> 50 mm projection up to 450 mm shelf width 75 mm projection from 500 mm shelf width <i>Order shelf RBxx (305 mm deep) separately!</i>	TRH	29		21	21	21	21	21	21	21	21	-	-	-	-
	 <p>Individual shelves for system shelf unit 1 shelf in carcass material, 305 mm deep <i>For individual design.</i> <i>Installation recommendation - projecting shelves:</i> 50 mm projection up to 450 mm shelf width 75 mm projection from 500 mm shelf width <i>Order frame TRHxx separately!</i></p>	RB	30		12	12	12	12	12	12	12	12	-	-	-	-
		RB	40		12	12	12	12	12	12	12	12	-	-	-	-
RB		45		12	12	12	12	12	12	12	12	-	-	-	-	
RB		50		12	12	12	12	12	12	12	12	-	-	-	-	
RB		60		13	13	13	13	13	13	13	13	-	-	-	-	
RB		80		15	15	15	15	15	15	15	15	-	-	-	-	
RB		90		16	16	16	16	16	16	16	16	-	-	-	-	
 <p>Infill panel for wall units Fitted between wall and carcass side <i>Finish in door material without edging on the wall side</i> <i>Not available in visible side colours.</i></p> 	HPF	10	29		14	17	18	19	20	22	26	-	-	-	-	
	HPF	20	29		23	26	28	30	32	35	39	-	-	-	-	
 <p>Infill panel for wall units <i>Finish in carcass material</i> <i>Not available in visible side colours.</i></p> 	HPK	10	29		11	11	11	11	11	11	11	-	-	-	-	
	HPK	20	29		15	15	15	15	15	15	15	-	-	-	-	
	HPK	30	29		19	19	19	19	19	19	19	-	-	-	-	

3.10 Illustrations do not correspond to the door finishes.

Wall units

363 mm high

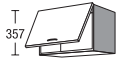
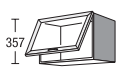
Carcase depth 326 mm

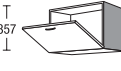
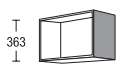
		width		Price group							Servosoft	Pro Servosoft	ProServoglass	Soft closing Top Motion	Soft closing Top Motion Plus	
				1	2	3	4	5	6	7						
 <p>Wall unit 1 flap door <i>Handle only fitted horizontally</i></p>	HK	50	36	47	51	53	56	65	69	76	-	-	-	4	14	
	HK	60	36	48	52	54	57	66	71	78	-	-	-	4	14	
	HK	80	36	61	65	69	73	83	89	98	-	-	-	7	31	
	HK	90	36	65	69	73	77	88	92	101	-	-	-	7	31	
	HK	100	36	69	73	77	81	92	96	105	-	-	-	7	31	
 <p>Wall unit with glass flap door 1 glass flap door <i>Handle only fitted horizontally</i> <i>For glass and frame finishes please refer to programme summary</i></p> <p>Framed glass door No. 701 <i>Available for the following ranges: IP 1200, IP 2200, IP 3150, IP 4050</i></p>	HKG	50	36	96	104	109	115	134	143	157	-	-	-	4	14	
	HKG	60	36	99	108	112	118	137	148	163	-	-	-	4	14	
	HKG	80	36	112	120	127	135	153	165	182	-	-	-	7	31	
	HKG	90	36	116	123	131	138	158	165	182	-	-	-	7	31	
	HKG	100	36	122	129	136	144	163	171	187	-	-	-	7	31	
 <p>Wall unit with glass flap door 1 glass flap door <i>For glass and frame finishes please refer to programme summary</i></p>	CHKG	50	36	N1	128	134	137	144	155	161	176	-	-	-	4	14
	CHKG	60	36	N1	136	142	145	152	164	171	185	-	-	-	4	14
	CHKG	80	36	N1	150	157	164	170	187	197	212	-	-	-	7	31
	CHKG	90	36	N1	158	165	171	177	195	202	215	-	-	-	7	31
	CHKG	100	36	N1	168	175	181	187	205	213	227	-	-	-	7	31
 <p>Wall unit with bar flap door 1 flap door with high-quality flap stay 1 magnet <i>Handle only fitted horizontally</i> <i>Cannot be combined with handle no. 783.</i></p>	HKU	50	36	59	64	67	70	82	87	96	-	-	-	4	14	
	HKU	60	36	61	66	69	73	84	91	100	-	-	-	4	14	
	HKU	80	36	73	78	83	87	100	107	118	-	-	-	4	14	
	HKU	90	36	77	82	87	91	104	109	120	-	-	-	4	14	
	HKU	100	36	81	86	90	95	108	113	124	-	-	-	4	14	
 <p>Wall open shelf unit <i>Shelf depth defined by kitchen range. Specify kitchen range!</i> <i>Finish in carcass material</i> <i>Not available in visible side colours.</i></p>	NEW HR	30	36	78	78	78	78	78	78	78	-	-	-	-	-	
	NEW HR	40	36	80	80	80	80	80	80	80	-	-	-	-	-	
	NEW HR	45	36	81	81	81	81	81	81	81	-	-	-	-	-	
	NEW HR	50	36	82	82	82	82	82	82	82	-	-	-	-	-	
	NEW HR	60	36	84	84	84	84	84	84	84	-	-	-	-	-	
	NEW HR	80	36	91	91	91	91	91	91	91	-	-	-	-	-	
	NEW HR	90	36	94	94	94	94	94	94	94	-	-	-	-	-	
NEW HR	100	36	97	97	97	97	97	97	97	-	-	-	-	-		





Illustrations do not correspond to the door finishes.

3.11

Wall units

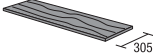
363 mm high

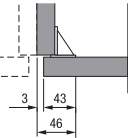

Carcase depth 326 mm

		width	Price group							Servosoft	Pro Servosoft	ProServoGlass	Soft closing Top Motion	Soft closing Top Motion Plus		
			1	2	3	4	5	6	7							
 <p>System shelf unit Set consisting of: 2 metal frames, black 1 shelf in carcase material, 305 mm deep</p> <p><i>High-gloss finish not available.</i></p> <p><i>Installation recommendation - projecting shelves:</i> 50 mm projection up to 450 mm shelf width 75 mm projection from 500 mm shelf width</p>	HR	30	36	TR	49	49	49	49	49	49	49	-	-	-	-	
	HR	40	36	TR	50	50	50	50	50	50	50	-	-	-	-	
	HR	45	36	TR	51	51	51	51	51	51	51	-	-	-	-	
	HR	50	36	TR	52	52	52	52	52	52	52	-	-	-	-	
	HR	60	36	TR	53	53	53	53	53	53	53	-	-	-	-	
	HR	80	36	TR	55	55	55	55	55	55	55	-	-	-	-	
	HR	90	36	TR	56	56	56	56	56	56	56	-	-	-	-	
	Individual frames for system shelf unit 1 metal frame, black <i>For individual design.</i> <i>We recommend the use of 3 frames for shelf widths above 900 mm.</i> <i>Installation recommendation - projecting shelves:</i> 50 mm projection up to 450 mm shelf width 75 mm projection from 500 mm shelf width <i>Order shelf RBxx (305 mm deep) separately!</i>	TRH	36		23	23	23	23	23	23	23	23	-	-	-	-
	 <p>Individual shelves for system shelf unit 1 shelf in carcase material, 305 mm deep <i>For individual design.</i> <i>Installation recommendation - projecting shelves:</i> 50 mm projection up to 450 mm shelf width 75 mm projection from 500 mm shelf width <i>Order frame TRHxx separately!</i></p>	RB	30		12	12	12	12	12	12	12	12	-	-	-	-
		RB	40		12	12	12	12	12	12	12	12	-	-	-	-
RB		45		12	12	12	12	12	12	12	12	-	-	-	-	
RB		50		12	12	12	12	12	12	12	12	-	-	-	-	
RB		60		13	13	13	13	13	13	13	13	-	-	-	-	
RB		80		15	15	15	15	15	15	15	15	-	-	-	-	
RB		90		16	16	16	16	16	16	16	16	-	-	-	-	
 <p>Infill panel for wall units Fitted between wall and carcase side <i>Finish in door material without edging on the wall side</i> <i>Not available in visible side colours.</i> <i>Due to the installation angle, the maximum possible on-site width reduction is 46 mm.</i></p> 	HPF	10	36		15	18	19	20	21	23	27	-	-	-	-	
	HPF	20	36		24	27	29	31	33	36	40	-	-	-	-	
 <p>Infill panel for wall units <i>Finish in carcase material</i> <i>Not available in visible side colours.</i></p>	HPK	10	36		12	12	12	12	12	12	12	-	-	-	-	
	HPK	20	36		16	16	16	16	16	16	16	-	-	-	-	
	HPK	30	36		20	20	20	20	20	20	20	-	-	-	-	

Wall units

435 mm high

Carcase depth 326 mm

		width		Price group							Servosoft	Pro Servosoft	ProServodglass	Soft closing Top Motion	Soft closing Top Motion Plus
		60	43	1	2	3	4	5	6	7					
 <p>Wall unit 435 mm high above cooker hoods in combination with height 02 1 flap door 1 adjustable shelf <i>Not available in visible side colours.</i></p>	HK	60	43	56	59	62	65	75	80	88	-	-	-	4	14
 <p>Wall open shelf unit <i>Shelf depth defined by kitchen range. Specify kitchen range!</i> <i>Finish in carcass material</i> <i>Not available in visible side colours.</i></p>	NEW HR	30	43	80	80	80	80	80	80	80	-	-	-	-	-
	NEW HR	40	43	82	82	82	82	82	82	82	-	-	-	-	-
	NEW HR	45	43	83	83	83	83	83	83	83	-	-	-	-	-
	NEW HR	50	43	84	84	84	84	84	84	84	-	-	-	-	-
	NEW HR	60	43	86	86	86	86	86	86	86	-	-	-	-	-
	NEW HR	80	43	93	93	93	93	93	93	93	-	-	-	-	-
	NEW HR	90	43	96	96	96	96	96	96	96	-	-	-	-	-
	NEW HR	100	43	99	99	99	99	99	99	99	-	-	-	-	-

Illustrations do not correspond to the door finishes.

Notes

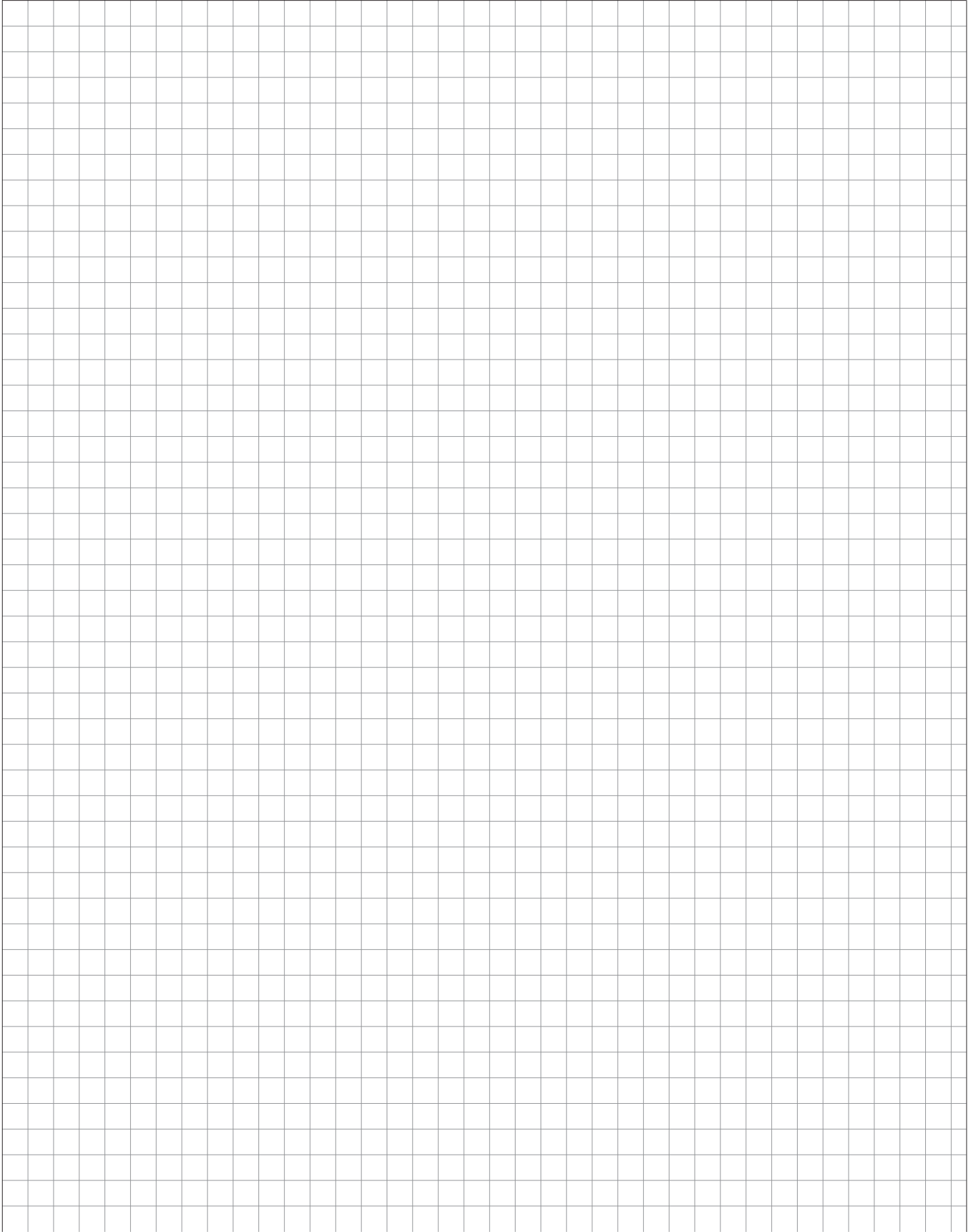

Wall units 579 mm, height 01

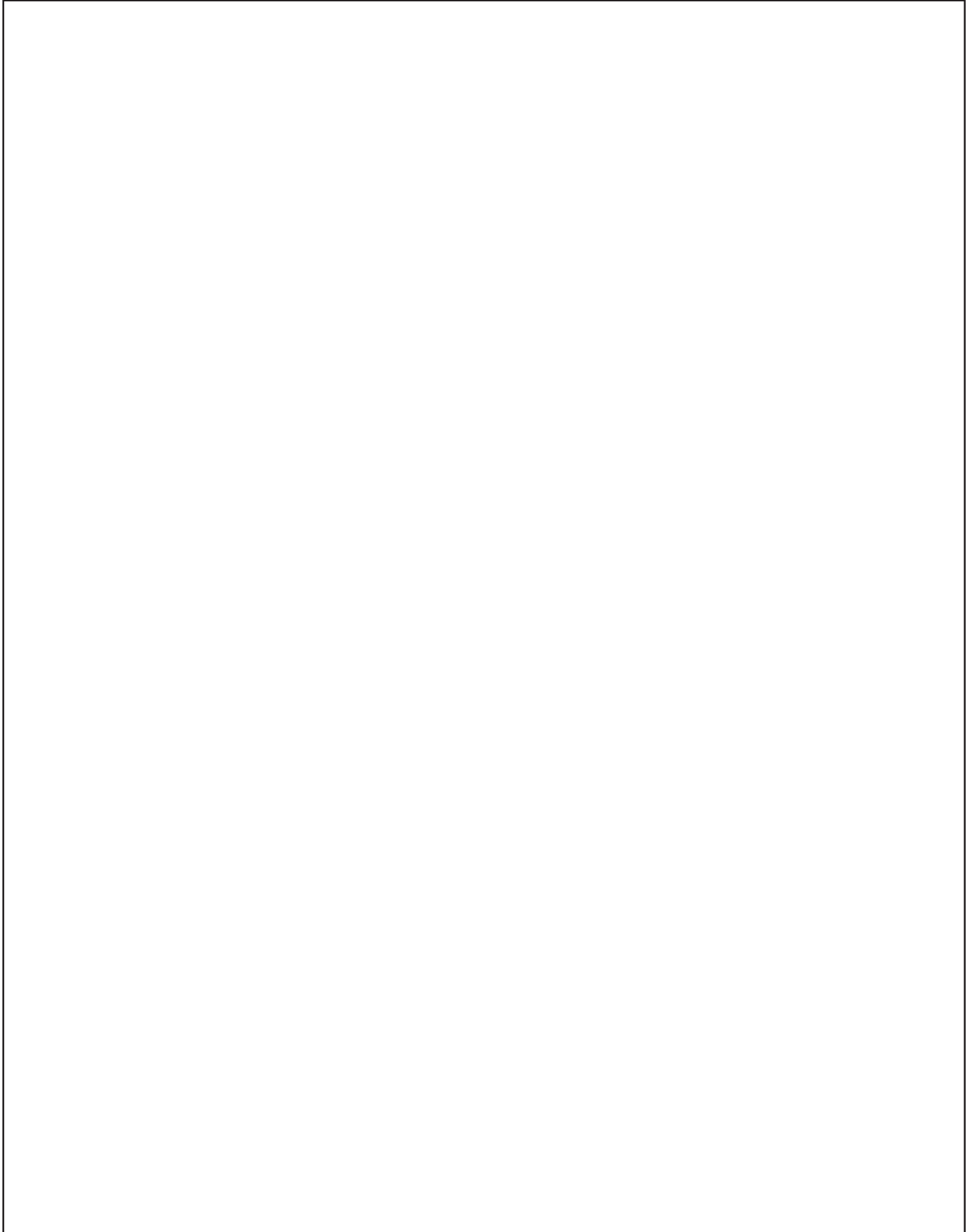

Wall units 579 mm,
height 01

Wall units 579 mm,
height 01



Wall units

579 mm high

Carcase depth 326 mm

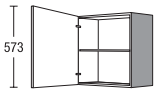
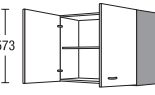
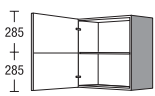
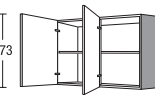
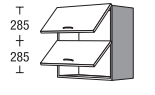
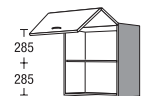
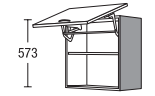
						Price group											
				width		1	2	3	4	5	6	7	Servosoft	Pro Servosoft	ProServoglass	Soft closing Top Motion	Soft closing Top Motion Plus
 <p>Wall unit 1 hinged door 1 adjustable shelf</p>		H	30	01		39	45	47	50	52	58	66	-	-	-	4	4
		H	40	01		44	48	50	53	57	62	68	-	-	-	4	4
		H	45	01		46	50	53	56	60	65	72	-	-	-	4	4
		H	50	01		48	52	55	58	62	68	75	-	-	-	4	4
		H	60	01		52	56	59	62	66	73	83	-	-	-	4	4
 <p>Wall unit 2 hinged doors 1 adjustable shelf</p>		H	80	01		69	75	79	83	95	106	121	-	-	-	8	8
		H	90	01		70	76	80	85	96	108	123	-	-	-	8	8
		H	100	01		72	79	84	90	101	112	126	-	-	-	8	8
 <p>Wall unit 1 door (dowelled) 1 adjustable shelf</p>		H	45	01	M2	48	52	55	58	62	67	74	-	-	-	4	4
		H	50	01	M2	50	54	57	60	64	70	77	-	-	-	4	4
		H	60	01	M2	55	59	62	65	69	76	86	-	-	-	4	4
 <p>Wall unit 2 doors, both hinged either left or right 1 adjustable shelf</p>		H	80	01	TP	72	78	82	86	98	109	124	-	-	-	8	8
		H	90	01	TP	73	79	84	89	99	111	126	-	-	-	8	8
		H	100	01	TP	75	82	87	93	104	115	129	-	-	-	8	8
 <p>Wall unit 2 flap doors 1 fixed shelf <i>Handle only fitted horizontally</i></p>		H2K	45	01		62	65	67	70	84	91	100	-	-	-	8	28
		H2K	50	01		62	65	68	73	83	89	98	-	-	-	8	28
		H2K	60	01		68	73	76	81	92	99	108	-	-	-	8	28
		H2K	80	01		74	79	83	88	100	107	117	-	-	-	8	28
		H2K	90	01		87	93	97	103	117	123	133	-	-	-	8	28
		H2K	100	01		90	96	100	105	119	124	135	-	-	-	8	28
 <p>Wall unit with upward folding door consisting of 2 fronts 1 adjustable shelf with pull-out safety device <i>Handle only fitted horizontally</i></p> <p><i>Folding door pivots approx. 140 mm upwards and 345 mm forwards from the upper front edge of the carcass.</i> <i>Upward lifting door takes up a minimum of space (depth) of 675 mm when open.</i></p> <p><i>Depending on the front weight, 1 or 2 energy-storage mechanisms are installed.</i></p>		HFK	45	01		85	90	93	95	98	104	113	-	-	-	-	-
		HFK	50	01		90	96	98	101	104	110	120	-	-	-	-	-
		HFK	60	01		109	116	119	122	126	133	145	-	-	-	-	-
		HFK	80	01		119	128	132	137	148	160	177	-	-	-	-	-
		HFK	90	01		123	132	136	141	152	164	181	-	-	-	-	-
		HFK	100	01		127	136	140	145	156	168	186	-	-	-	-	-
 <p>Wall unit with lift-up door 1 lift-up door with Softlift fitting 1 adjustable shelf with pull-out safety device <i>Handle only fitted horizontally</i></p> <p><i>Lift-up door swings up approx. 165 mm from the carcass top front edge and forward by 450 mm.</i></p>		HLK	60	01		121	125	128	131	135	142	154	-	-	-	-	-







Illustrations do not correspond to the door finishes.

3.15

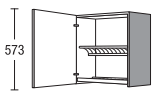
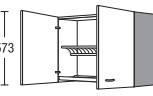
Wall units

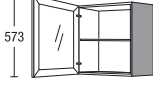
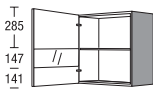
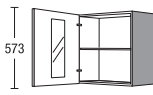
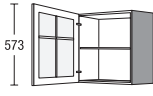
579 mm high

Carcase depth 326 mm



		width	Price group							Servosoft	Pro Servosoft	ProServoGlass	Soft closing Top Motion	Soft closing Top Motion Plus		
			1	2	3	4	5	6	7							
 <p>Wall unit with draining rack 1 hinged door 1 draining rack 1 storage rack 1 removable drip tray <i>Cannot be built-under.</i> <i>Load maximum 15 kg per shelf</i></p>	H	60	01	GT	99	103	106	109	113	120	132	-	-	-	4	4
 <p>Wall unit with draining rack 2 hinged doors 1 draining rack 1 storage rack 1 removable drip tray <i>Cannot be built-under.</i> <i>Load maximum 15 kg per shelf</i></p>	H	90	01	GT	122	128	132	137	148	160	177	-	-	-	8	8
 <p>Installation set unit with draining rack Consisting of: 1 draining rack 1 storage rack 1 removable drip tray <i>Load maximum 15 kg per shelf</i></p>	ZIH	60		IX	15	15	15	15	15	15	15	-	-	-	-	-
	ZIH	90		IX	19	19	19	19	19	19	19	-	-	-	-	-
 <p>Wall unit with glass door 1 glass door 1 adjustable glass shelf <i>Handles can only be mounted vertically on framed glass doors</i> <i>Handle can only be fitted horizontally on segment glass doors</i></p> <p>Framed glass door No. 701 <i>Assembly of handles nos. 740, 760, 780, 790 and 800 only horizontal, centred</i></p>  <p>Segmented glass door No. 706</p>  <p>Framed glass door No. 704</p>  <p>Glass door with glazing bars No. 705</p>	HG	45	01		76	80	81	83	90	96	103	-	-	-	4	4
	HG	50	01		78	82	83	85	92	98	107	-	-	-	4	4
	HG	60	01		82	86	87	89	96	104	114	-	-	-	4	4
	 HG	45	01	D	92	96	97	99	106	112	120	-	-	-	4	4
	 HG	50	01	D	94	98	99	101	108	114	123	-	-	-	4	4
	 HG	60	01	D	98	101	103	105	112	119	129	-	-	-	4	4

3.16 Illustrations do not correspond to the door finishes.

Wall units

579 mm high

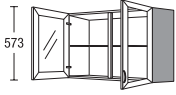
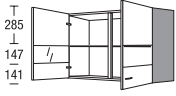
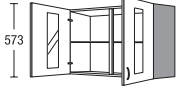
Carcase depth 326 mm





		width		Price group												
				1	2	3	4	5	6	7	Servosoft	Pro Servosoft	ProServoglass	Soft closing Top Motion	Soft closing Top Motion Plus	
 <p>573</p>	<p>Wall unit with glass doors</p> <p>2 glass doors 1 adjustable glass shelf</p> <p><i>Handles can only be mounted vertically on framed glass doors Handle can only be fitted horizontally on segment glass doors</i></p> <p>Framed glass door No. 701</p> <p><i>Assembly of handles nos. 740, 760, 780, 790 and 800 only horizontal, centred</i></p> <p><i>For glass and frame finishes please refer to programme summary</i></p>	HG	90	01	102	108	112	117	128	140	156	-	-	-	8	8
		HG	100	01	104	111	116	122	133	144	160	-	-	-	8	8
 <p>285 147 141</p>	<p>Segmented glass door No. 706</p>															
 <p>573</p>	<p>Framed glass door No. 704</p>															
 <p>573</p>	<p>Glass door with glazing bars No. 705</p>															

Illustrations do not correspond to the door finishes.

Wall units

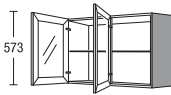
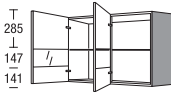
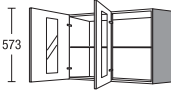
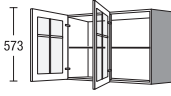
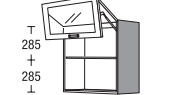
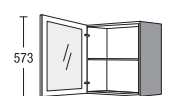
579 mm high

Carcase depth 326 mm



				width	Price group							Servosoft	Pro Servosoft	ProServoGlass	Soft closing Top Motion	Soft closing Top Motion Plus	
					1	2	3	4	5	6	7						
 <p>Wall unit with glass doors 2 glass doors hinged left or right 1 adjustable glass shelf</p> <p><i>Handles can only be mounted vertically on framed glass doors Handle can only be fitted horizontally on segment glass doors</i></p> <p>Framed glass door No. 701</p> <p><i>Assembly of handles nos. 740, 760, 780, 790 and 800 only horizontal, centred</i></p> <p><i>For glass and frame finishes please refer to programme summary</i></p>	HG	90	01	TP	105	111	115	120	131	143	160	-	-	-	8	8	
		HG	100	01	TP	107	114	119	125	136	147	163	-	-	-	8	8
 <p>Segmented glass door No. 706</p>																	
 <p>Framed glass door No. 704</p>																	
 <p>Glass door with glazing bars No. 705</p>																	
 <p>Wall unit with folding door with combined upward folding door consisting of 2 fronts top furniture door (in cabinet finish) framed glass door at bottom 2 adjustable glass shelves</p> <p><i>Handle only fitted horizontally</i></p> <p><i>Available for the following ranges: IP 1200, IP 2200, IP 3150, IP 4050</i></p> <p><i>Folding door pivots approx. 140 mm upwards and 345 mm forwards from the upper front edge of the carcass.</i> <i>Upward lifting door takes up a minimum of space (depth) of 675 mm when open.</i></p> <p><i>For glass and frame finishes please refer to programme summary</i></p>	HFKGU	50	01		142	146	149	153	162	166	178	-	-	-	-	-	
		HFKGU	60	01		147	151	154	158	167	172	185	-	-	-	-	-
		HFKGU	80	01		173	179	184	188	203	207	221	-	-	-	-	-
		HFKGU	90	01		177	183	188	192	207	212	226	-	-	-	-	-
		HFKGU	100	01		187	193	198	204	218	223	239	-	-	-	-	-
 <p>Wall unit with glass door 1 glass door (range-independent) 1 adjustable glass shelf</p> <p><i>Stainless steel look metal handle profile in the carcass base</i></p> <p>Type -N1</p> <p><i>For glass and frame finishes please refer to programme summary</i></p>	CHG	45	01	N1	110	110	110	110	110	110	110	-	-	-	4	4	
		CHG	50	01	N1	115	115	115	115	115	115	115	-	-	-	4	4
		CHG	60	01	N1	127	127	127	127	127	127	127	-	-	-	4	4
		 CHG	45	01	N1D	128	128	128	128	128	128	128	-	-	-	4	4
		 CHG	50	01	N1D	133	133	133	133	133	133	133	-	-	-	4	4
		 CHG	60	01	N1D	146	146	146	146	146	146	146	-	-	-	4	4

3.18 Illustrations do not correspond to the door finishes.

Wall units, Display wall units, Corner wall units

579 mm high

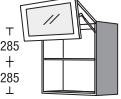
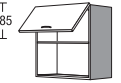
Carcase depth 326 mm

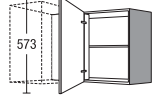
						Price group													
						width		1	2	3	4	5	6	7	Servosoft	Pro Servosoft	ProServoglass	Soft closing Top Motion	Soft closing Top Motion Plus
 <p>Wall unit with folding door</p> <p>with combined upward folding door consisting of 2 fronts top furniture door (in cabinet finish) framed glass door at bottom 2 adjustable glass shelves Carcase shelf with metal handle profile in stainless steel-effect</p> <p><i>Folding door pivots approx. 140 mm upwards and 345 mm forwards from the upper front edge of the carcass.</i></p> <p><i>Upward lifting door takes up a minimum of space (depth) of 675 mm when open.</i></p> <p><i>For glass and frame finishes please refer to programme summary</i></p>		CHFKGU	50	01	N1	167	171	173	177	185	188	200	-	-	-	-	-	-	
		CHFKGU	60	01	N1	175	178	180	184	192	197	208	-	-	-	-	-	-	
		CHFKGU	80	01	N1	205	210	215	218	231	235	248	-	-	-	-	-	-	
		CHFKGU	90	01	N1	210	216	219	224	237	241	255	-	-	-	-	-	-	
		CHFKGU	100	01	N1	221	227	231	236	249	254	268	-	-	-	-	-	-	
 <p>Wall unit</p> <p>1 flap door 1 open niche at bottom</p> <p>579 mm high</p> <p><i>Unit interior in carcass decor.</i></p> <p><i>Not available in visible side colours.</i></p>	D	HK	30	01	RU	66	69	72	75	81	92	106	-	-	-	4	14		
	D	HK	45	01	RU	72	75	78	81	86	96	110	-	-	-	4	14		
	D	HK	50	01	RU	74	78	81	85	91	102	116	-	-	-	4	14		
	D	HK	60	01	RU	78	83	87	91	98	108	123	-	-	-	4	14		
 <p>Display wall unit with unit door</p> <p>1 hinged door 1 adjustable shelf</p> <p>573</p>	V	VH	30	58		39	45	47	50	52	58	66	-	-	-	4	4		
	V	VH	40	58		44	48	50	53	57	62	68	-	-	-	4	4		
	V	VH	45	58		46	50	53	56	60	65	72	-	-	-	4	4		
	V	VH	50	58		48	52	55	58	62	68	75	-	-	-	4	4		
	V	VH	60	58		52	56	59	62	66	73	83	-	-	-	4	4		
 <p>Display wall unit with unit doors</p> <p>2 hinged doors 1 adjustable shelf</p> <p>573</p>	V	VH	80	58		66	72	76	80	92	103	118	-	-	-	8	8		
	V	VH	90	58		67	73	77	82	93	105	120	-	-	-	8	8		
	V	VH	100	58		69	76	81	87	98	109	123	-	-	-	8	8		
 <p>Corner wall unit</p> <p>1 hinged door 1 adjustable shelf</p> <p>573</p> <p>Version L</p> <p><i>HE 80 01: Planning dimension 800 x 350 mm to match UE 80, UE 80 KP, UE 80 K in combination with H 45 01</i></p> <p><i>HE 90 01: Planning dimension 900 x 400 mm to match UE 90, UE 90 KP, UE 90 K in combination with H 50 01</i></p>		HE	80	01		83	89	94	103	108	113	120	-	-	-	4	4		
		HE	90	01		87	94	98	111	116	121	128	-	-	-	4	4		

Illustrations do not correspond to the door finishes.

3.19

Corner wall units, Diagonal wall units

579 mm high

Carcase depth 326 mm

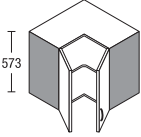
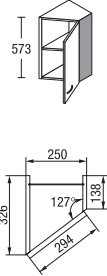
				Price group												
				width	1	2	3	4	5	6	7	Servosoft	Pro Servosoft	ProServoGlass	Soft closing Top Motion	Soft closing Top Motion Plus
 <p>Corner wall unit 2 hinged doors (opening angle approx. 170°) 1 adjustable shelf</p> <p><i>Handle only fitted vertically</i></p> <p><i>Assembly of handles nos. 740, 760, 780, 790 and 800 only horizontal, centred</i></p> <p><i>It is not possible to add a projecting extractor to the left or right side.</i></p> <p><i>HE 60 01: to match corner base units, planning dimensions 900 x 900 mm in conjunction with 2 x H 30 01</i></p> <p><i>HE 65 01: to match corner base units in planning dimension 1150 x 650 mm in conjunction with 1 x H 50 01</i></p> <p><i>The hinged doors must open to an angle of at least 100° (observe handle spacing).</i></p> <p><i>Buffer strip colour: Stainless-steel effect: for handle finish in stainless-steel effect Black: for all other handles finishes</i></p>	HE	60	01	112	120	129	138	141	150	163	-	-	-	8	8	
	HE	65	01	115	124	129	135	140	151	166	166	-	-	-	8	8
 <p>Diagonal wall unit 326/138 mm deep 1 hinged door 1 adjustable shelf</p>	HV	25	01	79	85	87	90	92	98	108	-	-	-	4	4	





3.20

Illustrations do not correspond to the door finishes.

Shelf units

579 mm high

Carcase depth 326 mm

				width	Price group							Servosoft	Pro Servosoft	ProServoglass	Soft closing Top Motion	Soft closing Top Motion Plus
					1	2	3	4	5	6	7					
 <p>579</p>	Wall open shelf unit		HR	30	01	50	50	50	50	50	50	-	-	-	-	-
	1 adjustable shelf		HR	45	01	54	54	54	54	54	54	-	-	-	-	-
	<i>Finish in carcase material</i>		HR	50	01	55	55	55	55	55	55	-	-	-	-	-
	<i>Not available in visible side colours.</i>		HR	60	01	57	57	57	57	57	57	-	-	-	-	-
 <p>579</p>	Wall open shelf unit		HR	V	01	73	73	73	73	73	73	-	-	-	-	-
	1 adjustable shelf															
<i>Finish in carcase material</i>																
<i>Please indicate desired width (150-600 mm).</i>																
<i>Shelves up to 250 mm wide without own suspension fitting</i>																
<i>Not available in visible side colours.</i>																
 <p>579</p>	Wall open shelf unit		HR	15	01	F	47	47	47	47	47	47	-	-	-	-
	4 compartments 3 fixed shelves															
<i>Finish in carcase material</i>																
<i>Shelf without own mounting fitting</i>																
<i>Not available in visible side colours.</i>																
 <p>579</p>	Angled open end shelf		HRA	25	01		43	43	43	43	43	43	-	-	-	-
	1 fixed shelf															
<i>Finish in carcase material</i>																
<i>can be used on both sides</i>																
<i>Shelf without own mounting fitting</i>																
<i>Not available in visible side colours.</i>																
Version R																
 <p>579</p>	Shelf end unit, angled		HRA	25	01	S	37	37	37	37	37	37	-	-	-	-
	1 fixed shelf															
<i>Finish in carcase material</i>																
<i>can be used on both sides</i>																
<i>Shelf without own mounting fitting</i>																
<i>Not available in visible side colours.</i>																
Version R																

Illustrations do not correspond to the door finishes.

3.21

Shelf units

579 mm high

Carcase depth 326 mm

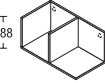
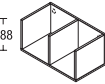
				width		Price group											
						1	2	3	4	5	6	7	Servosoft	Pro Servosoft	ProServoGlass	Soft closing Top Motion	Soft closing Top Motion Plus
 <p>Version R</p>	<p>Accent shelf end unit vertical</p> <p>1 fixed shelf</p> <p><i>Finish in carcase material</i></p> <p><i>Available in all carcase finishes.</i></p> <p><i>Additional colour variants:</i> 112 Cappuccino 121 Thyme 133 Volcano brown 134 Alby Blue 158 Sage green 952 Petrol</p> <p><i>Not available in visible side colours.</i></p>	HRA	30	01		76	76	76	76	76	76	76	-	-	-	-	-
	 <p>Version R</p>	<p>Accent shelf unit horizontal</p> <p>2 fixed dividers</p> <p><i>Finish in carcase material</i></p> <p><i>Available in all carcase finishes.</i></p> <p><i>Additional colour variants:</i> 112 Cappuccino 121 Thyme 133 Volcano brown 134 Alby Blue 158 Sage green 952 Petrol</p> <p><i>Not available in visible side colours.</i></p>	HR	60	29 2		68	68	68	68	68	68	68	-	-	-	-
 <p>Version R</p>	<p>Accent shelf unit horizontal</p> <p>3 fixed dividers</p> <p><i>Finish in carcase material</i></p> <p><i>Available in all carcase finishes.</i></p> <p><i>Additional colour variants:</i> 112 Cappuccino 121 Thyme 133 Volcano brown 134 Alby Blue 158 Sage green 952 Petrol</p> <p><i>Not available in visible side colours.</i></p>	HR	60	29 1		76	76	76	76	76	76	76	-	-	-	-	-

3.22 Illustrations do not correspond to the door finishes.

Shelf units

579 mm high

Carcase depth 326 mm

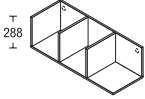
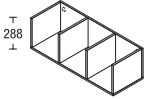
		width		Price group							Servosoft	Pro Servosoft	ProServoglass	Soft closing Top Motion	Soft closing Top Motion Plus		
				1	2	3	4	5	6	7							
 <p>Version R</p>	<p>Accent shelf unit horizontal</p> <p>3 fixed dividers</p> <p><i>Finish in carcass material</i></p> <p><i>Available in all carcass finishes.</i></p> <p><i>Additional colour variants:</i> 112 Cappuccino 121 Thyme 133 Volcano brown 134 Alby Blue 158 Sage green 952 Petrol</p> <p><i>Not available in visible side colours.</i></p>	HR	90	29	2	75	75	75	75	75	75	75	-	-	-	-	-
		<p>Accent shelf unit horizontal</p> <p>4 fixed dividers</p> <p><i>Finish in carcass material</i></p> <p><i>Available in all carcass finishes.</i></p> <p><i>Additional colour variants:</i> 112 Cappuccino 121 Thyme 133 Volcano brown 134 Alby Blue 158 Sage green 952 Petrol</p> <p><i>Not available in visible side colours.</i></p>	HR	90	29	1	83	83	83	83	83	83	83	-	-	-	-

Illustrations do not correspond to the door finishes.

Shelf units

579 mm high

Carcase depth 326 mm

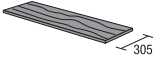
		width	Price group							Servosoft	Pro Servosoft	ProServoGlass	Soft closing Top Motion	Soft closing Top Motion Plus		
			1	2	3	4	5	6	7							
 <p>System shelf unit Set consisting of: 2 metal frames, black 2 shelves in carcase material, 305 mm deep</p> <p><i>High-gloss finish not available.</i></p> <p><i>Installation recommendation - projecting shelves:</i> 50 mm projection up to 450 mm shelf width 75 mm projection from 500 mm shelf width</p>	HR	30	01	TR	72	72	72	72	72	72	72	-	-	-	-	
	HR	40	01	TR	74	74	74	74	74	74	74	-	-	-	-	
	HR	45	01	TR	76	76	76	76	76	76	76	-	-	-	-	
	HR	50	01	TR	78	78	78	78	78	78	78	-	-	-	-	
	HR	60	01	TR	80	80	80	80	80	80	80	-	-	-	-	
	HR	80	01	TR	84	84	84	84	84	84	84	-	-	-	-	
	HR	90	01	TR	86	86	86	86	86	86	86	-	-	-	-	
	Individual frames for system shelf unit 1 metal frame, black <i>For individual design.</i> <i>We recommend the use of 3 frames for shelf widths above 900 mm.</i> <i>Installation recommendation - projecting shelves:</i> 50 mm projection up to 450 mm shelf width 75 mm projection from 500 mm shelf width <i>Order shelf RBxx (305 mm deep) separately!</i>	TRH	01		29	29	29	29	29	29	29	29	-	-	-	-
	 <p>Individual shelves for system shelf unit 1 shelf in carcase material, 305 mm deep <i>For individual design.</i> <i>Installation recommendation - projecting shelves:</i> 50 mm projection up to 450 mm shelf width 75 mm projection from 500 mm shelf width <i>Order frame TRHxx separately!</i></p>	RB	30		12	12	12	12	12	12	12	12	-	-	-	-
		RB	40		12	12	12	12	12	12	12	12	-	-	-	-
RB		45		12	12	12	12	12	12	12	12	-	-	-	-	
RB		50		12	12	12	12	12	12	12	12	-	-	-	-	
RB		60		13	13	13	13	13	13	13	13	-	-	-	-	
RB		80		15	15	15	15	15	15	15	15	-	-	-	-	
RB		90		16	16	16	16	16	16	16	16	-	-	-	-	

3.24 Illustrations do not correspond to the door finishes.

Filler panels

579 mm high

Carcase depth 326 mm

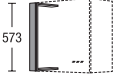
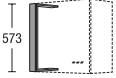
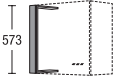
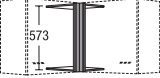
				Price group												
				width	1	2	3	4	5	6	7	Servosoft	Pro Servosoft	ProServoglass	Soft closing Top Motion	Soft closing Top Motion Plus
 <p>Infill panel for wall units for fitting between wall units</p> <p><i>Finish in door material with straight edge on both sides</i></p> <p><i>Some front edges in colour of carcass.</i></p> <p><i>Not available in visible side colours.</i></p>	HPF	10	01 Z	16	19	20	21	22	24	28	-	-	-	-	-	
	HPF	20	01 Z	25	28	30	32	34	37	41	-	-	-	-	-	
 <p>Infill panel for wall units Fitted between wall and carcass side</p> <p><i>Finish in door material without edging on the wall side</i></p> <p><i>Not available in visible side colours.</i></p> <p><i>Due to the installation angle, the maximum possible on-site width reduction is 46 mm.</i></p>	HPF	10	01	16	19	20	21	22	24	28	-	-	-	-	-	
	HPF	20	01	25	28	30	32	34	37	41	-	-	-	-	-	
 <p>Infill panel for wall units Finish in carcass material</p> <p><i>Not available in visible side colours.</i></p>	HPK	10	01	13	13	13	13	13	13	13	-	-	-	-	-	
	HPK	20	01	17	17	17	17	17	17	17	-	-	-	-	-	
	HPK	30	01	21	21	21	21	21	21	21	-	-	-	-	-	
 <p>Corner infill panel for wall units for 350 x 350 mm corner with top and base piece</p> <p><i>Finish in carcass material</i></p> <p><i>Not available in visible side colours.</i></p>	HPEK	35	01	23	23	23	23	23	23	23	-	-	-	-	-	

Illustrations do not correspond to the door finishes.

Filler panels

579 mm high

Carcase depth 326 mm

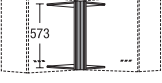
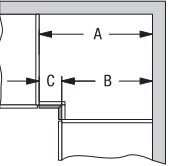
	width	Price group							Servosoft	Pro Servosoft	ProServoGlass	Soft closing Top Motion	Soft closing Top Motion Plus	
		1	2	3	4	5	6	7						
 <p>Corner infill panel for wall units with top and base piece</p> <p><i>Dimensions given are from one carcass corner to another</i></p> <p><i>Finish in door material</i></p>  <p><i>Leg dimensions of less than 36 mm width are manufactured from carcass material.</i></p> <p><i>Not available in visible side colours.</i></p> <p>Panel size in mm: A=B=C</p>	HPEF	43	01	43	46	48	50	51	52	56	-	-	-	-
	Total width 26 -100 mm													
	HPEF	53	01	55	58	60	63	64	69	75	-	-	-	-
	Leg width 26-191 mm													

Wall units 723 mm, height 02

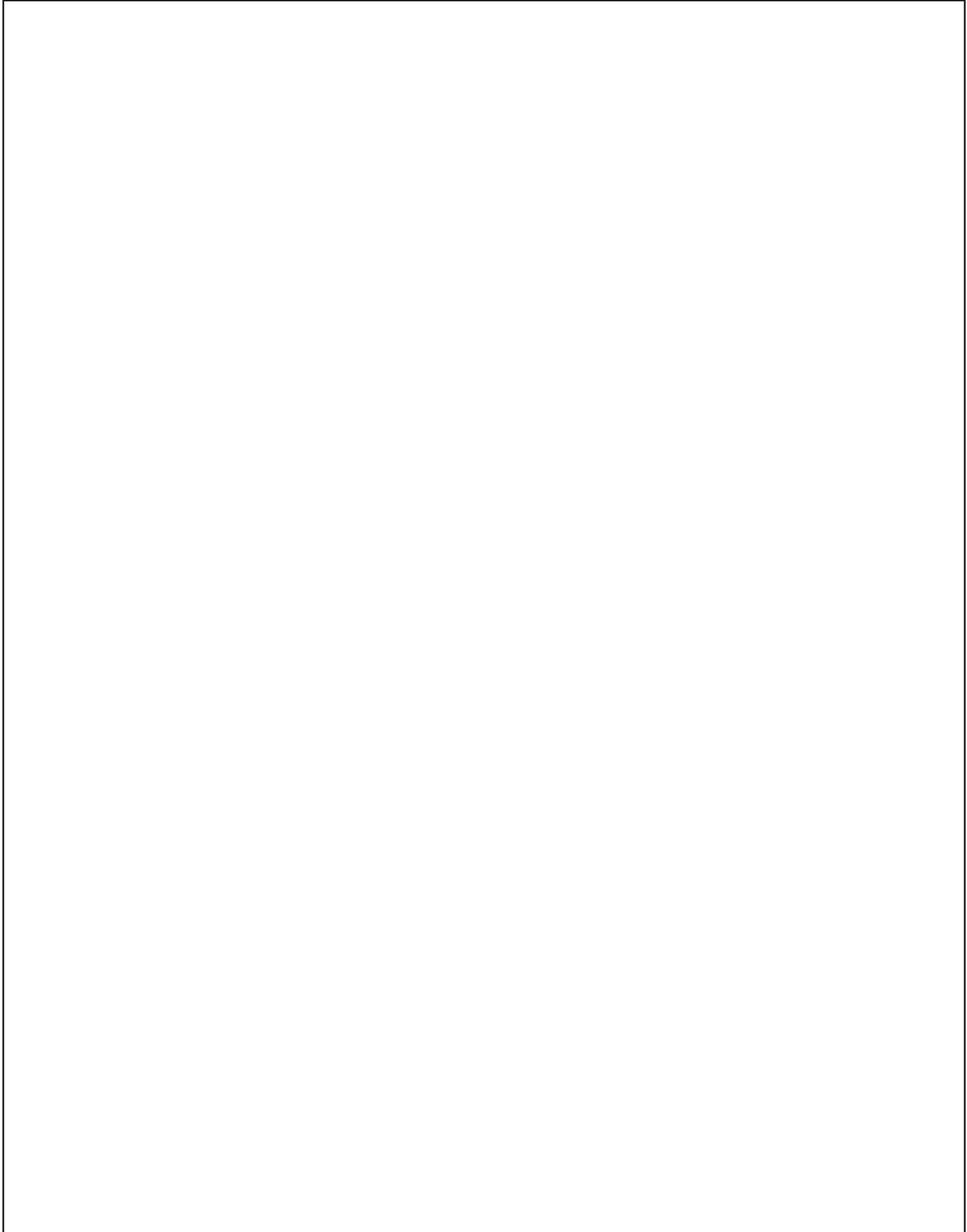

Wall units 723 mm,
height 02













Wall units 723 mm,
height 02



Wall units

723 mm high

Carcase depth 326 mm

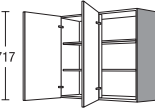
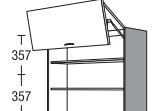
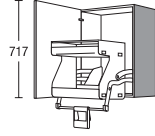
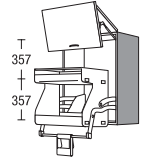





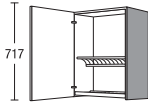
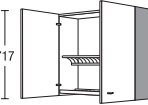

					Price group												
					width	1	2	3	4	5	6	7	Servosoft	Pro Servosoft	ProServoglass	Soft closing Top Motion	Soft closing Top Motion Plus
 <p>Wall unit 1 hinged door 2 adjustable shelves</p>		H	30	02		44	49	52	55	59	67	76	-	-	-	4	4
		H	40	02		49	53	56	59	64	71	80	-	-	-	4	4
		H	45	02		51	55	58	61	66	73	83	-	-	-	4	4
		H	50	02		53	57	60	64	70	78	88	-	-	-	4	4
		H	60	02		57	62	65	69	75	83	94	-	-	-	4	4
 <p>Wall unit 2 hinged doors 2 adjustable shelves</p>		H	80	02		77	83	88	94	109	123	141	-	-	-	8	8
		H	90	02		78	84	90	96	110	125	143	-	-	-	8	8
		H	100	02		81	87	93	100	114	128	146	-	-	-	8	8
 <p>Wall unit 2 doors, both hinged either left or right 2 adjustable shelves</p>		H	80	02	TP	80	86	91	97	112	126	144	-	-	-	8	8
		H	90	02	TP	81	87	93	99	113	128	146	-	-	-	8	8
		H	100	02	TP	84	90	96	103	117	131	149	-	-	-	8	8
 <p>Wall unit with upward folding door consisting of 2 fronts 2 adjustable shelves with pull-out safety device</p> <p><i>Handle only fitted horizontally</i></p> <p><i>Folding door pivots approx. 205 mm upwards and 440 mm forwards from the upper front edge of the carcass.</i></p> <p><i>Upward lifting door takes up a minimum of space (depth) of 770 mm when open.</i></p>		HFK	50	02		120	127	130	132	136	143	155	-	-	-	-	-
		HFK	60	02		126	133	136	139	143	150	163	-	-	-	-	-
		HFK	80	02		132	142	147	152	164	179	199	-	-	-	-	-
		HFK	90	02		140	151	156	161	174	190	212	-	-	-	-	-
		HFK	100	02		148	160	165	170	184	201	225	-	-	-	-	-
 <p>iMove wall unit 1 hinged door 1 iMove fitting with lowerable double level max. load capacity 8 kg</p> <p><i>The hinged doors must open to an angle of at least 90° (observe handle spacing).</i></p>		H	60	02	IM2	225	244	255	273	299	325	354	-	-	-	4	4
 <p>iMove wall unit with upward folding door consisting of 2 fronts 1 iMove fitting with lowerable double level max. load capacity 8 kg</p> <p><i>Handle only fitted horizontally</i></p> <p><i>Folding door pivots approx. 205 mm upwards and 440 mm forwards from the upper front edge of the carcass.</i></p> <p><i>Upward lifting door takes up a minimum of space (depth) of 770 mm when open.</i></p>		HFK	60	02	IM2	280	303	317	340	372	404	440	-	-	-	-	-

Illustrations do not correspond to the door finishes.

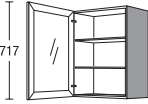
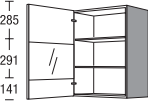
Wall units

723 mm high



Carcase depth 326 mm

		width	Price group							Servosoft	Pro Servosoft	ProServoGlass	Soft closing Top Motion	Soft closing Top Motion Plus		
			1	2	3	4	5	6	7							
 <p>Wall unit with draining rack 1 hinged door 1 draining rack 1 storage rack 1 removable drip tray <i>Cannot be built-under.</i> <i>Load maximum 15 kg per shelf</i></p>	H	60	02	GT	104	109	112	116	122	130	143	-	-	-	4	4
 <p>Wall unit with draining rack 2 hinged doors 1 draining rack 1 storage rack 1 removable drip tray <i>Cannot be built-under.</i> <i>Load maximum 15 kg per shelf</i></p>	H	90	02	GT	130	136	142	148	162	177	197	-	-	-	8	8
 <p>Installation set unit with draining rack Consisting of: 1 draining rack 1 storage rack 1 removable drip tray <i>Load maximum 15 kg per shelf</i></p>	ZIH	60		IX	15	15	15	15	15	15	15	-	-	-	-	-
	ZIH	90		IX	19	19	19	19	19	19	19	-	-	-	-	-
 <p>Wall unit with glass door 1 glass door 2 adjustable glass shelves <i>Handles can only be mounted vertically on framed glass doors</i> <i>Handle can only be fitted horizontally on segment glass doors</i></p> <p>Framed glass door No. 701 <i>Assembly of handles nos. 740, 760, 780, 790 and 800 only horizontal, centred</i></p>  <p>Segmented glass door No. 706</p>  <p>Framed glass door No. 704</p>  <p>Glass door with glazing bars No. 705</p>	HG	45	02		85	89	90	92	100	108	118	-	-	-	4	4
	HG	50	02		87	91	92	94	103	111	122	-	-	-	4	4
	HG	60	02		90	95	97	99	108	117	128	-	-	-	4	4
	 HG	45	02	D	99	103	105	107	115	123	134	-	-	-	4	4
	 HG	50	02	D	101	105	107	110	118	127	139	-	-	-	4	4
	 HG	60	02	D	105	109	111	114	124	133	144	-	-	-	4	4

Wall units

723 mm high

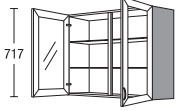
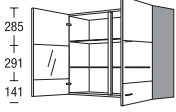
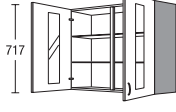
Carcase depth 326 mm

			Price group												
			width	1	2	3	4	5	6	7	Servosoft	Pro Servosoft	ProServoglass	Soft closing Top Motion	Soft closing Top Motion Plus
 <p>Framed glass door No. 701</p>	Wall unit with glass doors			HG 90 02	110	116	122	128	142	157	176	-	-	-	8
	<p>2 glass doors 2 adjustable glass shelves</p> <p><i>Handles can only be mounted vertically on framed glass doors Handle can only be fitted horizontally on segment glass doors</i></p> <p><i>Assembly of handles nos. 740, 760, 780, 790 and 800 only horizontal, centred</i></p> <p><i>For glass and frame finishes please refer to programme summary</i></p>		HG 100 02	113	119	125	132	146	160	179	-	-	-	8	8
 <p>Segmented glass door No. 706</p>															
 <p>Framed glass door No. 704</p>															
 <p>Glass door with glazing bars No. 705</p>															





Illustrations do not correspond to the door finishes.

3.29

Wall units

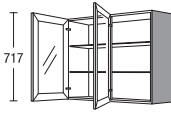
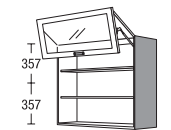
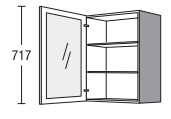
723 mm high





Carcase depth 326 mm

				width	Price group							Servosoft	Pro Servosoft	ProServoGlass	Soft closing Top Motion	Soft closing Top Motion Plus	
					1	2	3	4	5	6	7						
 <p>Wall unit with glass doors 2 glass doors hinged left or right 2 adjustable glass shelves</p> <p><i>Handles can only be mounted vertically on framed glass doors Handle can only be fitted horizontally on segment glass doors</i></p> <p>Framed glass door No. 701</p> <p><i>Assembly of handles nos. 740, 760, 780, 790 and 800 only horizontal, centred</i></p> <p>Segmented glass door No. 706</p> <p>Framed glass door No. 704</p> <p>Glass door with glazing bars No. 705</p>	HG	90	02	TP	113	119	125	131	145	160	179	-	-	-	8	8	
	HG	100	02	TP	116	122	128	135	149	163	182	-	-	-	8	8	
 <p>Wall unit with folding door with combined upward folding door consisting of 2 fronts top furniture door (in cabinet finish) framed glass door at bottom 2 adjustable glass shelves</p> <p><i>Handle only fitted horizontally</i></p> <p>Framed glass door No. 711</p> <p><i>Available for the following ranges: IP 1200, IP 2200, IP 3150, IP 4050</i></p> <p><i>Folding door pivots approx. 205 mm upwards and 440 mm forwards from the upper front edge of the carcass.</i> <i>Upward lifting door takes up a minimum of space (depth) of 770 mm when open.</i></p> <p><i>For glass and frame finishes please refer to programme summary</i></p>	HFKGU	50	02		148	152	155	159	169	173	186	-	-	-	-	-	
	HFKGU	60	02		151	155	158	162	172	177	190	-	-	-	-	-	
	HFKGU	80	02		175	181	186	190	205	209	224	-	-	-	-	-	
	HFKGU	90	02		183	189	194	199	214	219	234	-	-	-	-	-	
	HFKGU	100	02		190	196	201	207	222	227	243	-	-	-	-	-	
 <p>Wall unit with glass door 1 glass door (range-independent) 2 adjustable glass shelves</p> <p>Type -N1</p> <p><i>Stainless steel look metal handle profile in the carcass base</i></p> <p><i>For glass and frame finishes please refer to programme summary</i></p>	CHG	45	02	N1	122	122	122	122	122	122	122	-	-	-	4	4	
	CHG	50	02	N1	127	127	127	127	127	127	127	-	-	-	4	4	
	CHG	60	02	N1	141	141	141	141	141	141	141	-	-	-	4	4	
		CHG	45	02	N1D	144	144	144	144	144	144	144	-	-	-	4	4
		CHG	50	02	N1D	149	149	149	149	149	149	149	-	-	-	4	4
		CHG	60	02	N1D	164	164	164	164	164	164	164	-	-	-	4	4

Wall units, Display wall units

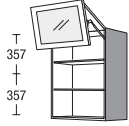
723 mm high

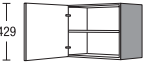
Carcase depth 326 mm

						Price group											
				width		1	2	3	4	5	6	7	Servosoft	Pro Servosoft	ProServoglass	Soft closing Top Motion	Soft closing Top Motion Plus
 <p>Wall unit with folding door</p> <p>with combined upward folding door consisting of 2 fronts top furniture door (in cabinet finish) framed glass door at bottom 2 adjustable glass shelves Carcase shelf with metal handle profile in stainless steel-effect</p> <p><i>Folding door pivots approx. 205 mm upwards and 440 mm forwards from the upper front edge of the carcase.</i></p> <p><i>Upward lifting door takes up a minimum of space (depth) of 770 mm when open.</i></p> <p><i>For glass and frame finishes please refer to programme summary</i></p>		CHFKGU	50	02	N1	182	186	188	192	200	205	217	-	-	-	-	-
		CHFKGU	60	02	N1	191	195	197	201	210	215	227	-	-	-	-	-
		CHFKGU	80	02	N1	213	218	223	227	240	244	258	-	-	-	-	-
		CHFKGU	90	02	N1	223	228	233	238	251	256	270	-	-	-	-	-
		CHFKGU	100	02	N1	231	237	241	246	260	265	279	-	-	-	-	-
 <p>Wall unit</p> <p>1 flap door 1 open niche at bottom</p> <p>723 mm high</p> <p><i>Unit interior in carcase decor.</i></p> <p><i>Not available in visible side colours.</i></p>	D	HK	30	02	RU	71	74	78	80	87	99	114	-	-	-	4	14
	D	HK	45	02	RU	79	83	86	89	94	106	121	-	-	-	4	14
	D	HK	50	02	RU	81	85	89	93	99	112	127	-	-	-	4	14
	D	HK	60	02	RU	84	90	94	98	105	117	132	-	-	-	4	14
 <p>Wall unit</p> <p>435 mm high above cooker hoods in combination with height 02 1 hinged door 1 adjustable shelf</p> <p><i>Not available in visible side colours.</i></p>		H	60	43		47	50	53	56	66	71	78	-	-	-	4	4
 <p>Display wall unit with unit door</p> <p>1 hinged door 2 adjustable shelves</p>	V	VH	30	72		44	49	52	55	59	67	76	-	-	-	4	4
	V	VH	40	72		49	53	56	59	64	71	80	-	-	-	4	4
	V	VH	45	72		51	55	58	61	66	73	83	-	-	-	4	4
	V	VH	50	72		53	57	60	64	70	78	88	-	-	-	4	4
 <p>Display wall unit with unit doors</p> <p>2 hinged doors 2 adjustable shelves</p>	V	VH	80	72		74	80	85	91	106	120	138	-	-	-	8	8
	V	VH	90	72		85	91	97	103	117	132	150	-	-	-	8	8
	V	VH	100	72		88	94	100	107	121	135	153	-	-	-	8	8

Illustrations do not correspond to the door finishes.

3.31

Corner wall units, Diagonal wall units

723 mm high

Carcase depth 326 mm

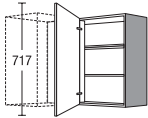
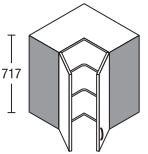
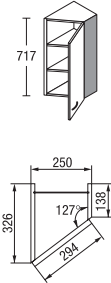
		width	Price group							Servosoft	Pro Servosoft	ProServoGlass	Soft closing Top Motion	Soft closing Top Motion Plus	
			1	2	3	4	5	6	7						
 <p>Corner wall unit 1 hinged door 2 adjustable shelves</p> <p><i>HE 80 02:</i> Planning dimension 800 x 350 mm to match UE 80, UE 80 KP, UE 80 K in combination with H 45 02</p> <p><i>HE 90 02:</i> Planning dimension 900 x 400 mm to match UE 90, UE 90 KP, UE 90 K in combination with H 50 02</p> <p>Version L</p>	HE	80	02	94	99	104	112	116	124	134	-	-	-	4	4
	HE	90	02	97	102	108	118	122	130	140	-	-	-	4	4
 <p>Corner wall unit 2 hinged doors (opening angle approx. 170°) 2 adjustable shelves</p> <p><i>Handle only fitted vertically</i></p> <p><i>Assembly of handles nos. 740, 760, 780, 790 and 800 only horizontal, centred</i></p> <p><i>It is not possible to add a projecting extractor to the left or right side.</i></p> <p><i>HE 60 02:</i> to match corner base units, planning dimensions 900 x 900 mm in conjunction with 2 x H 30 02</p> <p><i>HE 65 02:</i> to match corner base units in planning dimension 1150 x 650 mm in conjunction with 1 x H 50 02</p> <p><i>The hinged doors must open to an angle of at least 100° (observe handle spacing).</i></p> <p><i>Buffer strip colour:</i> Stainless-steel effect: for handle finish in stainless-steel effect Black: for all other handles finishes</p>	HE	60	02	125	135	143	151	158	169	186	-	-	-	8	8
	HE	65	02	128	140	146	153	162	175	195	-	-	-	8	8
 <p>Diagonal wall unit 326/138 mm deep 1 hinged door 2 adjustable shelves</p>	HV	25	02	92	97	100	103	107	115	126	-	-	-	4	4



3.32

Illustrations do not correspond to the door finishes.

Shelf units

723 mm high

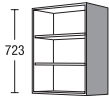
Carcase depth 326 mm

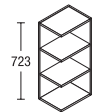
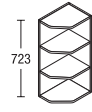

		width		Price group							Servosoft	Pro Servosoft	ProServoglass	Soft closing Top Motion	Soft closing Top Motion Plus
				1	2	3	4	5	6	7					
 <p>Wall open shelf unit 2 adjustable shelves <i>Finish in carcase material</i> <i>Not available in visible side colours.</i></p>	HR	30	02	57	57	57	57	57	57	57	-	-	-	-	-
	HR	45	02	60	60	60	60	60	60	60	-	-	-	-	-
	HR	50	02	61	61	61	61	61	61	61	-	-	-	-	-
	HR	60	02	63	63	63	63	63	63	63	-	-	-	-	-
 <p>Wall open shelf unit 2 adjustable shelves <i>Finish in carcase material</i> <i>Please indicate desired width (150-600 mm).</i> <i>Shelves up to 250 mm wide without own suspension fitting</i> <i>Not available in visible side colours.</i></p>	HR	V	02	79	79	79	79	79	79	79	-	-	-	-	-
 <p>Wall open shelf unit 5 compartments 4 fixed shelves <i>Finish in carcase material</i> <i>Shelf without own mounting fitting</i> <i>Not available in visible side colours.</i></p>	HR	15	02	F	54	54	54	54	54	54	-	-	-	-	-
 <p>Angled open end shelf 2 fixed shelves <i>Finish in carcase material</i> <i>can be used on both sides</i> <i>Shelf without own mounting fitting</i> <i>Not available in visible side colours.</i></p> <p>Version R</p>	HRA	25	02	52	52	52	52	52	52	52	-	-	-	-	-
 <p>Shelf end unit, angled 2 fixed shelves <i>Finish in carcase material</i> <i>can be used on both sides</i> <i>Shelf without own mounting fitting</i> <i>Not available in visible side colours.</i></p> <p>Version R</p>	HRA	25	02	S	44	44	44	44	44	44	-	-	-	-	-

Illustrations do not correspond to the door finishes.

Shelf units

723 mm high

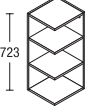
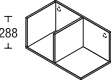
Carcase depth 326 mm



			width	Price group							Servosoft	Pro Servosoft	ProServoGlass	Soft closing Top Motion	Soft closing Top Motion Plus	
				1	2	3	4	5	6	7						
 <p>Version R</p>	<p>Accent shelf end unit vertical</p> <p>2 fixed shelves</p> <p><i>Finish in carcase material</i></p> <p><i>Available in all carcase finishes.</i></p> <p><i>Additional colour variants:</i> 112 Cappuccino 121 Thyme 133 Volcano brown 134 Alby Blue 158 Sage green 952 Petrol</p> <p><i>Not available in visible side colours.</i></p>	HRA	30	02	78	78	78	78	78	78	78	-	-	-	-	-
 <p>Version R</p>	<p>Accent shelf unit horizontal</p> <p>2 fixed dividers</p> <p><i>Finish in carcase material</i></p> <p><i>Available in all carcase finishes.</i></p> <p><i>Additional colour variants:</i> 112 Cappuccino 121 Thyme 133 Volcano brown 134 Alby Blue 158 Sage green 952 Petrol</p> <p><i>Not available in visible side colours.</i></p>	HR	60	29 2	68	68	68	68	68	68	68	-	-	-	-	-
 <p>Version R</p>	<p>Accent shelf unit horizontal</p> <p>3 fixed dividers</p> <p><i>Finish in carcase material</i></p> <p><i>Available in all carcase finishes.</i></p> <p><i>Additional colour variants:</i> 112 Cappuccino 121 Thyme 133 Volcano brown 134 Alby Blue 158 Sage green 952 Petrol</p> <p><i>Not available in visible side colours.</i></p>	HR	60	29 1	76	76	76	76	76	76	76	-	-	-	-	-

3.34 Illustrations do not correspond to the door finishes.

Shelf units

723 mm high

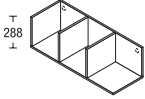
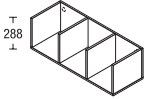
Carcase depth 326 mm

						Price group												
		width				1	2	3	4	5	6	7	Servosoft	Pro Servosoft	ProServoglass	Soft closing Top Motion	Soft closing Top Motion Plus	
 <p>Version R</p>	<p>Accent shelf unit horizontal</p> <p>3 fixed dividers</p> <p><i>Finish in carcass material</i></p> <p><i>Available in all carcass finishes.</i></p> <p><i>Additional colour variants:</i> 112 Cappuccino 121 Thyme 133 Volcano brown 134 Alby Blue 158 Sage green 952 Petrol</p> <p><i>Not available in visible side colours.</i></p>	HR	90	29	2	75	75	75	75	75	75	75	-	-	-	-	-	
		<p>Accent shelf unit horizontal</p> <p>4 fixed dividers</p> <p><i>Finish in carcass material</i></p> <p><i>Available in all carcass finishes.</i></p> <p><i>Additional colour variants:</i> 112 Cappuccino 121 Thyme 133 Volcano brown 134 Alby Blue 158 Sage green 952 Petrol</p> <p><i>Not available in visible side colours.</i></p>	HR	90	29	1	83	83	83	83	83	83	83	-	-	-	-	-
	<p>System shelf unit</p> <p>Set consisting of: 2 metal frames, black 2 shelves in carcass material, 305 mm deep</p> <p><i>High-gloss finish not available.</i></p> <p><i>Installation recommendation - projecting shelves:</i> 50 mm projection up to 450 mm shelf width 75 mm projection from 500 mm shelf width</p>	HR	30	02	TR	77	77	77	77	77	77	77	-	-	-	-	-	
		HR	40	02	TR	79	79	79	79	79	79	79	79	-	-	-	-	-
		HR	45	02	TR	81	81	81	81	81	81	81	81	-	-	-	-	-
		HR	50	02	TR	83	83	83	83	83	83	83	83	-	-	-	-	-
		HR	60	02	TR	86	86	86	86	86	86	86	86	-	-	-	-	-
		HR	80	02	TR	90	90	90	90	90	90	90	90	-	-	-	-	-
		HR	90	02	TR	92	92	92	92	92	92	92	92	-	-	-	-	-
		TRH	02			32	32	32	32	32	32	32	32	-	-	-	-	-
	<p>Individual frames for system shelf unit</p> <p>1 metal frame, black</p> <p><i>For individual design.</i></p> <p><i>We recommend the use of 3 frames for shelf widths above 900 mm.</i></p> <p><i>Installation recommendation - projecting shelves:</i> 50 mm projection up to 450 mm shelf width 75 mm projection from 500 mm shelf width</p> <p><i>Order shelf RBxx (305 mm deep) separately!</i></p>																	

Illustrations do not correspond to the door finishes.

3.35

Shelf units

723 mm high

Carcase depth 326 mm

		width	Price group							Servosoft	Pro-Servosoft	ProServoGlass	Soft closing Top Motion	Soft closing Top Motion Plus
			1	2	3	4	5	6	7					
 <p>Individual shelves for system shelf unit</p> <p>1 shelf in carcase material, 305 mm deep</p> <p><i>For individual design.</i></p> <p><i>Installation recommendation - projecting shelves:</i></p> <p><i>50 mm projection up to 450 mm shelf width</i> <i>75 mm projection from 500 mm shelf width</i></p> <p><i>Order frame TRHxx separately!</i></p>	RB	30	12	12	12	12	12	12	12	-	-	-	-	-
	RB	40	12	12	12	12	12	12	12	-	-	-	-	-
	RB	45	12	12	12	12	12	12	12	-	-	-	-	-
	RB	50	12	12	12	12	12	12	12	-	-	-	-	-
	RB	60	13	13	13	13	13	13	13	-	-	-	-	-
	RB	80	15	15	15	15	15	15	15	-	-	-	-	-
	RB	90	16	16	16	16	16	16	16	-	-	-	-	-

3.36 Illustrations do not correspond to the door finishes.

Filler panels

723 mm high

Carcase depth 326 mm

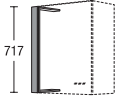
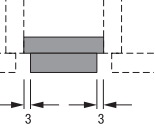
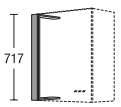
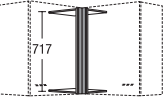
				Price group													
				width	1	2	3	4	5	6	7	Servosoft	Pro Servosoft	ProServoglass	Soft closing Top Motion	Soft closing Top Motion Plus	
 <p>Infill panel for wall units for fitting between wall units</p> <p><i>Finish in door material with straight edge on both sides</i></p> <p><i>Some front edges in colour of carcass.</i></p> <p><i>Not available in visible side colours.</i></p>	HPF	10	02	Z	19	22	23	24	25	27	31	-	-	-	-	-	
	-	HPF	20	02	Z	30	33	35	37	39	41	44	-	-	-	-	-
	-	-	-	-	-	-	-	-	-	-	-	-	-	-	-	-	-
 <p>Infill panel for wall units Fitted between wall and carcass side</p> <p><i>Finish in door material without edging on the wall side</i></p> <p><i>Not available in visible side colours.</i></p> <p><i>Due to the installation angle, the maximum possible on-site width reduction is 46 mm.</i></p>	HPF	10	02		19	22	23	24	25	27	31	-	-	-	-	-	
	HPF	20	02		30	33	35	37	39	41	44	-	-	-	-	-	
	-	-	-	-	-	-	-	-	-	-	-	-	-	-	-	-	-
 <p>Infill panel for wall units <i>Finish in carcass material</i></p> <p><i>Not available in visible side colours.</i></p>	HPK	10	02		14	14	14	14	14	14	14	-	-	-	-	-	
	HPK	20	02		18	18	18	18	18	18	18	-	-	-	-	-	
	HPK	30	02		22	22	22	22	22	22	22	-	-	-	-	-	
 <p>Corner infill panel for wall units for 350 x 350 mm corner with top and base piece</p> <p><i>Finish in carcass material</i></p> <p><i>Not available in visible side colours.</i></p>	HPEK	35	02		25	25	25	25	25	25	25	-	-	-	-	-	

Illustrations do not correspond to the door finishes.

Filler panels

723 mm high

Carcase depth 326 mm

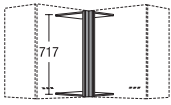
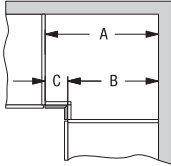
		width	Price group							Servosoft	Pro Servosoft	ProServoGlass	Soft closing Top Motion	Soft closing Top Motion Plus
			1	2	3	4	5	6	7					
 <p>Corner infill panel for wall units with top and base piece</p> <p><i>Dimensions given are from one carcass corner to another</i> <i>Finish in door material</i></p> <p><i>Leg dimensions of less than 36 mm width are manufactured from carcass material.</i></p> <p><i>Not available in visible side colours.</i></p>  <p>Panel size in mm: A=B=C</p>	HPEF	43	02	50	53	55	57	58	59	63	-	-	-	-
	Total width 26 -100 mm													
	HPEF	53	02	55	58	60	63	64	69	75	-	-	-	-
	Leg width 26-191 mm													

Wall units 867 mm, height 03

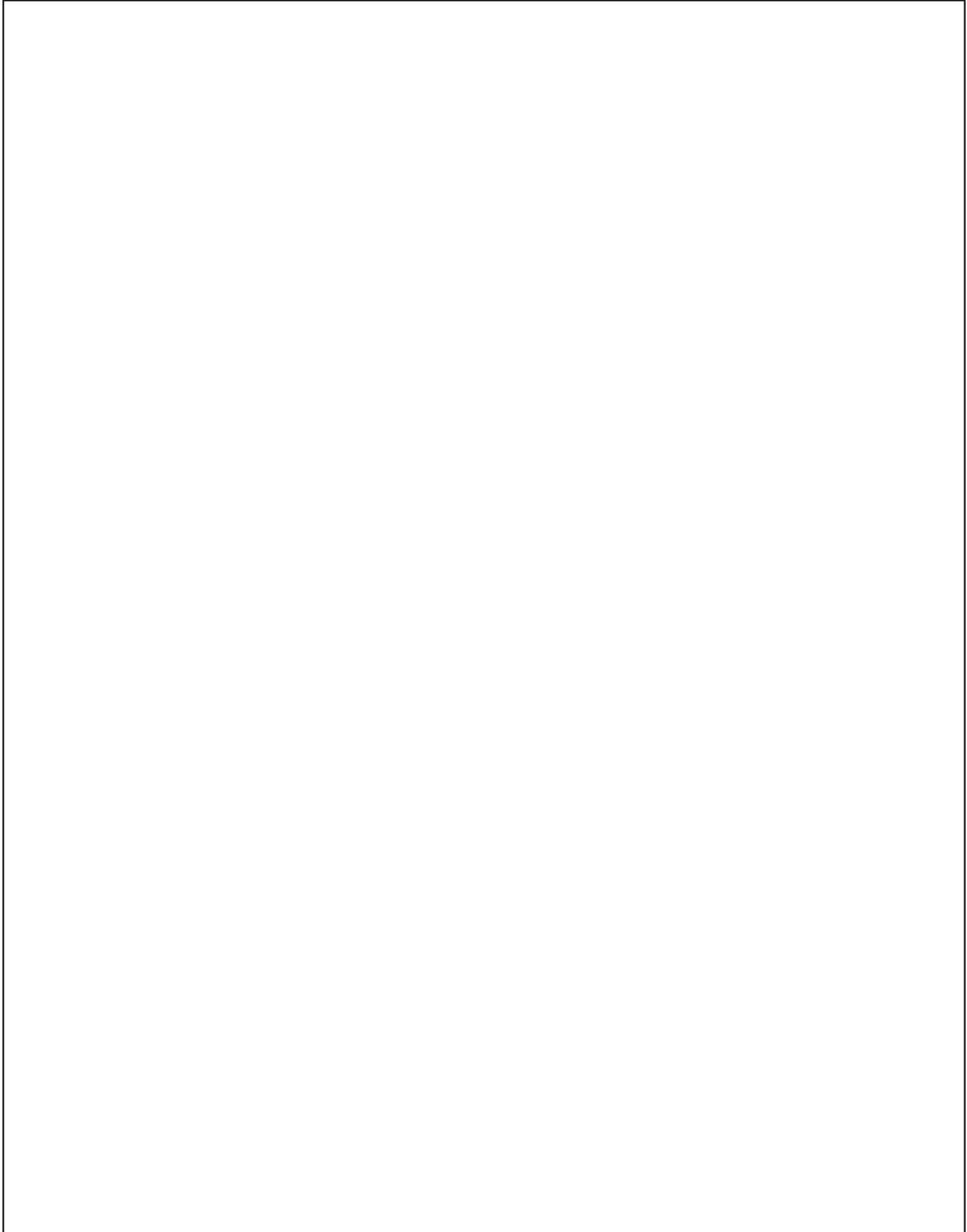

Wall units 867 mm,
height 03











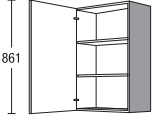





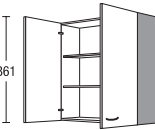

Wall units 867 mm,
height 03

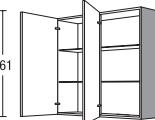
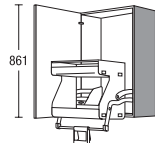
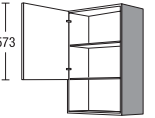

Wall units

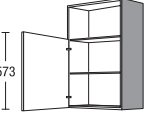
867 mm high

Carcase depth 326 mm

		width		Price group							Servosoft	Pro Servosoft	ProServoglass	Soft closing Top Motion	Soft closing Top Motion Plus		
				1	2	3	4	5	6	7							
 <p>Wall unit 1 hinged door 2 adjustable shelves</p>		H	30	03	47	50	53	57	64	73	85	-	-	-	4	4	
		H	40	03	52	56	59	62	68	77	89	-	-	-	4	4	
		H	45	03	54	58	61	64	70	79	91	-	-	-	4	4	
		H	50	03	56	60	64	68	75	85	97	-	-	-	4	4	
		H	60	03	59	65	69	73	81	90	102	-	-	-	4	4	
		H	30	03	E	54	57	60	64	71	80	92	-	-	-	4	4
		H	40	03	E	59	63	66	69	75	84	96	-	-	-	4	4
		H	45	03	E	61	65	68	71	77	86	98	-	-	-	4	4
		H	50	03	E	63	67	71	75	82	92	104	-	-	-	4	4
		H	60	03	E	66	72	76	80	88	97	110	-	-	-	4	4
 <p>Wall unit 2 hinged doors 2 adjustable shelves</p>		H	80	03	81	87	93	100	118	135	156	-	-	-	8	8	
		H	90	03	82	88	95	102	120	137	159	-	-	-	8	8	
		H	100	03	85	91	98	105	123	140	162	-	-	-	8	8	
		H	80	03	E	88	94	101	108	125	142	164	-	-	-	8	8
		H	90	03	E	89	95	102	109	127	144	166	-	-	-	8	8
		H	100	03	E	92	98	105	112	130	147	169	-	-	-	8	8
 <p>Wall unit 2 doors, both hinged either left or right 2 adjustable shelves</p>		H	80	03	TP	84	90	96	103	121	138	160	-	-	-	8	8
		H	90	03	TP	85	91	98	105	123	140	162	-	-	-	8	8
		H	100	03	TP	88	94	101	108	126	143	165	-	-	-	8	8
 <p>iMove wall unit 1 hinged door 1 iMove fitting with lowerable double level max. load capacity 8 kg <i>The hinged doors must open to an angle of at least 90° (observe handle spacing).</i></p>		H	60	03	IM2	231	250	262	281	307	334	363	-	-	-	4	4
 <p>Wall unit 1 hinged door 1 adjustable shelf 1 open niche at bottom <i>Unit interior in carcass decor.</i> <i>Not available in visible side colours.</i></p>		H	30	03	RU	72	75	79	82	89	102	118	-	-	-	4	4
		H	45	03	RU	79	83	86	89	95	107	123	-	-	-	4	4
		H	50	03	RU	81	85	89	93	100	113	129	-	-	-	4	4
		H	60	03	RU	84	90	94	98	106	118	134	-	-	-	4	4
 <p>Wall unit unit interior in carcass finish 1 open niche at top 1 hinged door 1 adjustable shelf <i>Unit interior in carcass decor.</i> <i>Not available in visible side colours.</i></p>		H	30	03	RO	72	75	79	82	89	102	118	-	-	-	4	4
		H	45	03	RO	79	83	86	89	95	107	123	-	-	-	4	4
		H	50	03	RO	81	85	89	93	100	113	129	-	-	-	4	4
		H	60	03	RO	84	90	94	98	106	118	134	-	-	-	4	4





Illustrations do not correspond to the door finishes.

3.39

Wall units

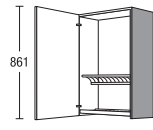
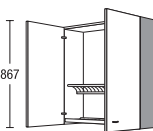
867 mm high

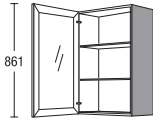
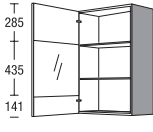
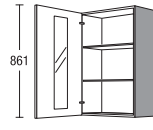
Carcase depth 326 mm



		width	Price group							Servosoft	Pro Servosoft	ProServoGlass	Soft closing Top Motion	Soft closing Top Motion Plus			
			1	2	3	4	5	6	7								
 <p>Wall unit with draining rack 1 hinged door 1 draining rack 1 storage rack 1 removable drip tray <i>Cannot be built-under.</i> <i>Load maximum 15 kg per shelf</i></p>	H	60	03	GT	109	115	119	123	131	140	154	-	-	-	4	4	
 <p>Wall unit with draining rack 2 hinged doors 1 draining rack 1 storage rack 1 removable drip tray <i>Cannot be built-under.</i> <i>Load maximum 15 kg per shelf</i></p>	H	90	03	GT	138	144	151	158	176	193	217	-	-	-	8	8	
 <p>Installation set unit with draining rack Consisting of: 1 draining rack 1 storage rack 1 removable drip tray <i>Load maximum 15 kg per shelf</i></p>	ZIH	60		IX	15	15	15	15	15	15	15	-	-	-	-	-	
	ZIH	90		IX	19	19	19	19	19	19	19	-	-	-	-	-	
 <p>Wall unit with glass door 1 glass door 2 adjustable glass shelves <i>Handles can only be mounted vertically on framed glass doors</i> <i>Handle can only be fitted horizontally on segment glass doors</i></p> <p>Framed glass door No. 701</p> <p><i>Assembly of handles nos. 740, 760, 780, 790 and 800 only horizontal, centred</i></p>  <p>Segmented glass door No. 706</p>  <p>Framed glass door No. 704</p>  <p>Glass door with glazing bars No. 705</p>	HG	45	03		87	91	92	94	103	113	125	-	-	-	4	4	
		HG	50	03		89	93	95	97	107	118	132	-	-	-	4	4
		HG	60	03		92	98	100	102	114	124	137	-	-	-	4	4
		<input type="checkbox"/> HG	45	03	D	104	108	109	111	120	130	143	-	-	-	4	4
		<input type="checkbox"/> HG	50	03	D	106	110	112	114	124	135	149	-	-	-	4	4
		<input type="checkbox"/> HG	60	03	D	109	115	117	119	131	141	154	-	-	-	4	4

3.40 Illustrations do not correspond to the door finishes.

Wall units

867 mm high

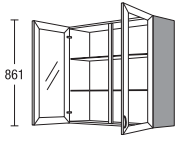
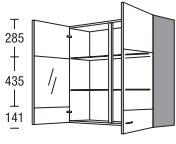
Carcase depth 326 mm

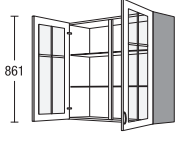
			Price group												
			width	1	2	3	4	5	6	7	Servosoft	Pro Servosoft	ProServoglass	Soft closing Top Motion	Soft closing Top Motion Plus
 <p>Wall unit with glass doors 2 glass doors 2 adjustable glass shelves</p> <p><i>Handles can only be mounted vertically on framed glass doors Handle can only be fitted horizontally on segment glass doors</i></p> <p>Framed glass door No. 701</p>	HG	90		03	114	120	127	134	152	169	192	-	-	-	8
	HG	100	03	117	123	130	137	155	172	195	-	-	-	8	8
 <p><i>Assembly of handles nos. 740, 760, 780, 790 and 800 only horizontal, centred</i></p> <p><i>For glass and frame finishes please refer to programme summary</i></p> <p>Segmented glass door No. 706</p>															
 <p>Framed glass door No. 704</p>															
 <p>Glass door with glazing bars No. 705</p>															

Illustrations do not correspond to the door finishes.

3.41

Wall units, Display wall units

867 mm high

Carcase depth 326 mm

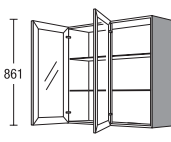
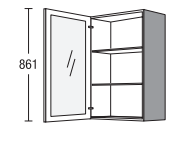
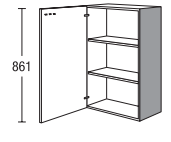
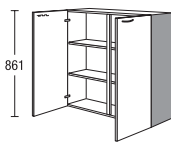

		width	Price group							Servosoft	Pro Servosoft	ProServoGlass	Soft closing Top Motion	Soft closing Top Motion Plus			
			1	2	3	4	5	6	7								
 <p>Wall unit with glass doors 2 glass doors hinged left or right 2 adjustable glass shelves</p> <p><i>Handles can only be mounted vertically on framed glass doors Handle can only be fitted horizontally on segment glass doors</i></p> <p>Framed glass door No. 701</p> <p><i>Assembly of handles nos. 740, 760, 780, 790 and 800 only horizontal, centred</i></p> <p>Segmented glass door No. 706</p> <p>Framed glass door No. 704</p> <p>Glass door with glazing bars No. 705</p>	HG	90	03	TP	117	123	130	137	155	172	195	-	-	-	8	8	
	HG	100	03	TP	120	126	133	140	158	175	198	-	-	-	8	8	
 <p>Wall unit with glass door 1 glass door (range-independent) 2 adjustable glass shelves</p> <p><i>Stainless steel look metal handle profile in the carcass base</i></p> <p>Type -N1</p> <p><i>For glass and frame finishes please refer to programme summary</i></p>	CHG	45	03	N1	132	132	132	132	132	132	132	-	-	-	4	4	
	CHG	50	03	N1	138	138	138	138	138	138	138	-	-	-	4	4	
	CHG	60	03	N1	153	153	153	153	153	153	153	-	-	-	4	4	
	<input type="checkbox"/> D	CHG	45	03	N1D	152	152	152	152	152	152	152	-	-	-	4	4
	<input type="checkbox"/> D	CHG	50	03	N1D	159	159	159	159	159	159	159	-	-	-	4	4
	<input type="checkbox"/> D	CHG	60	03	N1D	174	174	174	174	174	174	174	-	-	-	4	4
 <p>Display wall unit with unit door 1 hinged door 2 adjustable shelves</p>	<input type="checkbox"/> V	VH	30	87	47	50	53	57	64	73	85	-	-	-	4	4	
	<input type="checkbox"/> V	VH	40	87	52	56	59	62	68	77	89	-	-	-	4	4	
	<input type="checkbox"/> V	VH	45	87	54	58	61	64	70	79	91	-	-	-	4	4	
	<input type="checkbox"/> V	VH	50	87	56	60	64	68	75	85	97	-	-	-	4	4	
	<input type="checkbox"/> V	VH	60	87	59	65	69	73	81	90	102	-	-	-	4	4	
 <p>Display wall unit with unit doors 2 hinged doors 2 adjustable shelves</p>	<input type="checkbox"/> V	VH	80	87	78	84	90	97	115	132	153	-	-	-	8	8	
	<input type="checkbox"/> V	VH	90	87	89	95	102	109	127	144	166	-	-	-	8	8	
	<input type="checkbox"/> V	VH	100	87	92	98	105	112	130	147	169	-	-	-	8	8	

3.42 Illustrations do not correspond to the door finishes.

Corner wall units, Diagonal wall units

867 mm high

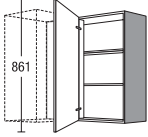
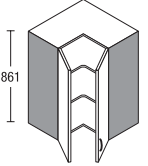
Carcase depth 326 mm

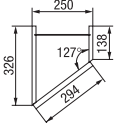
		width	Price group							Servosoft	Pro Servosoft	ProServoglass	Soft closing Top Motion	Soft closing Top Motion Plus
			1	2	3	4	5	6	7					
 <p>Version L</p>	Corner wall unit	HE 80 03	95	100	105	113	117	125	136	-	-	-	4	4
	<p>1 hinged door 2 adjustable shelves</p> <p><i>HE 80 03:</i> Planning dimension 800 x 350 mm to match UE 80, UE 80 KP, UE 80 K in combination with H 45 03</p> <p><i>HE 90 03:</i> Planning dimension 900 x 400 mm to match UE 90, UE 90 KP, UE 90 K in combination with H 50 03</p>	<p>with 45 cm door</p> <p>HE 90 03</p> <p>with 50 cm door</p>	99	103	108	119	124	133	145	-	-	-	4	4
	Corner wall unit	HE 60 03	132	143	150	158	169	184	202	-	-	-	8	8
	<p>2 hinged doors (opening angle approx. 170°) 2 adjustable shelves</p> <p><i>Handle only fitted vertically</i></p> <p><i>Assembly of handles nos. 740, 760, 780, 790 and 800 only horizontal, centred</i></p> <p><i>It is not possible to add a projecting extractor to the left or right side.</i></p> <p><i>HE 60 03:</i> to match corner base units, planning dimensions 900 x 900 mm in conjunction with 2 x H 30 03</p> <p><i>HE 65 03:</i> to match corner base units in planning dimension 1150 x 650 mm in conjunction with 1 x H 50 03</p> <p><i>The hinged doors must open to an angle of at least 100° (observe handle spacing).</i></p> <p><i>Buffer strip colour:</i> Stainless-steel effect: for handle finish in stainless-steel effect Black: for all other handles finishes</p>	HE 65 03	135	149	157	165	177	195	218	-	-	-	8	8
 	Diagonal wall unit	HV 25 03	103	106	109	113	120	129	143	-	-	-	4	4
	<p>326/138 mm deep 1 hinged door 2 adjustable shelves</p>	<p>with 30 cm door</p>												



Illustrations do not correspond to the door finishes.

3.43

Shelf units

867 mm high

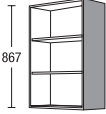
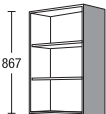
Carcase depth 326 mm

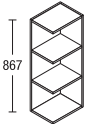
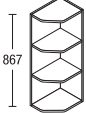
		width	Price group							Servosoft	Pro Servosoft	ProServoGlass	Soft closing Top Motion	Soft closing Top Motion Plus
			1	2	3	4	5	6	7					
 <p>Wall open shelf unit 2 adjustable shelves <i>Finish in carcase material</i> <i>Not available in visible side colours.</i></p>	HR	30	03	61	61	61	61	61	61	61	-	-	-	-
	HR	45	03	64	64	64	64	64	64	64	-	-	-	-
	HR	50	03	65	65	65	65	65	65	65	-	-	-	-
	HR	60	03	67	67	67	67	67	67	67	-	-	-	-
 <p>Wall open shelf unit 2 adjustable shelves <i>Finish in carcase material</i> <i>Please indicate desired width (150-600 mm).</i> <i>Shelves up to 250 mm wide without own suspension fitting</i> <i>Not available in visible side colours.</i></p>	HR	V	03	83	83	83	83	83	83	83	-	-	-	-
 <p>Wall open shelf unit 6 compartments 5 fixed shelves <i>Finish in carcase material</i> <i>Shelf without own mounting fitting</i> <i>Not available in visible side colours.</i></p>	HR	15	03	F	58	58	58	58	58	58	-	-	-	-
 <p>Angled open end shelf 2 fixed shelves <i>Finish in carcase material</i> <i>can be used on both sides</i> <i>Shelf without own mounting fitting</i> <i>Not available in visible side colours.</i></p> <p>Version R</p>	HRA	25	03		55	55	55	55	55	55	-	-	-	-
 <p>Shelf end unit, angled 2 fixed shelves <i>Finish in carcase material</i> <i>can be used on both sides</i> <i>Shelf without own mounting fitting</i> <i>Not available in visible side colours.</i></p> <p>Version R</p>	HRA	25	03	S	45	45	45	45	45	45	-	-	-	-

3.44 Illustrations do not correspond to the door finishes.

Shelf units

867 mm high

Carcase depth 326 mm

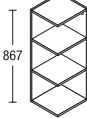
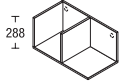
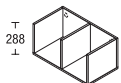
		width		Price group							Servosoft	Pro Servosoft	ProServoGlass	Soft closing Top Motion	Soft closing Top Motion Plus		
				1	2	3	4	5	6	7							
 <p>867</p>	<p>Accent shelf end unit vertical</p> <p>2 fixed shelves</p> <p><i>Finish in carcass material</i></p> <p><i>Available in all carcass finishes.</i></p> <p><i>Additional colour variants:</i> 112 Cappuccino 121 Thyme 133 Volcano brown 134 Alby Blue 158 Sage green 952 Petrol</p> <p><i>Not available in visible side colours.</i></p>	HRA	30	03	80	80	80	80	80	80	80	-	-	-	-	-	
		Version R															
 <p>288</p>	<p>Accent shelf unit horizontal</p> <p>2 fixed dividers</p> <p><i>Finish in carcass material</i></p> <p><i>Available in all carcass finishes.</i></p> <p><i>Additional colour variants:</i> 112 Cappuccino 121 Thyme 133 Volcano brown 134 Alby Blue 158 Sage green 952 Petrol</p> <p><i>Not available in visible side colours.</i></p>	HR	60	29	2	68	68	68	68	68	68	68	-	-	-	-	-
		Version R															
 <p>288</p>	<p>Accent shelf unit horizontal</p> <p>3 fixed dividers</p> <p><i>Finish in carcass material</i></p> <p><i>Available in all carcass finishes.</i></p> <p><i>Additional colour variants:</i> 112 Cappuccino 121 Thyme 133 Volcano brown 134 Alby Blue 158 Sage green 952 Petrol</p> <p><i>Not available in visible side colours.</i></p>	HR	60	29	1	76	76	76	76	76	76	76	-	-	-	-	-
		Version R															



Illustrations do not correspond to the door finishes.

3.45

Shelf units

867 mm high

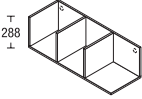
Carcase depth 326 mm

		width	Price group							Servosoft	Pro Servosoft	ProServoGlass	Soft closing Top Motion	Soft closing Top Motion Plus				
			1	2	3	4	5	6	7									
 <p>Version R</p>	Accent shelf unit horizontal 3 fixed dividers <i>Finish in carcase material</i> <i>Available in all carcase finishes.</i> Additional colour variants: 112 Cappuccino 121 Thyme 133 Volcano brown 134 Alby Blue 158 Sage green 952 Petrol <i>Not available in visible side colours.</i>	HR	90	29	2	75	75	75	75	75	75	75	-	-	-	-	-	
	Accent shelf unit horizontal 4 fixed dividers <i>Finish in carcase material</i> <i>Available in all carcase finishes.</i> Additional colour variants: 112 Cappuccino 121 Thyme 133 Volcano brown 134 Alby Blue 158 Sage green 952 Petrol <i>Not available in visible side colours.</i>	HR	90	29	1	83	83	83	83	83	83	83	83	-	-	-	-	-
 <p>867</p>	System shelf unit Set consisting of: 2 metal frames, black 3 shelves in carcase material, 305 mm deep <i>High-gloss finish not available.</i> <i>Installation recommendation - projecting shelves:</i> 50 mm projection up to 450 mm shelf width 75 mm projection from 500 mm shelf width	HR	30	03	TR	100	100	100	100	100	100	100	-	-	-	-	-	
		HR	40	03	TR	103	103	103	103	103	103	103	-	-	-	-	-	
		HR	45	03	TR	105	105	105	105	105	105	105	-	-	-	-	-	
		HR	50	03	TR	108	108	108	108	108	108	108	-	-	-	-	-	
		HR	60	03	TR	111	111	111	111	111	111	111	-	-	-	-	-	
		HR	80	03	TR	114	114	114	114	114	114	114	-	-	-	-	-	
		HR	90	03	TR	117	117	117	117	117	117	117	-	-	-	-	-	
	Individual frames for system shelf unit 1 metal frame, black <i>For individual design.</i> <i>We recommend the use of 3 frames for shelf widths above 900 mm.</i> <i>Installation recommendation - projecting shelves:</i> 50 mm projection up to 450 mm shelf width 75 mm projection from 500 mm shelf width <i>Order shelf RBxx (305 mm deep) separately!</i>	TRH	03			37	37	37	37	37	37	37	37	-	-	-	-	-

3.46 Illustrations do not correspond to the door finishes.

Shelf units

867 mm high

Carcase depth 326 mm

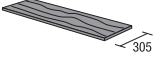
		width	Price group							Servosoft	Pro Servosoft	ProServoGlass	Soft closing Top Motion	Soft closing Top Motion Plus
			1	2	3	4	5	6	7					
 <p>Individual shelves for system shelf unit</p> <p>1 shelf in carcase material, 305 mm deep</p> <p><i>For individual design.</i></p> <p><i>Installation recommendation - projecting shelves:</i></p> <p><i>50 mm projection up to 450 mm shelf width</i> <i>75 mm projection from 500 mm shelf width</i></p> <p><i>Order frame TRHxx separately!</i></p>	RB	30	12	12	12	12	12	12	12	-	-	-	-	-
	RB	40	12	12	12	12	12	12	12	-	-	-	-	-
	RB	45	12	12	12	12	12	12	12	-	-	-	-	-
	RB	50	12	12	12	12	12	12	12	-	-	-	-	-
	RB	60	13	13	13	13	13	13	13	-	-	-	-	-
	RB	80	15	15	15	15	15	15	15	-	-	-	-	-
	RB	90	16	16	16	16	16	16	16	-	-	-	-	-

Illustrations do not correspond to the door finishes.

Filler panels

867 mm high

Carcase depth 326 mm

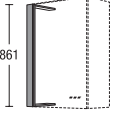
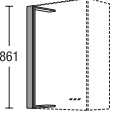
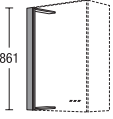
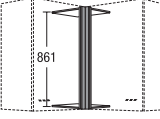
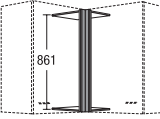
				Price group												
				width	1	2	3	4	5	6	7	Servosoft	Pro Servosoft	ProServoGlass	Soft closing Top Motion	Soft closing Top Motion Plus
 <p>Infill panel for wall units for fitting between wall units</p> <p><i>Finish in door material with straight edge on both sides</i></p> <p><i>Some front edges in colour of carcass.</i></p> <p><i>Not available in visible side colours.</i></p>	HPF	10	03 Z	21	24	25	26	28	30	34	-	-	-	-	-	
	HPF	20	03 Z	34	37	39	41	44	45	48	-	-	-	-	-	
 <p>Infill panel for wall units Fitted between wall and carcass side</p> <p><i>Finish in door material without edging on the wall side</i></p> <p><i>Not available in visible side colours.</i></p> <p><i>Due to the installation angle, the maximum possible on-site width reduction is 46 mm.</i></p>	HPF	10	03	21	24	25	26	28	30	34	-	-	-	-	-	
	HPF	20	03	34	37	39	41	44	45	48	-	-	-	-	-	
 <p>Infill panel for wall units</p> <p><i>Finish in carcass material</i></p> <p><i>Not available in visible side colours.</i></p>	HPK	10	03	14	14	14	14	14	14	14	-	-	-	-	-	
	HPK	20	03	18	18	18	18	18	18	18	-	-	-	-	-	
	HPK	30	03	22	22	22	22	22	22	22	-	-	-	-	-	
 <p>Corner infill panel for wall units for 350 x 350 mm corner with top and base piece</p> <p><i>Finish in carcass material</i></p> <p><i>Not available in visible side colours.</i></p>	HPEK	35	03	26	26	26	26	26	26	26	-	-	-	-	-	
 <p>Corner infill panel for wall units with top and base piece</p> <p><i>Dimensions given are from one carcass corner to another</i></p> <p><i>Finish in door material</i></p> <p><i>Leg dimensions of less than 36 mm width are manufactured from carcass material.</i></p> <p><i>Not available in visible side colours.</i></p>	HPEF	43	03	57	60	62	64	65	66	70	-	-	-	-	-	
	HPEF	53	03	71	74	77	81	84	86	91	-	-	-	-	-	

3.48

Illustrations do not correspond to the door finishes.

Wall units for appliances

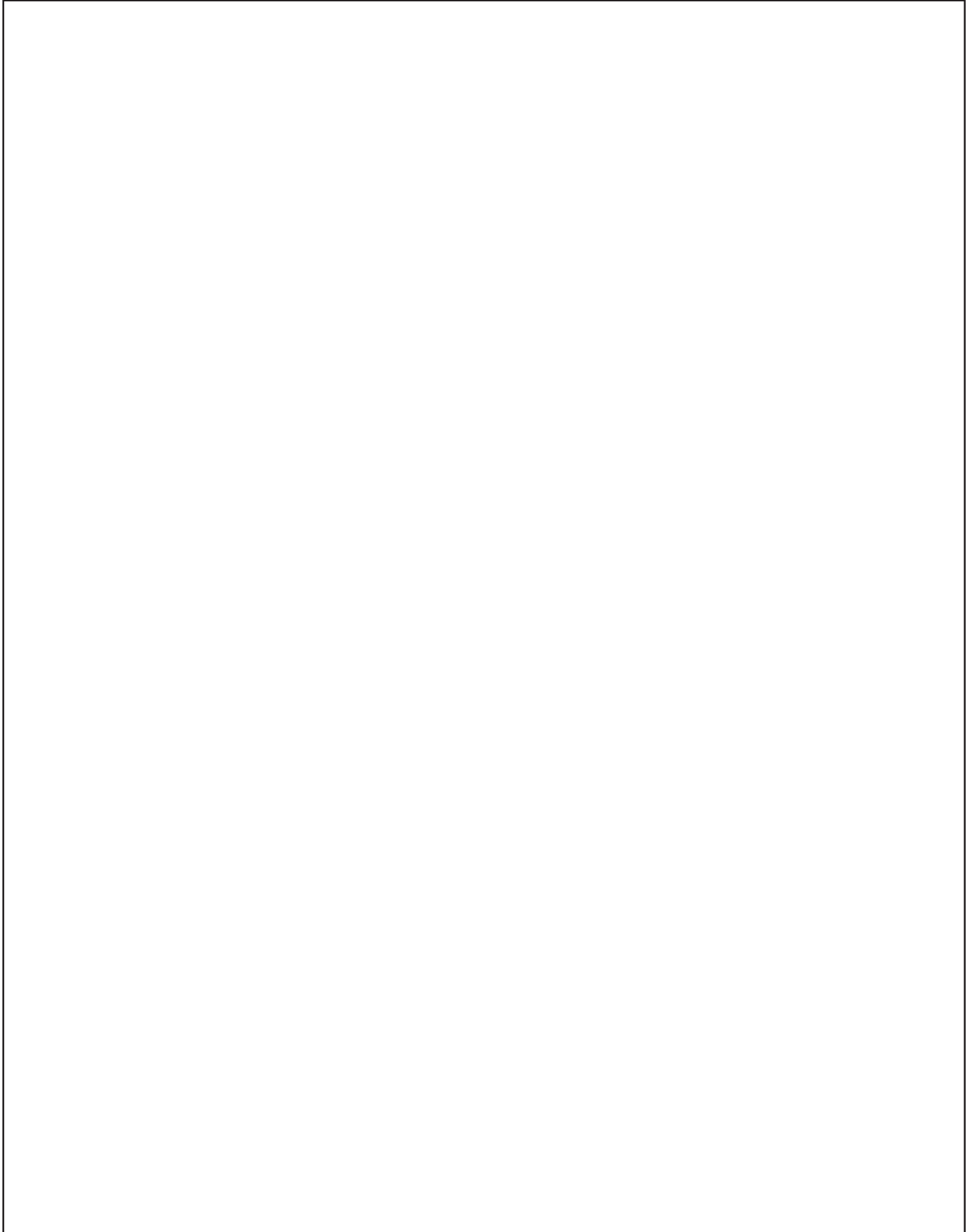

Wall units for appliances





Wall units for appliances



Wall units for appliances

579 mm (01) / 723 mm (02) / 867 mm (03) high

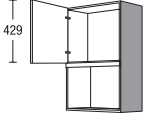
Carcase depth 326 mm



				width		Price group							ServoSoft	Pro ServoSoft	ProServoGlass	Soft closing Top Motion	Soft closing Top Motion Plus
						1	2	3	4	5	6	7					
 <p>HM 6003</p>	<p>Wall unit for microwaves</p> <p>867 mm high Recess height: 350, 364, 380 mm</p> <p>1 hinged door 429 mm high</p> <p><i>Specify appliance type</i></p> <p><i>Niche sizes are adjusted with carcass panel</i></p> <p><i>One front panel per appliance type will be provided for adaptation on site.</i></p>	HM	60	03		80	85	88	90	98	104	111	-	-	-	4	4
	<p>Wall unit for microwaves</p> <p>723 mm high Aperture height: = 364, 380 mm</p> <p>1 flap door 285 mm high</p> <p><i>Specify appliance type</i></p> <p><i>Niche sizes are adjusted with carcass panel</i></p> <p><i>One front panel per appliance type will be provided for adaptation on site.</i></p> <p><i>Handle only fitted horizontally</i></p> <p><i>Not possible in combination with Top Motion Plus</i></p>	HM	60	02		79	84	86	88	95	100	107	-	-	-	4	14
	<p>Wall unit for microwaves</p> <p>579 mm high Recess height: 350, 364, 380 mm</p> <p>1 fixed front panel 173 mm high</p> <p><i>Specify appliance type</i></p> <p><i>Niche sizes are adjusted with carcass panel</i></p>	HM	60	01		57	61	62	64	71	75	82	-	-	-	-	-
	<p>Wall unit for microwaves</p> <p>723 mm high Niche height 341 mm Aperture depth: 306 mm</p> <p>1 flap door</p> <p><i>Unit interior in carcass decor.</i></p> <p><i>Not available in visible side colours.</i></p> <p><i>Handle only fitted horizontally</i></p> <p><i>For free-standing appliances</i></p>	<input type="checkbox"/> HM	60	02	RU	76	81	85	89	96	107	121	-	-	-	7	17

Illustrations do not correspond to the door finishes.

Wall units for appliances

579 mm (01) / 723 mm (02) / 867 mm (03) high

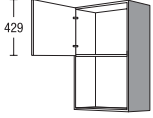
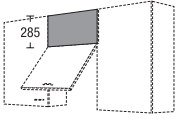
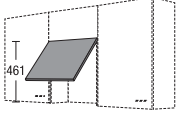
Carcase depth 326 mm



		width	Price group							Servosoft	Pro Servosoft	ProServoGlass	Soft closing Top Motion	Soft closing Top Motion Plus
			1	2	3	4	5	6	7					
 <p>Wall unit for microwaves D</p> <p>HM</p> <p>60 03 RU</p> <p>867 mm high Niche height 413 mm Aperture depth: 306 mm</p> <p>1 hinged door</p> <p><i>Unit interior in carcass decor.</i></p> <p><i>Not available in visible side colours.</i></p> <p><i>For free-standing appliances</i></p>			79	85	88	92	100	111	125	-	-	-	4	4
 <p>Panel for above recirculation cooker hood panel</p> <p>HFB</p> <p>60 14</p> <p>for installation between wall units</p> <p><i>Finish in door material</i></p> <p><i>When planning at the end of a line plan KBMM as visible panel</i></p> <p><i>Owing to air outlet do not fit a closed ceiling infill.</i></p>			10	13	15	17	23	27	32	-	-	-	-	-
			17	20	22	24	30	34	39	-	-	-	-	-
			16	19	21	23	29	33	38	-	-	-	-	-
 <p>Front panel for 600 mm wide integrated extractor</p> <p>TD</p> <p>60 46</p> <p>461 mm high</p> <p><i>Handle only fitted horizontally</i></p> <p><i>For circulating air mode, use front panel HK 60 29 instead of top unit HFB 60 29.</i></p> <p>TD 60 46</p>			19	22	24	26	33	39	46	-	-	-	-	-
			23	26	28	31	39	46	55	-	-	-	-	-
 <p>Front panel with 2 sides and back panel for cooker hoods</p> <p>HD</p> <p>60 46</p> <p>467 mm high with upper shelf</p> <p><i>Handle only fitted horizontally</i></p> <p><i>Depending on appliance, an adjustment must be made on site.</i></p> <p><i>When used as a circulation hood no dresser unit HK 60 29 must be planned.</i></p> <p><i>Use front panel HFB 60 29.</i></p>			62	65	66	68	75	81	89	-	-	-	4	14

3.50 Illustrations do not correspond to the door finishes.

Wall units for appliances

579 mm (01) / 723 mm (02) / 867 mm (03) high

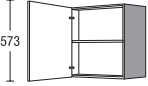
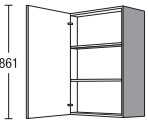
Carcase depth 326 mm

		width		Price group							ServoSoft	Pro ServoSoft	ProServoGlass	Soft closing Top Motion	Soft closing Top Motion Plus		
				1	2	3	4	5	6	7							
<p>Information positioning frame for flat extractors</p> <p>Our wall units for telescopic extractors are not compatible with positioning frames for built-in appliances.</p>																	
 <p>HD 60 01</p>	<p>Wall unit for telescopic cooker hood</p> <p>579 mm high 1 hinged door 1 adjustable shelf</p> <p><i>Specify appliance type</i></p> <p><i>Depending on appliance, an adjustment must be made on site.</i></p>	HD	60	01	87	93	96	100	102	110	120	-	-	-	4	4	
	<p>Wall unit for telescopic cooker hood</p> <p>same as above, but 723 mm high</p>	HD	60	02	96	103	107	112	116	125	137	-	-	-	4	4	
	 <p>HD 60 03</p>	<p>Wall unit for telescopic cooker hood</p> <p>867 mm high 1 hinged door 2 adjustable shelves</p> <p><i>Specify appliance type</i></p> <p><i>Depending on appliance, an adjustment must be made on site.</i></p> <p><i>Rear panel set forward for appliance.</i></p>	HD	60	03	101	109	114	119	125	136	149	-	-	-	4	4
	<p>Wall unit for telescopic cooker hood</p> <p>435 mm high 1 hinged door 1 adjustable shelf</p> <p><i>Specify appliance type</i></p> <p><i>Not available in visible side colours.</i></p> <p><i>Rear panel set forward for appliance.</i></p> <p><i>Depending on appliance, an adjustment must be made on site.</i></p>	HD	60	43	73	78	81	85	97	104	111	-	-	-	4	14	
	<p>Wall unit for telescopic cooker hood</p> <p>435 mm high 1 flap door</p> <p><i>Specify appliance type</i></p> <p><i>Depending on appliance, an adjustment must be made on site.</i></p> <p><i>Not available in visible side colours.</i></p>	HD	60	43	K	80	86	89	93	95	103	113	-	-	-	7	17

Illustrations do not correspond to the door finishes.

3.51

Wall units for appliances

579 mm (01) / 723 mm (02) / 867 mm (03) high

Carcase depth 326 mm

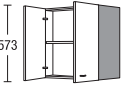

		width	Price group							Servosoft	Pro Servosoft	ProServoGlass	Soft closing Top Motion	Soft closing Top Motion Plus			
			1	2	3	4	5	6	7								
	Wall unit for telescopic cooker hood 579 mm high 2 hinged doors 1 adjustable shelf (depending on finish) <i>Specify appliance type</i> <i>Rear panel set forward for appliance.</i> <i>Depending on appliance, an adjustment must be made on site.</i>	HD	60	01	2	90	96	99	103	106	114	124	-	-	-	8	8
	Wall unit for telescopic cooker hood 723 mm high 2 hinged doors 1-2 adjustable shelves (according to version) <i>Specify appliance type</i> <i>Rear panel set forward for appliance.</i> <i>Depending on appliance, an adjustment must be made on site.</i>	HD	60	02	2	99	106	110	116	120	129	141	-	-	-	8	8
	Wall unit for telescopic cooker hood 867 mm high 2 hinged doors 1-2 adjustable shelves (according to version) <i>Specify appliance type</i> <i>Rear panel set forward for appliance.</i> <i>Depending on appliance, an adjustment must be made on site.</i>	HD	60	03	2	104	112	117	123	129	140	153	-	-	-	8	8
	Wall unit for telescopic cooker hood For appliances with a 900 mm wide housing/ motor and a screen width of 900 mm 579 mm high 2 hinged doors 1 adjustable shelf (depending on finish) <i>Specify appliance type</i> <i>Rear panel set forward for appliance.</i> <i>Depending on appliance, an adjustment must be made on site.</i>	HD	90	01		104	111	115	120	122	131	143	-	-	-	8	8

3.52 Illustrations do not correspond to the door finishes.

Wall units for appliances

579 mm (01) / 723 mm (02) / 867 mm (03) high

Carcase depth 326 mm

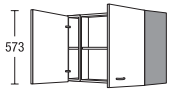
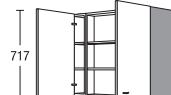
		width		Price group													
		90	02	1	2	3	4	5	6	7	Servosoft	Pro Servosoft	ProServoglass	Soft closing Top Motion	Soft closing Top Motion Plus		
 <p>Wall unit for telescopic cooker hood For appliances with a 900 mm wide housing/ motor and a screen width of 900 mm 723 mm high 2 hinged doors 1-2 adjustable shelves (according to version) Specify appliance type Rear panel set forward for appliance. Depending on appliance, an adjustment must be made on site.</p>	HD	90	02	117	126	130	137	141	152	167	-	-	-	8	8		
	 <p>Wall unit for telescopic cooker hood For appliances with a 900 mm wide housing/ motor and a screen width of 900 mm 867 mm high 2 hinged doors 1-2 adjustable shelves (according to version) Specify appliance type Rear panel set forward for appliance. Depending on appliance, an adjustment must be made on site.</p>	HD	90	03	124	134	140	146	153	167	184	-	-	-	8	8	
		 <p>Wall unit for telescopic cooker hood For appliances with a 600 mm wide housing/ motor and a screen width of 900 mm 579 mm high 2 hinged doors 2 shelf units in wall unit depth to left and right of extractor enclosure 1-2 adjustable shelves (according to version) Specify appliance type Rear panel set forward for appliance. Depending on appliance, an adjustment must be made on site. Shelf units in same colour as carcass</p>	HD	90	01	RS	211	217	221	226	237	249	270	-	-	-	8
	 <p>Wall unit for telescopic cooker hood For appliances with a 600 mm wide housing/ motor and a screen width of 900 mm 723 mm high 2 hinged doors 2 shelf units in wall unit depth to left and right of extractor enclosure 1-2 adjustable shelves (according to version) Specify appliance type Rear panel set forward for appliance. Depending on appliance, an adjustment must be made on site. Shelf units in same colour as carcass</p>		HD	90	02	RS	227	233	239	245	259	274	298	-	-	-	8

Illustrations do not correspond to the door finishes.

Wall units for appliances

579 mm (01) / 723 mm (02) / 867 mm (03) high

Carcase depth 326 mm

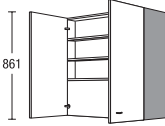
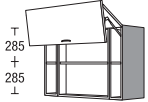
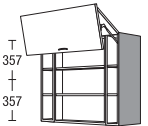
		width	Price group							Servosoft	Pro Servosoft	ProServoGlass	Soft closing Top Motion	Soft closing Top Motion Plus				
			1	2	3	4	5	6	7									
 <p>Wall unit for telescopic cooker hood</p> <p>For appliances with a 600 mm wide housing/ motor and a screen width of 900 mm 867 mm high 2 hinged doors 2 shelf units in wall unit depth to left and right of extractor enclosure 1-2 adjustable shelves (according to version)</p> <p><i>Specify appliance type</i></p> <p><i>Rear panel set forward for appliance.</i></p> <p><i>Depending on appliance, an adjustment must be made on site.</i></p> <p><i>Shelf units in same colour as carcass</i></p>	HD	90	03	RS	243	249	256	263	281	298	326	-	-	-	8	8		
	 <p>Wall unit for telescopic cooker hood</p> <p>For appliances with a 600 mm wide housing/ motor and a screen width of 900 mm 579 mm high 1 folding lift-up door consisting of 2 fronts 2 shelf units in wall unit depth to left and right of extractor enclosure 1-2 adjustable shelves (according to version)</p> <p><i>Specify appliance type</i></p> <p><i>Rear panel set forward for appliance.</i></p> <p><i>Depending on appliance, an adjustment must be made on site.</i></p> <p><i>Shelf units in same colour as carcass</i></p>	HDFK	90	01	RS	289	298	302	307	318	330	354	-	-	-	-	-	
		 <p>Wall unit for telescopic cooker hood</p> <p>For appliances with a 600 mm wide housing/ motor and a screen width of 900 mm 723 mm high 1 folding lift-up door consisting of 2 fronts 2 shelf units in wall unit depth to left and right of extractor enclosure 1-2 adjustable shelves (according to version)</p> <p><i>Specify appliance type</i></p> <p><i>Rear panel set forward for appliance.</i></p> <p><i>Depending on appliance, an adjustment must be made on site.</i></p> <p><i>Shelf units in same colour as carcass</i></p>	HDFK	90	02	RS	325	336	341	346	359	375	404	-	-	-	-	-

3.54 Illustrations do not correspond to the door finishes.

Wall units for appliances

539 mm (01) / 683 mm (02) / 827 mm (03) high

Carcase depth 326 mm

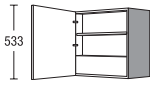
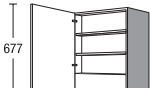
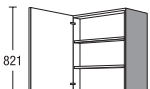

				width	Price group							Servosoft	Pro Servosoft	ProServoglass	Soft closing Top Motion	Soft closing Top Motion Plus		
					1	2	3	4	5	6	7							
 <p>Wall unit for telescopic cooker hood</p> <p>539 mm high 1 hinged door 1 adjustable shelf</p> <p><i>Specify appliance type</i></p> <p><i>Depending on appliance, an adjustment must be made on site.</i></p> <p><i>Rear panel set forward for appliance.</i></p> <p><i>Available for the following ranges: IP 1200, IP 2200, IP 3150, IP 4050</i></p> <p><i>Cannot be combined with handles 680, 700, 740, 760, 780, 790, 800, 810 and 820.</i></p>	HD	60	01	E40	214	219	222	225	-	-	-	-	-	-	4	4		
	 <p>Wall unit for telescopic cooker hood</p> <p>683 mm high 1 hinged door 2 adjustable shelves</p> <p><i>Specify appliance type</i></p> <p><i>Depending on appliance, an adjustment must be made on site.</i></p> <p><i>Rear panel set forward for appliance.</i></p> <p><i>Available for the following ranges: IP 1200, IP 2200, IP 3150, IP 4050</i></p> <p><i>Cannot be combined with handles 680, 700, 740, 760, 780, 790, 800, 810 and 820.</i></p>	HD	60	02	E40	224	230	234	238	-	-	-	-	-	-	4	4	
		 <p>Wall unit for telescopic cooker hood</p> <p>827 mm high 1 hinged door 2 adjustable shelves</p> <p><i>Specify appliance type</i></p> <p><i>Depending on appliance, an adjustment must be made on site.</i></p> <p><i>Rear panel set forward for appliance.</i></p> <p><i>Available for the following ranges: IP 1200, IP 2200, IP 3150, IP 4050</i></p> <p><i>Cannot be combined with handles 680, 700, 740, 760, 780, 790, 800, 810 and 820.</i></p>	HD	60	03	E40	232	239	243	247	-	-	-	-	-	-	4	4

Illustrations do not correspond to the door finishes.

Wall units for appliances

539 mm (01) / 683 mm (02) / 827 mm (03) high

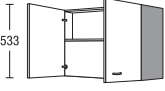
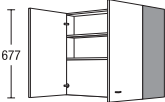
Carcase depth 326 mm

		width	Price group							Servosoft	Pro Servosoft	ProServoGlass	Soft closing Top Motion	Soft closing Top Motion Plus		
			1	2	3	4	5	6	7							
 <p>Wall unit for telescopic cooker hood For appliances with a 900 mm wide housing/motor and a screen width of 900 mm 539 mm high 2 hinged doors</p> <p><i>Specify appliance type</i></p> <p><i>Rear panel set forward for appliance.</i></p> <p><i>Depending on appliance, an adjustment must be made on site.</i></p> <p><i>Available for the following ranges: IP 1200, IP 2200, IP 3150, IP 4050</i></p> <p><i>Cannot be combined with handles 680, 700, 740, 760, 780, 790, 800, 810 and 820.</i></p>	HD	90	01	E40	297	304	308	312	-	-	-	-	-	8	8	
	 <p>Wall unit for telescopic cooker hood same as above, but 683 mm high 1 adjustable shelf</p>	HD	90	02	E40	309	317	323	328	-	-	-	-	-	8	8
		 <p>Wall unit for telescopic cooker hood same as above, but 827 mm high 2 adjustable shelves</p>	HD	90	03	E40	325	335	340	346	-	-	-	-	-	8

3.56

Illustrations do not correspond to the door finishes.

Back panels for canopy hoods

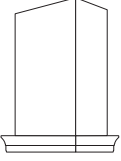
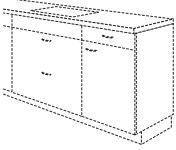
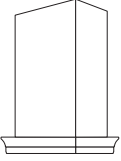
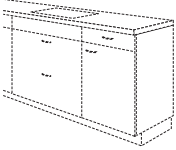
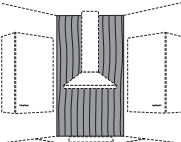
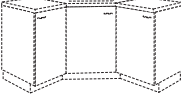
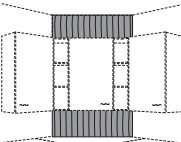
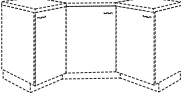
				Price group												
				width	1	2	3	4	5	6	7	Servosoft	Pro Servosoft	ProServoglass	Soft closing Top Motion	Soft closing Top Motion Plus
 <p>Chimney hood with cornice 900 mm wide, 500 mm deep For room heights up to 2600 mm Intended for independent suspension Funnel in carcass material</p> <p><i>Not available in visible side colours. Cutouts for appliance to be made on site. Maximum cutout dimensions (W x D): 668 x 395 mm</i></p> <p><i>Colour finish: IP 4250, white No. 786 IP 4250, magnolia white No. 787 IP 4250, graphite No. 956 IP 4250, space grey no. 957</i></p> 	HD	90	LH	366	366	366	366	366	366	366	-	-	-	-	-	
 <p>Chimney hood with cornice 900 mm wide, 500 mm deep For room heights up to 2600 mm Intended for independent suspension Funnel of raw chipboard, lacquered</p> <p><i>Not available in visible side colours. Cutouts for appliance to be made on site. Maximum cutout dimensions (W x D): 668 x 395 mm</i></p> <p><i>Available in all Colour Concept colours</i></p> 	HD	90	LHCK	541	541	541	541	541	541	541	-	-	-	-	-	
 <p>Corner back panel for cooker hood 960 mm wide, 1800 mm high, for max. 2600 mm room height with 105 mm plinth (blind corner 680x680 mm) 16 mm thick</p> <p><i>Finish in carcass material Not available in visible side colours.</i></p> 	RWED	90		50	50	50	50	50	50	50	-	-	-	-	-	
 <p>Corner back panel 1110 mm wide, 1800 mm high, for max. 2600 mm room height with 105 mm plinth (blind corner 786x786 mm) 16 mm thick</p> <p><i>Finish in carcass material Not available in visible side colours.</i></p> 	RWED	110		65	65	65	65	65	65	65	-	-	-	-	-	

Illustrations do not correspond to the door finishes.

Notes

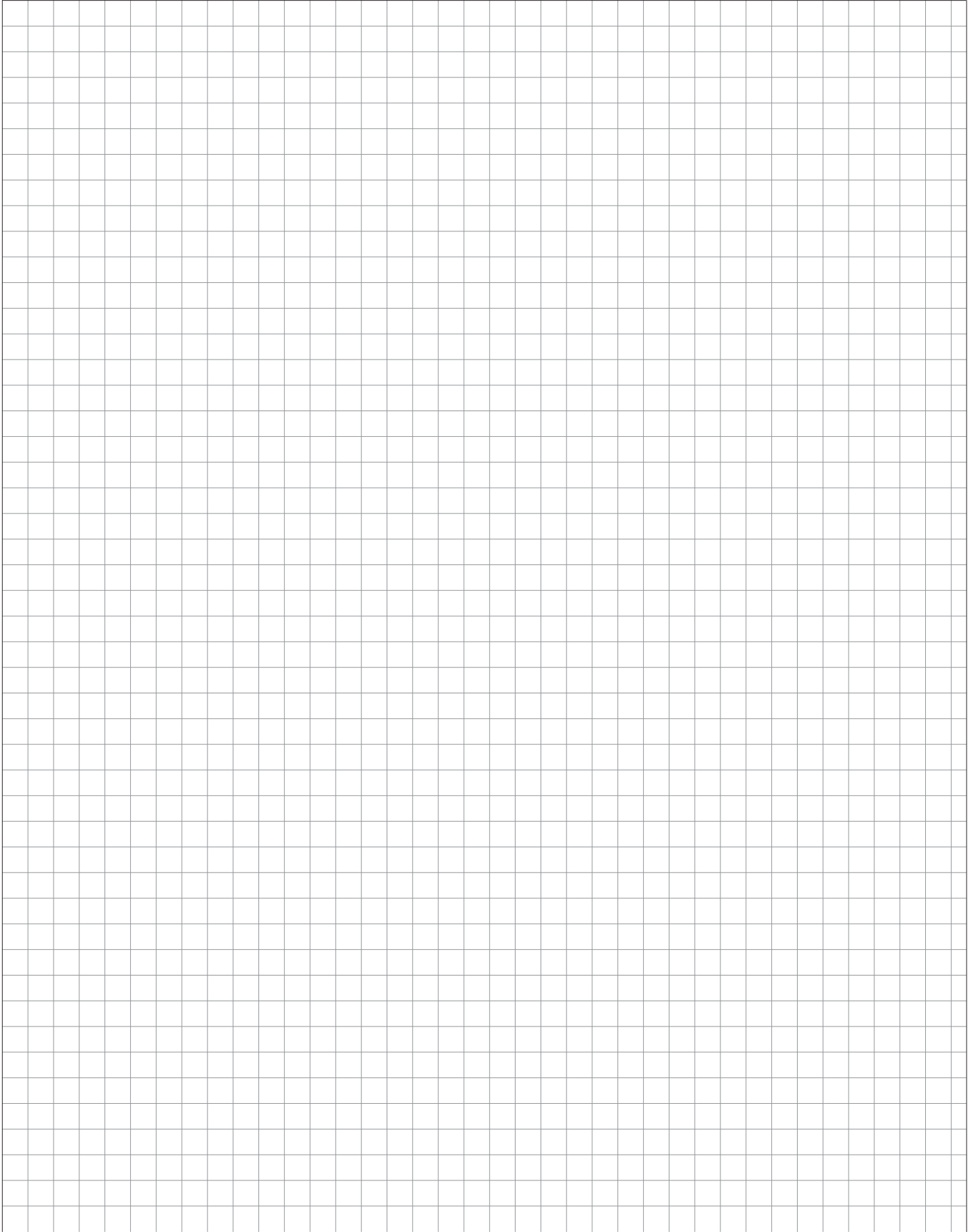

Dresser units

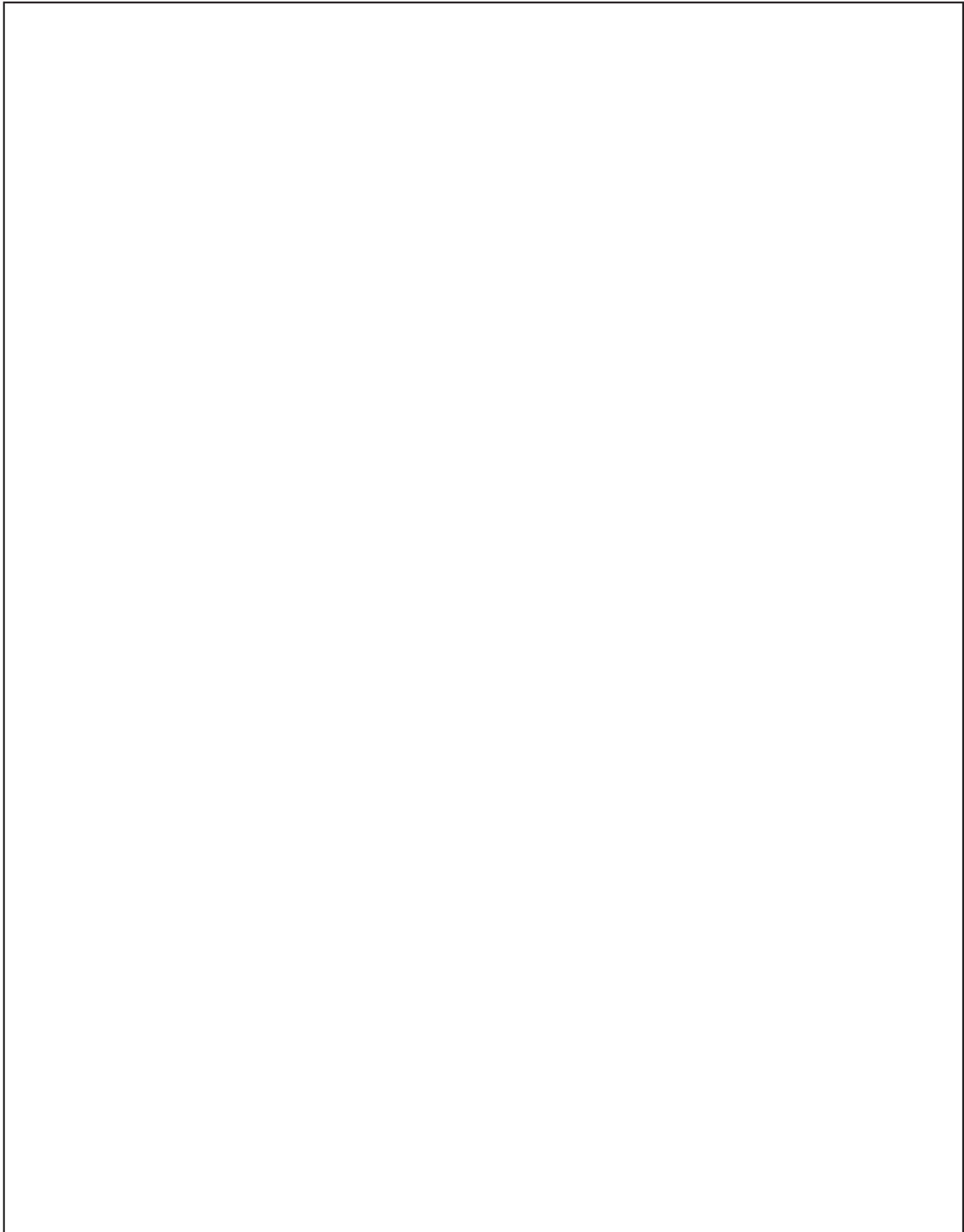

Dresser units



Dresser units



Dresser units

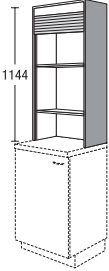
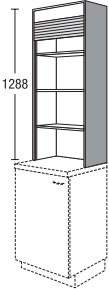
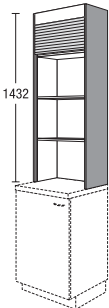

Carcase depth 326 mm

						width		Price group													
								1	2	3	4	5	6	7	Servosoft	Pro Servosoft	ProServoglass	Soft closing Top Motion	Soft closing Top Motion Plus		
 <p>1144</p>	<p>Dresser unit with roller shutter 1144 mm high (01 height)</p> <p>to be placed on a 40 mm thick worktop</p> <p>Laminate roller shutter, coated, with matching strip handle 1 adjustable shelf 1 fixed shelf</p> <p><i>Available colours for roller shutter doors:</i> <i>roller shutter stainless steel No. 522 (encased)</i> <i>Black no. 523</i> <i>Slat height 25 mm</i></p> <p><i>Unit interior in carcass decor.</i></p> <p><i>Not available in visible side colours.</i></p>	D	ARO	60	01	33		304	304	304	304	304	304	304	-	-	-	-	-		
	 <p>1288</p>	<p>Dresser unit with roller shutter 1288 mm high (02 height)</p> <p>to be placed on a 40 mm thick worktop</p> <p>Laminate roller shutter, coated, with matching strip handle 2 adjustable shelves 1 fixed shelf</p> <p><i>Available colours for roller shutter doors:</i> <i>roller shutter stainless steel No. 522 (encased)</i> <i>Black no. 523</i> <i>Slat height 25 mm</i></p> <p><i>Unit interior in carcass decor.</i></p> <p><i>Not available in visible side colours.</i></p>	D	ARO	60	02	33		315	315	315	315	315	315	315	-	-	-	-	-	
		 <p>1432</p>	<p>Dresser unit with roller shutter 1432 mm high (03 height)</p> <p>to be placed on a 40 mm thick worktop</p> <p>Laminate roller shutter, coated, with matching strip handle 2 adjustable shelves 1 fixed shelf</p> <p><i>Available colours for roller shutter doors:</i> <i>roller shutter stainless steel No. 522 (encased)</i> <i>Black no. 523</i> <i>Slat height 25 mm</i></p> <p><i>Unit interior in carcass decor.</i></p> <p><i>Not available in visible side colours.</i></p>	D	ARO	60	03	33		325	325	325	325	325	325	325	-	-	-	-	-

Illustrations do not correspond to the door finishes.

Dresser units

carcase depth 560 mm

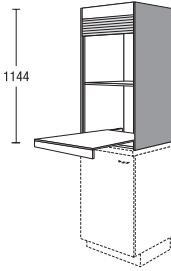
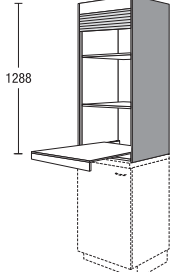
		width		Price group											
				1	2	3	4	5	6	7	Servosoft	Pro Servosoft	ProServoGlass	Soft closing Top Motion	Soft closing Top Motion Plus
 <p>Top box for tall units 291 mm high</p> <p>1 flap door</p> <p>Handle only fitted horizontally</p> <p>For use in conjunction with wall units in 03 height and tall units in 01 height</p> <p>Rear panel set forward for ventilation of appliances</p> <p>Only as combination with tall units in height 01 and wall units in height 03.</p> <p>Do not plan any tall units in height 03 beside the combination of tall unit height 01 and top unit.</p>	AK	30	29	39	43	45	47	52	55	60	-	-	-	7	17
	AK	45	29	47	50	52	55	61	64	68	-	-	-	7	17
	AK	50	29	49	53	56	59	63	66	71	-	-	-	7	17
	AK	60	29	51	54	57	60	66	70	76	-	-	-	7	17
	AK	90	29	66	70	74	77	86	90	99	-	-	-	7	17
 <p>Top box for tall units 363 mm high</p> <p>1 flap door</p> <p>Handle only fitted horizontally</p>	AK	60	36	65	69	73	77	84	90	97	-	-	-	7	17
	AK	90	36	80	85	90	94	104	110	120	-	-	-	7	17
	AK	100	36	86	92	97	102	113	120	131	-	-	-	9	19
 <p>Top-mounted unit with roller shutter door and pull-out shelf D 1144 mm high (height 01)</p> <p>to be placed on a 40 mm thick worktop</p> <p>Laminate roller shutter, coated, with matching strip handle</p> <p>1 adjustable shelf</p> <p>1 pull-out shelf Load-bearing capacity 40 kg</p> <p>Available colours for roller shutter doors: roller shutter stainless steel No. 522 (encased) Black no. 523 Slat height 25 mm</p> <p>Unit interior in carcase decor.</p> <p>Not available in visible side colours.</p>	ARO	60	01	TA	449	449	449	449	449	449	-	-	-	-	-
 <p>Top-mounted unit with roller shutter door and pull-out shelf D 1288 mm high (height 02)</p> <p>to be placed on a 40 mm thick worktop</p> <p>Laminate roller shutter, coated, with matching strip handle</p> <p>2 adjustable shelves</p> <p>1 pull-out shelf Load-bearing capacity 40 kg</p> <p>Available colours for roller shutter doors: roller shutter stainless steel No. 522 (encased) Black no. 523 Slat height 25 mm</p> <p>Unit interior in carcase decor.</p> <p>Not available in visible side colours.</p>	ARO	60	02	TA	476	476	476	476	476	476	-	-	-	-	-

Dresser units

carcase depth 560 mm

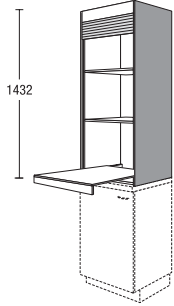

Top-mounted unit with roller shutter door and pull-out shelf



ARO 60 03 TA

1432 mm high (height 03)

to be placed on a 40 mm thick worktop

- Laminate roller shutter, coated, with matching strip handle
- 2 adjustable shelves
- 1 pull-out shelf Load-bearing capacity 40 kg

Available colours for roller shutter doors:
roller shutter stainless steel No. 522 (encased)
Black no. 523
Slat height 25 mm

Unit interior in carcase decor.

Not available in visible side colours.

width

Price group

1 2 3 4 5 6 7

Servosoft
 Pro Servosoft
 ProServoglass
 Soft closing Top Motion
 Soft closing Top Motion Plus

503 503 503 503 503 503 503

- - - - -

Illustrations do not correspond to the door finishes.

Dresser units

carcase depth 560 mm

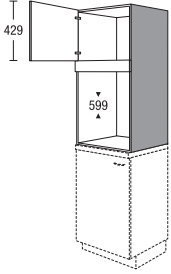
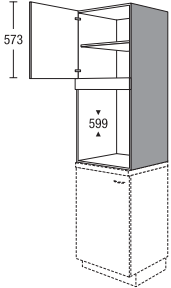
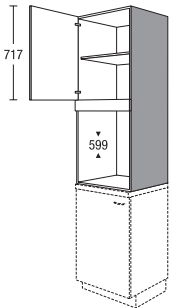
	width	Price group							Servosoft	Pro Servosoft	ProServoGlass	Soft closing Top Motion	Soft closing Top Motion Plus	
		1	2	3	4	5	6	7						
 <p>Dresser unit 1144 mm high (01 height) to be placed on a 40 mm thick worktop</p> <p>niche sizes: 599 mm high, max. 568 mm wide, 560 mm deep</p> <p>1 hinged door 1 fixed front panel</p> <p><i>Oven model must be indicated</i></p> <p><i>For foil-wrapped fronts a set of heat deflector plates are supplied free of charge.</i></p>	AB	01	157	169	180	191	215	239	269	-	-	-	4	4
 <p>Dresser unit 1288 mm high (02 height) to be placed on a 40 mm thick worktop</p> <p>niche sizes: 599 mm high, max. 568 mm wide, 560 mm deep</p> <p>1 hinged door 1 adjustable shelf 1 fixed front panel</p> <p><i>Oven model must be indicated</i></p> <p><i>For foil-wrapped fronts a set of heat deflector plates are supplied free of charge.</i></p>	AB	02	169	183	194	206	232	258	290	-	-	-	4	4
 <p>Dresser unit 1432 mm high (03 height) to be placed on a 40 mm thick worktop</p> <p>niche sizes: 599 mm high, max. 568 mm wide, 560 mm deep</p> <p>1 hinged door 1 adjustable shelf 1 fixed front panel</p> <p><i>Oven model must be indicated</i></p> <p><i>For foil-wrapped fronts a set of heat deflector plates are supplied free of charge.</i></p>	AB	03	177	191	202	215	242	269	302	-	-	-	4	4

3.62

Illustrations do not correspond to the door finishes.

Dresser units

carcase depth 560 mm

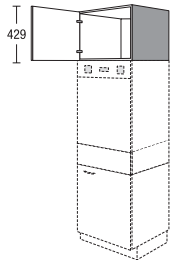
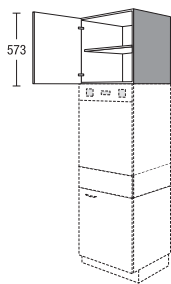
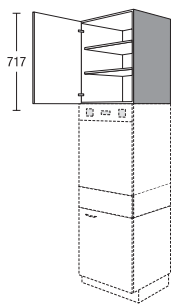
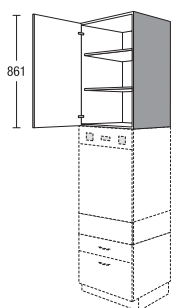
		width		Price group							Servosoft	Pro Servosoft	ProServoglass	Soft closing Top Motion	Soft closing Top Motion Plus	
				1	2	3	4	5	6	7						
	<p>Dresser unit</p> <p>to be placed on electrical appliances in combination with plinth platform and fixed panel for plinth platform</p> <p>1 hinged door</p> <p><i>Bottom shelf white.</i></p> <p><i>Can only be installed between modular panels or units.</i></p>	A	60	43	60	64	68	72	81	90	101	-	-	-	4	4
	<p>Dresser unit</p> <p>to be placed on electrical appliances in combination with plinth platform and fixed panel for plinth platform</p> <p>1 hinged door</p> <p>1 adjustable shelf</p> <p><i>Bottom shelf white.</i></p> <p><i>Can only be installed between modular panels or units.</i></p>	A	60	58	65	70	74	78	88	97	110	-	-	-	4	4
	<p>Dresser unit</p> <p>to be placed on electrical appliances in combination with plinth platform and fixed panel for plinth platform</p> <p>1 hinged door</p> <p>2 adjustable shelves</p> <p><i>Bottom shelf white.</i></p> <p><i>Can only be installed between modular panels or units.</i></p>	A	60	72	70	76	80	85	95	105	118	-	-	-	4	4
	<p>Dresser unit</p> <p>to be placed on electrical appliances in combination with plinth platform and fixed panel for plinth platform</p> <p>1 hinged door</p> <p>2 adjustable shelves</p> <p><i>Bottom shelf white.</i></p> <p><i>Can only be installed between modular panels or units.</i></p>	A	60	87	85	91	97	103	115	128	143	-	-	-	4	4

Illustrations do not correspond to the door finishes.

Dresser units

carcase depth 560 mm

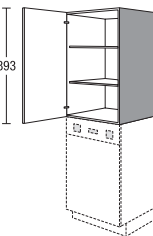
		width	Price group							Servosoft	Pro Servosoft	ProServoGlass	Soft closing Top Motion	Soft closing Top Motion Plus		
			1	2	3	4	5	6	7							
	<p>Dresser unit 899 mm (1619 highboard height) as top unit on electrical appliances</p> <p>1 hinged door 2 adjustable shelves</p> <p><i>Bottom shelf white.</i></p> <p><i>Can only be installed between modular panels or units.</i></p>	A	60	90	96	103	110	116	130	145	162	-	-	-	4	4
	<p>Dresser unit as top unit on electrical appliances</p> <p>1 hinged door 2 adjustable shelves</p> <p><i>Bottom shelf white.</i></p> <p><i>Can only be installed between modular panels or units.</i></p>	A	60	104	119	128	136	144	163	181	212	-	-	-	4	4
	<p>Dresser unit 1187 mm high (height 01) as top unit on electrical appliances</p> <p>1 hinged door 3 adjustable shelves</p> <p><i>Bottom shelf white.</i></p> <p><i>Can only be installed between modular panels or units.</i></p>	A	60	118	131	141	150	159	179	199	233	-	-	-	6	6
	<p>Dresser unit 1331 mm high (height 02) as top unit on electrical appliances</p> <p>1 hinged door 3 adjustable shelves</p> <p><i>Bottom shelf white.</i></p> <p><i>Can only be installed between modular panels or units.</i></p>	A	60	133	136	146	156	165	186	207	242	-	-	-	6	6

3.64

Illustrations do not correspond to the door finishes.

Dresser units

carcase depth 560 mm

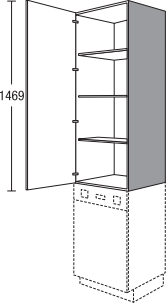
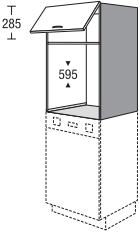
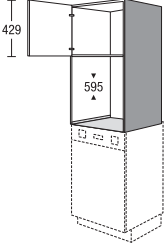
				Price group														
		width		1	2	3	4	5	6	7	Servosoft	Pro Servosoft	ProServoglass	Soft closing Top Motion	Soft closing Top Motion Plus			
	<p>Dresser unit 1475 mm high (height 03) as top unit on electrical appliances</p> <p>1 hinged door 3 adjustable shelves</p> <p><i>Bottom shelf white.</i></p> <p><i>Can only be installed between modular panels or units.</i></p>	NEW	A	60	148	144	155	165	175	197	219	256	-	-	-	8	8	
		<p>Top-mounted unit for oven 899 mm (1619 highboard height) as top unit on electrical appliances</p> <p>niche sizes: 595 mm high, max. 568 mm wide, 560 mm deep</p> <p>1 flap door 1 metal shelf</p> <p><i>Specify appliance type</i></p> <p><i>For foil-wrapped fronts a set of heat deflector plates are supplied free of charge.</i></p> <p><i>Can only be installed between modular panels or units.</i></p>		AB	90	K	139	149	160	168	188	209	235	-	-	-	7	17
			<p>Top-mounted unit for oven 1043 mm high as top unit on electrical appliances</p> <p>niche sizes: 595 mm high, max. 568 mm wide, 560 mm deep</p> <p>1 hinged door 1 metal shelf</p> <p><i>Specify appliance type</i></p> <p><i>For foil-wrapped fronts a set of heat deflector plates are supplied free of charge.</i></p> <p><i>Can only be installed between modular panels or units.</i></p>		AB	104		155	167	177	188	213	236	276	-	-	-	4

Illustrations do not correspond to the door finishes.

Dresser units

carcase depth 560 mm

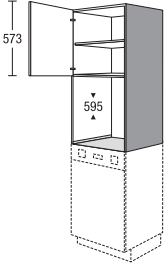
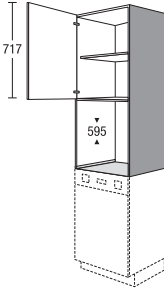
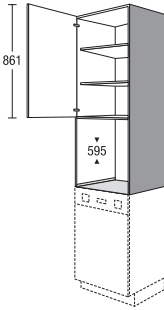
		width	Price group							Servosoft	Pro Servosoft	ProServoGlass	Soft closing Top Motion	Soft closing Top Motion Plus	
			1	2	3	4	5	6	7						
 <p>Top-mounted unit for oven 1187 mm high (height 01) as top unit on electrical appliances</p> <p>niche sizes: 595 mm high, max. 568 mm wide, 560 mm deep</p> <p>1 hinged door 1 shelf 1 metal shelf</p> <p><i>Specify appliance type</i></p> <p><i>For foil-wrapped fronts a set of heat deflector plates are supplied free of charge.</i></p> <p><i>Can only be installed between modular panels or units.</i></p>	☑	AB	118	163	176	187	197	223	247	290	-	-	-	4	4
 <p>Top-mounted unit for oven 1331 mm high (height 02) as top unit on electrical appliances</p> <p>niche sizes: 595 mm high, max. 568 mm wide, 560 mm deep</p> <p>1 hinged door 1 shelf 1 metal shelf</p> <p><i>Specify appliance type</i></p> <p><i>For foil-wrapped fronts a set of heat deflector plates are supplied free of charge.</i></p> <p><i>Can only be installed between modular panels or units.</i></p>	☑	AB	133	171	185	195	208	234	260	292	-	-	-	4	4
 <p>Top-mounted unit for oven 1475 mm high (height 03) as top unit on electrical appliances</p> <p>niche sizes: 595 mm high, max. 568 mm wide, 560 mm deep</p> <p>1 hinged door 2 shelves 1 metal shelf</p> <p><i>Specify appliance type</i></p> <p><i>For foil-wrapped fronts a set of heat deflector plates are supplied free of charge.</i></p> <p><i>Can only be installed between modular panels or units.</i></p>	☑	AB	148	173	187	197	210	237	263	295	-	-	-	4	4

Dresser units

carcase depth 560 mm

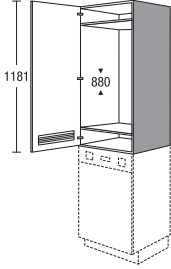
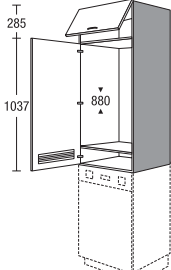
		width	Price group							Servosoft	Pro Servosoft	ProServoglass	Soft closing Top Motion	Soft closing Top Motion Plus	
			1	2	3	4	5	6	7						
	<p>Dresser unit for built-in appliance <input checked="" type="checkbox"/></p> <p>1187 mm high (height 01)</p> <p>as top unit on electrical appliances</p> <p>niche height 880 mm</p> <p>1 appliance door 1 ventilation grille</p> <p><i>Specify appliance type</i></p> <p><i>Ventilation grille for on-site installation.</i></p> <p><i>Can only be installed between modular panels or units.</i></p> <p><i>Handle only fitted vertically</i></p> <p><i>Cannot be combined with handles 740, 760, 780, 790 and 800.</i></p> <p><i>Available for the following ranges:</i> IP 1200, IP 2200, IP 3150, IP 4050, IP 6800 CK</p>	A88	118	141	152	161	171	193	214	251	-	-	-	6	6
		<p>Dresser unit for built-in appliance <input checked="" type="checkbox"/></p> <p>1331 mm high (height 02)</p> <p>as top unit on electrical appliances</p> <p>niche height 880 mm</p> <p>1 flap door 1 appliance door 1 ventilation grille</p> <p><i>Specify appliance type</i></p> <p><i>Ventilation grille for on-site installation.</i></p> <p><i>Can only be installed between modular panels or units.</i></p> <p><i>Handle only fitted vertically</i></p> <p><i>Cannot be combined with handles 740, 760, 780, 790 and 800.</i></p> <p><i>Available for the following ranges:</i> IP 1200, IP 2200, IP 3150, IP 4050, IP 6800 CK</p>	A88	133 K	149	160	170	180	203	225	263	-	-	-	10

Illustrations do not correspond to the door finishes.

Dresser units

carcase depth 560 mm

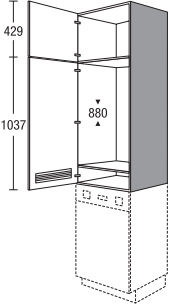
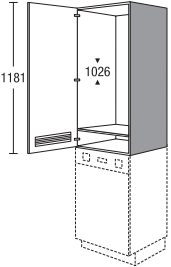
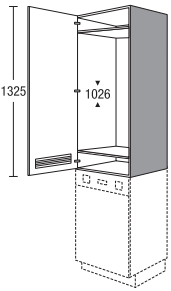
		width	Price group							Servosoft	Pro Servosoft	ProServoGlass	Soft closing Top Motion	Soft closing Top Motion Plus	
			1	2	3	4	5	6	7						
 <p>Dresser unit for built-in appliance 1475 mm high (height 03)</p> <p>as top unit on electrical appliances</p> <p>niche height 880 mm</p> <p>1 hinged door 1 appliance door 1 ventilation grille</p> <p><i>Specify appliance type</i></p> <p><i>Ventilation grille for on-site installation.</i></p> <p><i>Handle only fitted vertically</i></p> <p><i>Cannot be combined with handles 740, 760, 780, 790 and 800.</i></p> <p><i>Available for the following ranges: IP 1200, IP 2200, IP 3150, IP 4050, IP 6800 CK</i></p>	☑	A88	148	150	161	172	182	205	228	267	-	-	-	10	10
 <p>Dresser unit for built-in appliance 1187 mm high (height 01)</p> <p>as top unit on electrical appliances</p> <p>Recess height 1026 mm</p> <p>1 appliance door 1 ventilation grille</p> <p><i>Specify appliance type</i></p> <p><i>Ventilation grille for on-site installation.</i></p> <p><i>Can only be installed between modular panels or units.</i></p> <p><i>Handle only fitted vertically</i></p> <p><i>Cannot be combined with handles 740, 760, 780, 790 and 800.</i></p> <p><i>Available for the following ranges: IP 1200, IP 2200, IP 3150, IP 4050, IP 6800 CK</i></p>	☑	A102	118	136	146	156	165	186	207	242	-	-	-	6	6
 <p>Dresser unit for built-in appliance 1331 mm high (height 02)</p> <p>as top unit on electrical appliances</p> <p>Recess height 1026 mm</p> <p>1 appliance door 1 ventilation grille</p> <p><i>Specify appliance type</i></p> <p><i>Ventilation grille for on-site installation.</i></p> <p><i>Can only be installed between modular panels or units.</i></p> <p><i>Handle only fitted vertically</i></p> <p><i>Cannot be combined with handles 740, 760, 780, 790 and 800.</i></p> <p><i>Available for the following ranges: IP 1200, IP 2200, IP 3150, IP 4050, IP 6800 CK</i></p>	☑	A102	133	138	148	158	167	189	210	246	-	-	-	6	6

3.68

Illustrations do not correspond to the door finishes.

Dresser units

carcase depth 560 mm

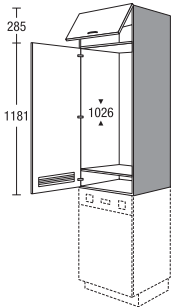
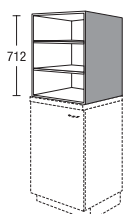
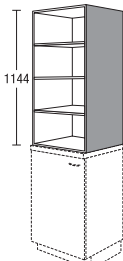
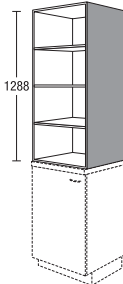
				Price group													
		width		1	2	3	4	5	6	7	Servosoft	Pro Servosoft	ProServoglass	Soft closing Top Motion	Soft closing Top Motion Plus		
 <p>Dresser unit for built-in appliance 1475 mm high (height 03) as top unit on electrical appliances Recess height 1026 mm 1 flap door 1 appliance door 1 ventilation grille <i>Specify appliance type</i> <i>Ventilation grille for on-site installation.</i> <i>Can only be installed between modular panels or units.</i> <i>Handle only fitted vertically</i> <i>Cannot be combined with handles 740, 760, 780, 790 and 800.</i> <i>Available for the following ranges: IP 1200, IP 2200, IP 3150, IP 4050, IP 6800 CK</i></p>	✓	A102	148	K	157	169	179	190	213	237	277	-	-	-	10	20	
	 <p>Dresser shelf unit 712 mm high (1475 highboard height) to be placed on a 40 mm thick worktop 2 adjustable shelves <i>Finish in carcase material</i> <i>Not available in visible side colours.</i></p>	D	AR	60	148	148	148	148	148	148	148	148	-	-	-	-	-
		D	AR	65	148	166	166	166	166	166	166	166	166	-	-	-	-
	 <p>Dresser shelf unit 1144 mm high (height 01) to be placed on a 40 mm thick worktop 3 adjustable shelves <i>Finish in carcase material</i> <i>Not available in visible side colours.</i></p>	D	AR	60	01	172	172	172	172	172	172	172	-	-	-	-	-
D		AR	65	01	192	192	192	192	192	192	192	192	-	-	-	-	-
 <p>Dresser shelf unit 1288 mm high (height 02) to be placed on a 40 mm thick worktop 3 adjustable shelves <i>Finish in carcase material</i> <i>Not available in visible side colours.</i></p>	D	AR	60	02	180	180	180	180	180	180	180	-	-	-	-	-	
	D	AR	65	02	199	199	199	199	199	199	199	199	-	-	-	-	-

Illustrations do not correspond to the door finishes.

3.69

Dresser units

carcase depth 560 mm

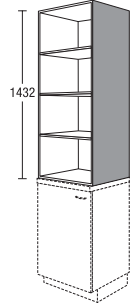

Dresser shelf unit
1432 mm high (height 03)
 to be placed on a 40 mm thick worktop
 3 adjustable shelves
Finish in carcase material
Not available in visible side colours.

D AR
 D AR

width

Price group

1	2	3	4	5	6	7
187	187	187	187	187	187	187
207	207	207	207	207	207	207

Servosoft
 Pro Servosoft
 ProServoGlass
 Soft closing Top Motion
 Soft closing Top Motion Plus

Filler panels

Carcase depth 326 mm

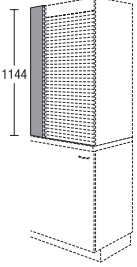
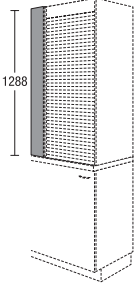
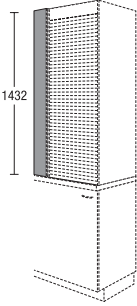
				Price group											
		width		1	2	3	4	5	6	7	Servosoft	Pro Servosoft	ProServoglass	Soft closing Top Motion	Soft closing Top Motion Plus
 <p>Infill panel for top-mounted units 1144 mm high (height 01) <i>Finish in carcass material Not available in visible side colours.</i></p>	APK	10	01	17	17	17	17	17	17	17	-	-	-	-	-
	APK	20	01	23	23	23	23	23	23	23	-	-	-	-	-
	APK	30	01	29	29	29	29	29	29	29	-	-	-	-	-
 <p>Infill panel for top-mounted units 1288 mm high (height 02) <i>Finish in carcass material Not available in visible side colours.</i></p>	APK	10	02	17	17	17	17	17	17	17	-	-	-	-	-
	APK	20	02	23	23	23	23	23	23	23	-	-	-	-	-
	APK	30	02	29	29	29	29	29	29	29	-	-	-	-	-
 <p>Infill panel for top-mounted units 1432 mm high (height 03) <i>Finish in carcass material Not available in visible side colours.</i></p>	APK	10	03	18	18	18	18	18	18	18	-	-	-	-	-
	APK	20	03	24	24	24	24	24	24	24	-	-	-	-	-
	APK	30	03	30	30	30	30	30	30	30	-	-	-	-	-

Illustrations do not correspond to the door finishes.

Notes

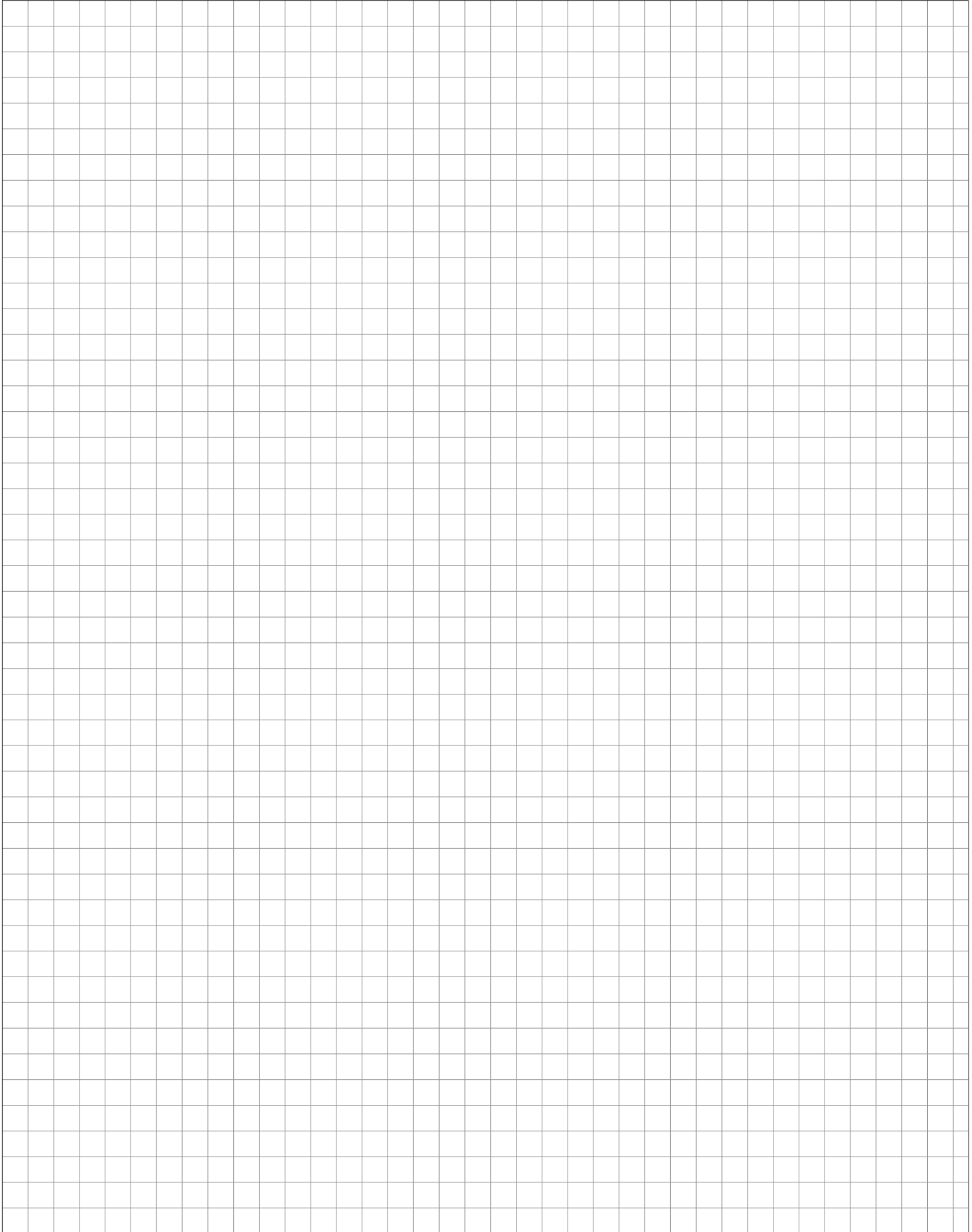

4. Tall units, highboards

Legend of symbols used

Summary of the most commonly planned highboards

Summary of the most used/planned tall units

Information on types produced

Highboards 1043 mm

Highboards 1475 mm

Tall units 1619 mm

Tall units 1907 mm, height 01

Tall units 2051 mm, height 02

Tall units 2195 mm, height 03

Modules for raised dishwashers

4. Tall units, highboards



Legend of symbols used



Width reduction

For surcharges and information see register 9 Design elements, special topics, sub-register Surcharges/miscellaneous

Units shortened to the next smallest unit width available.
Example: unit width 600 mm = shortened to 501 mm

Reduction only available for reducible ranges with edging finish.
Possible ranges:
IP 1200, IP 2200, IP 3150, IP 4050

Width reduction of D-handles and knobs is possible.

Handle designs depending on length (bar handles, grip ledges) are not possible where width is shortened.



Depth reduction

For surcharges and information see register 9 Design elements, special topics, sub-register Surcharges/miscellaneous



Width and depth reduction

Combination of both variants

For surcharges and information see register 9 Design elements, special topics, sub-register Surcharges/miscellaneous

Information on customised products

Please note the possible customisations for cabinets.

The following individualisations are possible:

- Width reduction
- Depth reduction
- Carcase with increased side depth

You will find further information on this under register 9 Design elements, special topics, sub-register Surcharges/miscellaneous.

Equipment versions

	<p>Drawers / deep drawers in standard finish TANDEMBOX plus</p> <p>Colour silver grey Version: 506 = full-extension pull-out with Servosoft (allow for surcharge!)</p>
	<p>Drawers / deep drawers Professional (surcharge) TANDEMBOX antaro</p> <p>Colour anthracite Full-extension pull-out with Servosoft Version: 508 = Professional full-extension pull-out with Servosoft</p>
	<p>Drawers / deep drawers Professional with glass side (surcharge) TANDEMBOX antaro</p> <p>Colour anthracite Full-extension pull-out with Servosoft Versions: 510 = Professional with Servosoft and clear glass 512 = Professional with Servosoft and frosted glass</p>
	<p>Non-slip mats (surcharge per unit)</p> <p>All drawers / deep drawers in a batch are fitted with the available non-slip mats</p> <p>Drawer / deep drawer features: Versions: 99 = Without non-slip mat 106 = Non-slip mat in silver-grey 108 = Non-slip mat in anthracite</p>
	<p>Clip hinge, standard version</p> <p>Version 414</p> <p>in combination with a high-quality flap stay</p>
	<p>Cushioning for hinged doors Top Motion (surcharge)</p> <p>Version 418</p> <p>Integrated door cushioning CLIP top BLUMOTION by Blum in combination with a high-quality flap stay</p>
	<p>Cushioning for hinged doors Top Motion (surcharge)</p> <p>Version 428</p> <p>Integrated door cushioning CLIP top BLUMOTION by Blum in combination with AVENTOS HKS flap stay by Blum</p>

Summary of the most commonly planned highboards

1475 mm high

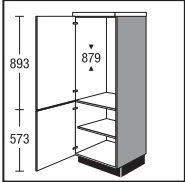
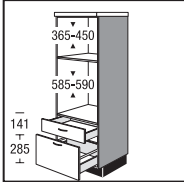
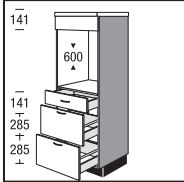
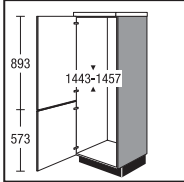
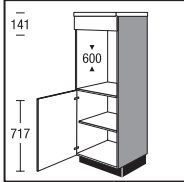
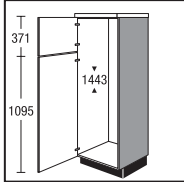
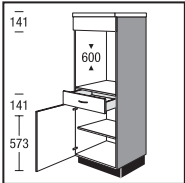
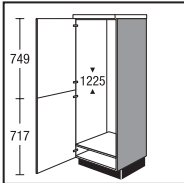
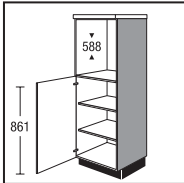
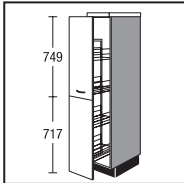
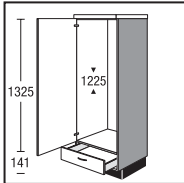
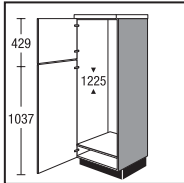
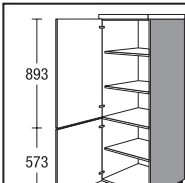
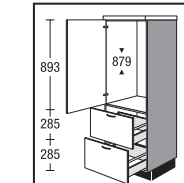
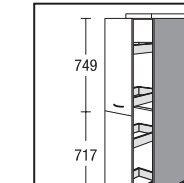
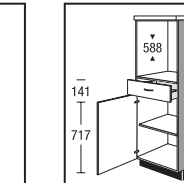
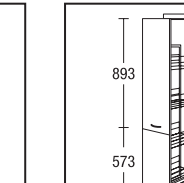
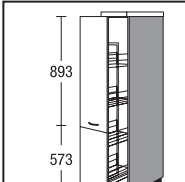
					
G88148X	GMBSA148	GBS2A148B	G145148X	GB148B	G1451486
					
GBS148B	G122148	GB1482	SA30148	G122S148	G1221485
					
S30148X S60148X	G882A148X	SA30148S	GBS148	SA30148X	
					
SA30148PX					

Summary of the most used/planned tall units

1907 mm high Height 01

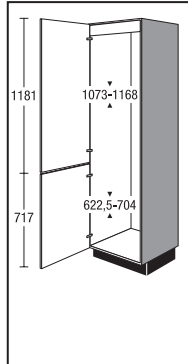

G17801

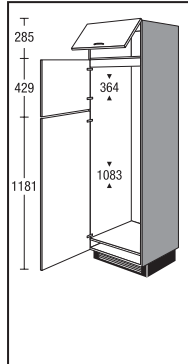

G14501K8

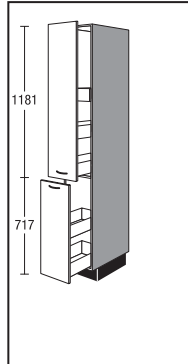

SA3001S

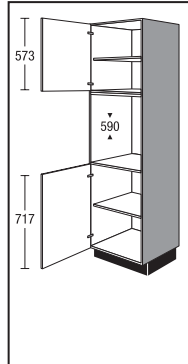

GB01

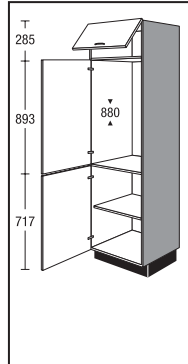

G8801K

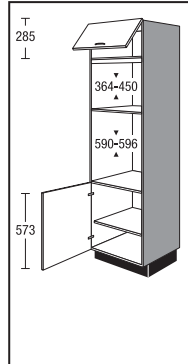

GMB01KX

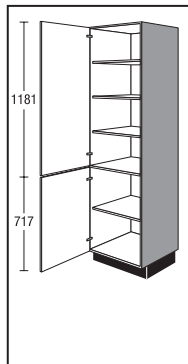

S3001
S4501
S5001
S6001

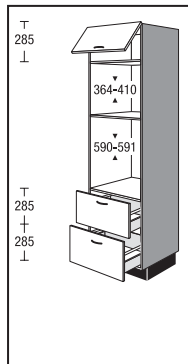

GMB2A01KX

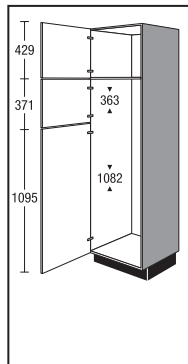

G145016

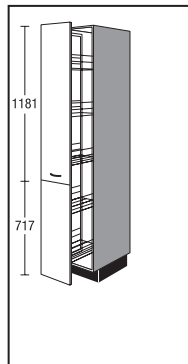

SA3001

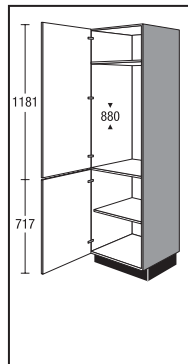

G8801

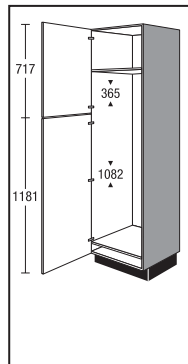

G145018

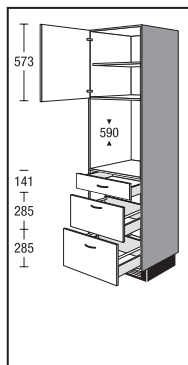

GBS2A01

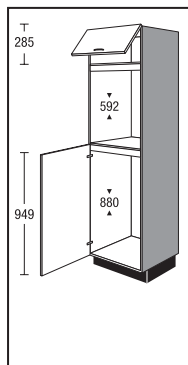

G88B01K4

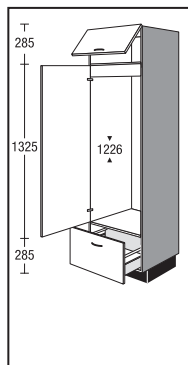

G122A01K

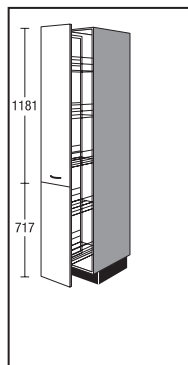

SA3001P

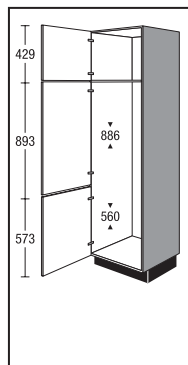

G14501X

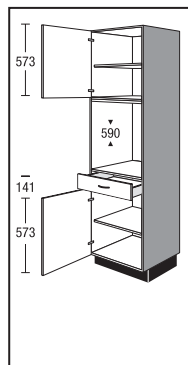

GBS01

Summary of the most used/planned tall units

2051 mm high Height 02

G17802	S3002 S6002	GMB2A02X	GB02	GMB02X	GBS2A02
G88B024	SA3002	G122A02	SA3002P	G8802	GMB2A02Y
S6002B	S30022 S45022 S50022 S60022	G145026	SA3002S	G102M025	

Summary of the most used/planned tall units

2195 mm high Height 03

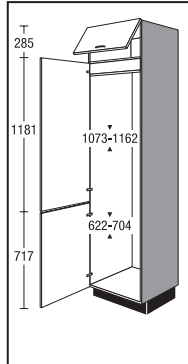

G17803K

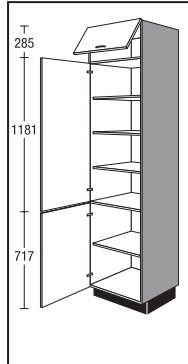

S3003K
S4503K
S5003K
S6003K

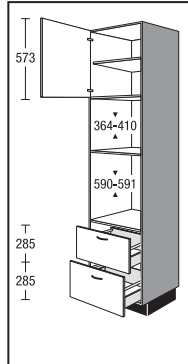

GMB2A03X

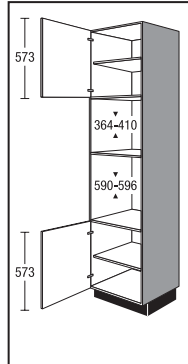

GMB03X

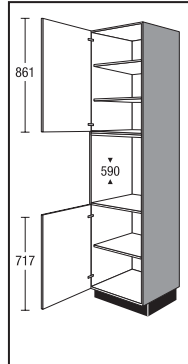

GB03

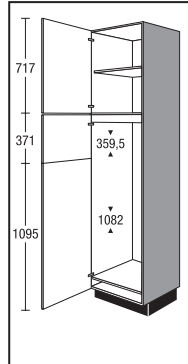

G145036

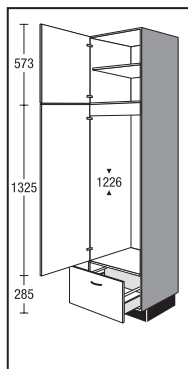

G122A03

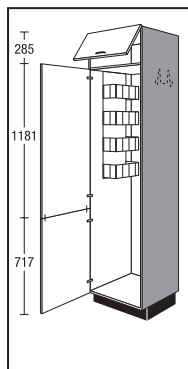

S4503KB
S5003KB
S6003KB

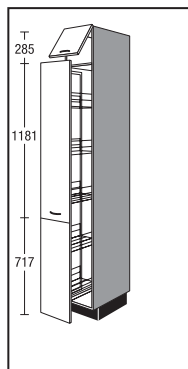

SA3003K

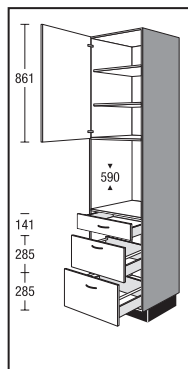

GBS2A03

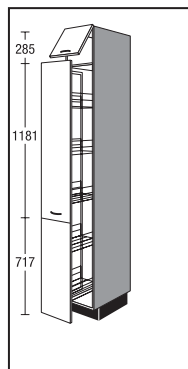

SA3003KP

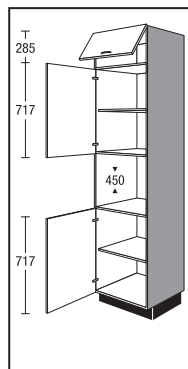

GM03K

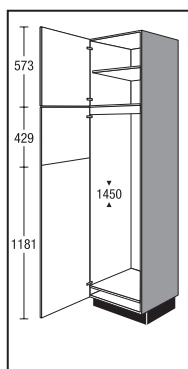

G145038

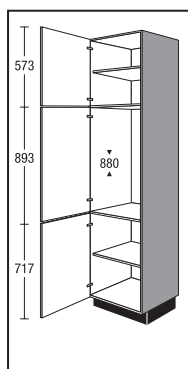

G8803

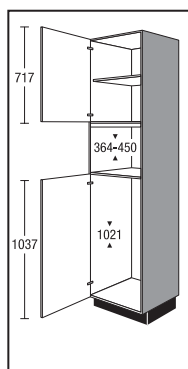

G102M035

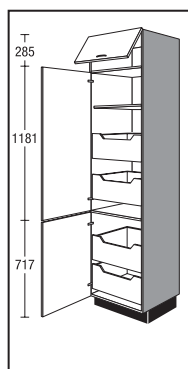

S3003KIA
S4503KIA
S5003KIA
S6003KIA

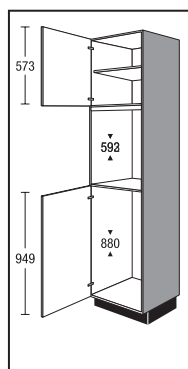

G88B034

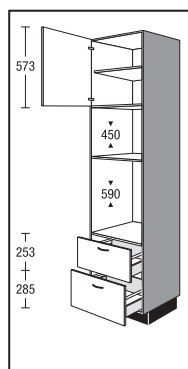

GMB2A03Y

Information on types produced

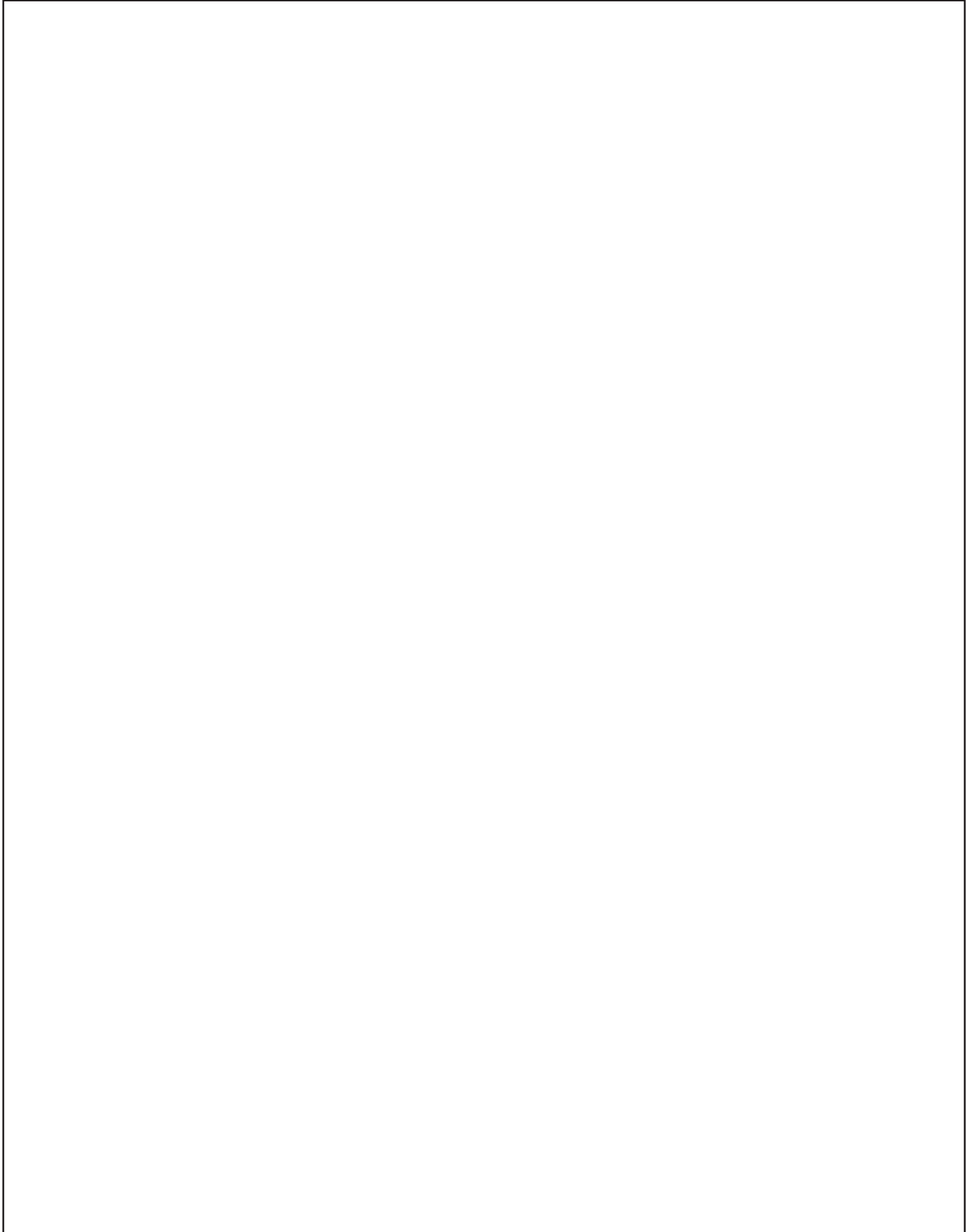





Information on tall units for integrated appliances

An overview of all possible sales types can be found on the following pages, in addition to the corresponding production types.

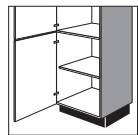
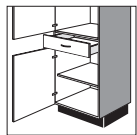
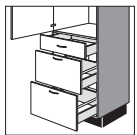
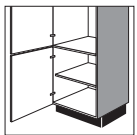
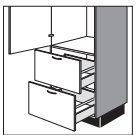
The unit division is marked with simple symbols and is supplemented with the corresponding height.

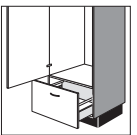
Options	Example					
<ul style="list-style-type: none"> ⊙ Flap door ⊖ Fixed front panel ⊙ Door ‡ Dowelled fronts Ⓢ Appliance niche (additionally highlighted in grey) Ⓟ Lift-up door for microwave (A lift-up door for this niche can be retrofitted on site. Please order separately, item LKP 60 43) ⊖ Drawer Ⓜ Deep drawer 	<div style="display: flex; align-items: center;"> <div style="border: 1px solid black; padding: 5px; margin-right: 10px;"> ⊙ 429 ⊙ 893 Ⓢ 880 ⊖ 141 ⊖ 285 ⊖ 285 </div> <div> <p>Unit layout from top to bottom:</p> <ul style="list-style-type: none"> 1 hinged door 429 mm high 1 hinged door 893 mm high 1 integrated niche 880 mm 1 drawer 141 mm high 1 deep drawer 285 mm high 1 deep drawer 285 mm high </div> </div> <p style="text-align: center; margin-top: 10px;">G88S2A 03 SIA</p>					
<p>Available "base unit versions"</p>						
						
<p>G88 1 hinged door 1 shelf</p>	<p>G88S 1 drawer 1 hinged door</p>	<p>G88S2A 1 drawer 2 deep drawers</p>	<p>G88...X 1 hinged door 1 shelf</p>	<p>G882A 2 deep drawers</p>	<p>G882SA...X 2 drawers 1 deep drawer</p>	<p>G88A 1 deep drawer</p>
<p>When ordering, it is essential to state the appliance code as stated in the manufacturer's price list and the code number of the required unit.</p>						

Information on highboards for integrated appliances

Sales / Production types 1475 mm

⊕ 88

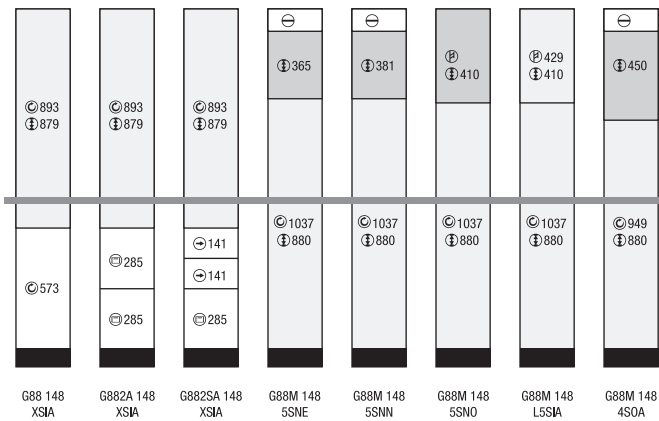

⊕ 102

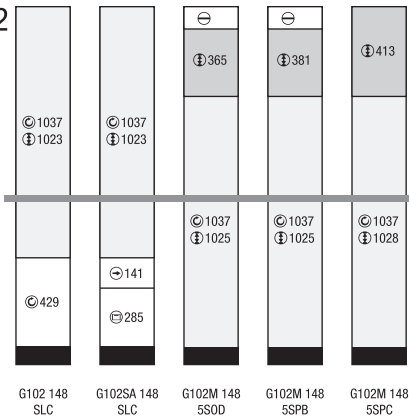

⊕ 122

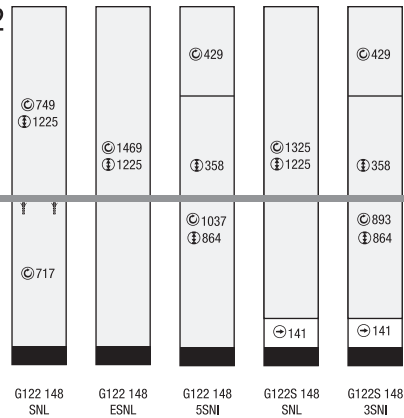

⊕ 140



⊕ 145

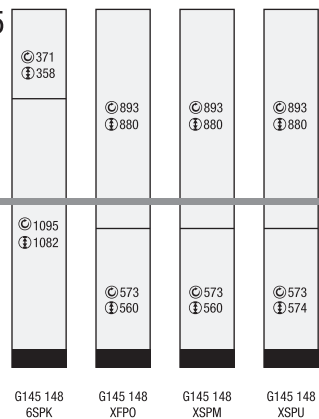

Information on highboards for integrated appliances

Sales / Production types 1475 mm

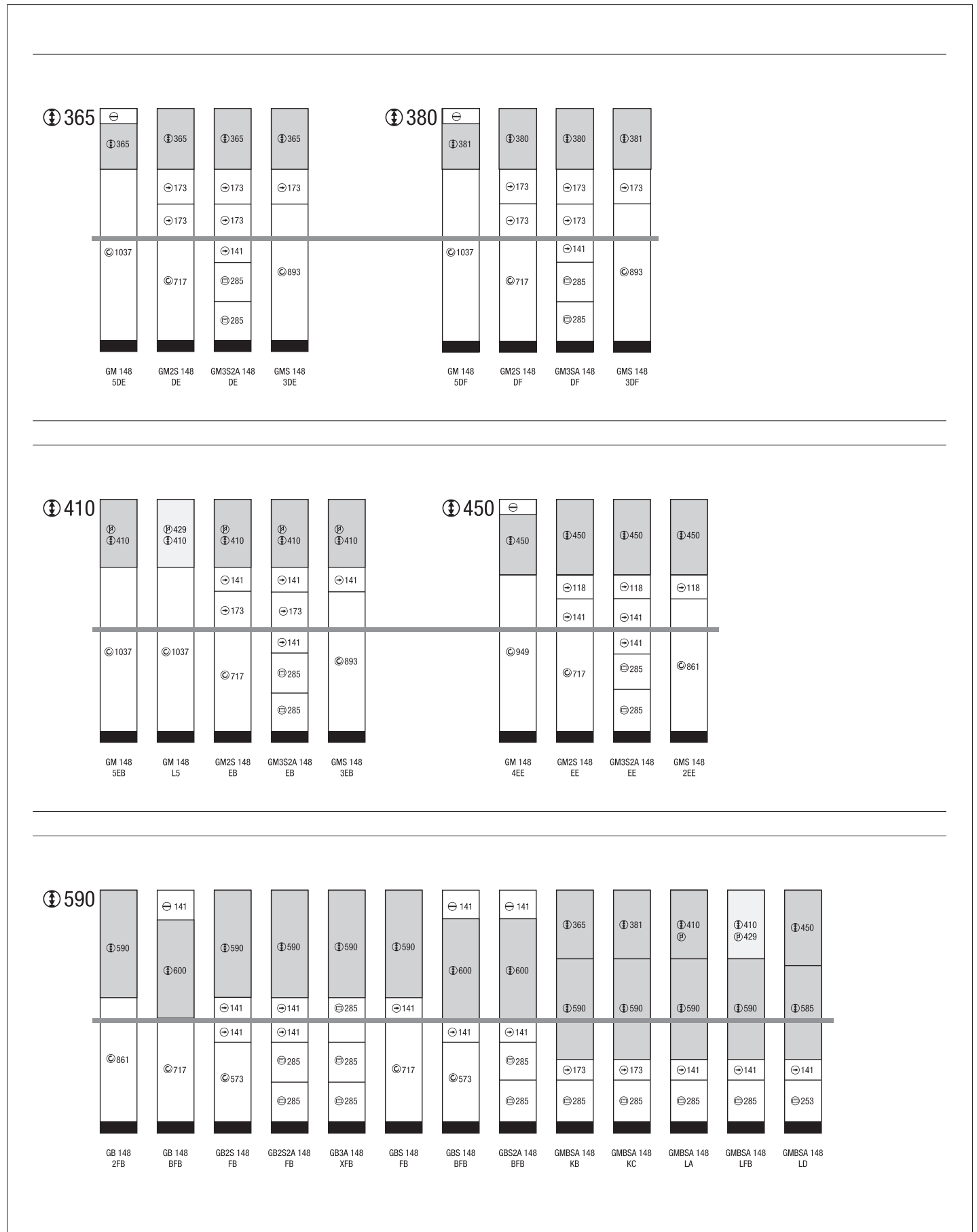

Information on highboards for integrated appliances

Sales / Production types 1619 mm

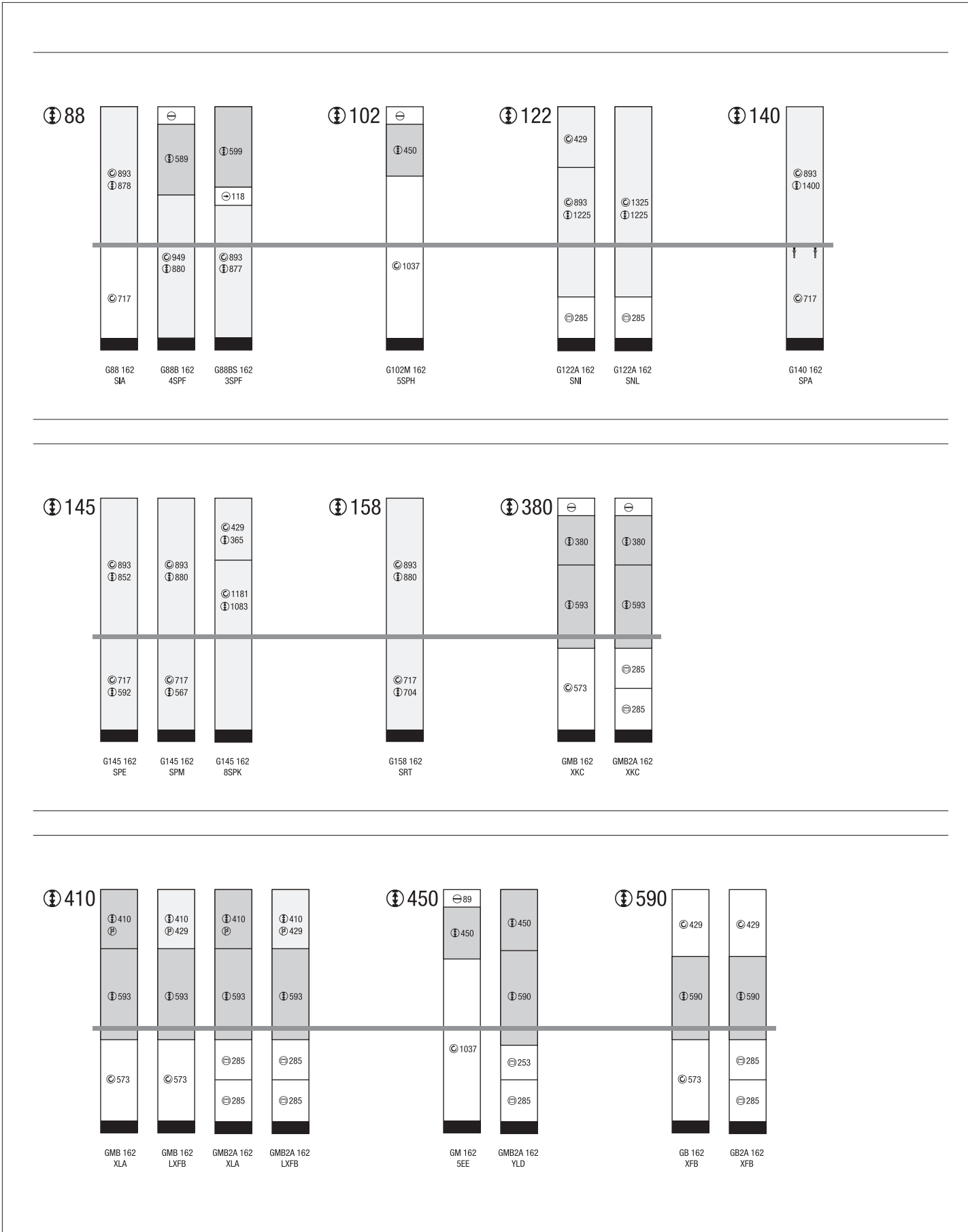

Information on tall units for integrated appliances

Sales / Production types 1907 mm Height 01

88

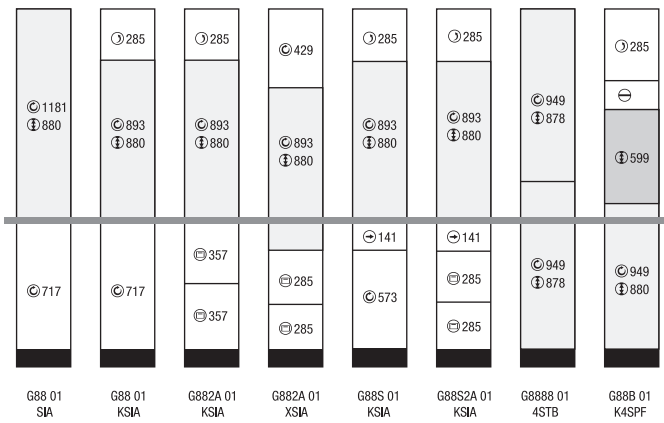

102

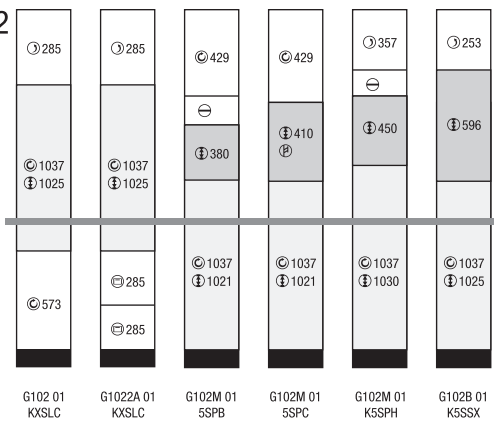

122

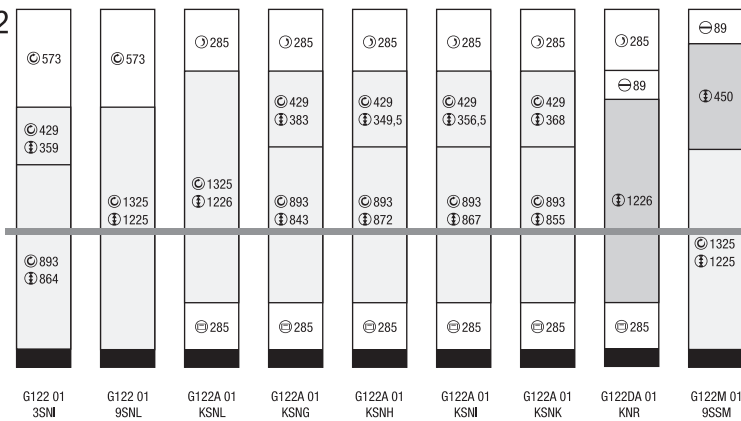

Information on tall units for integrated appliances

Sales / Production types 1907 mm Height 01

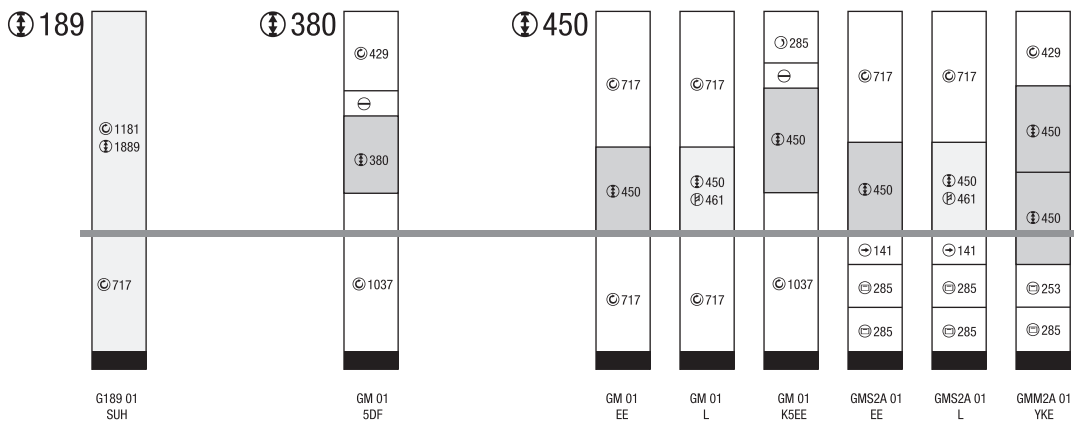
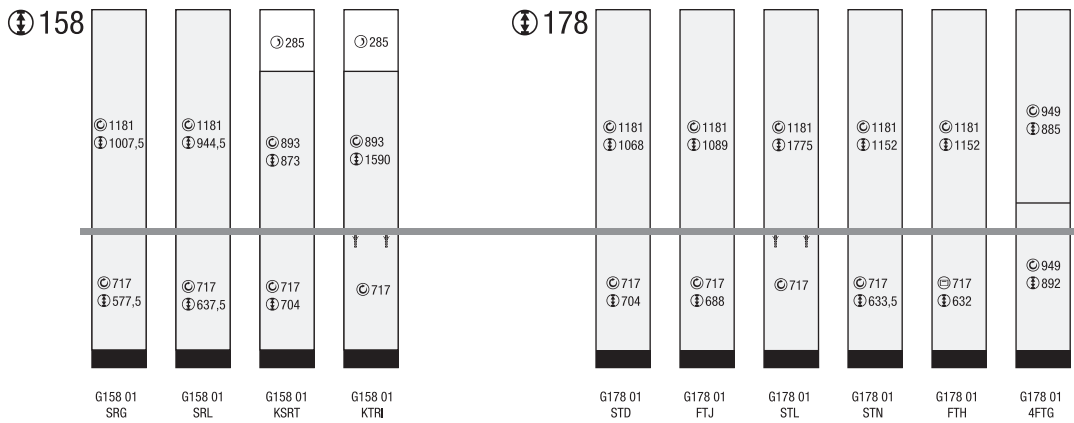
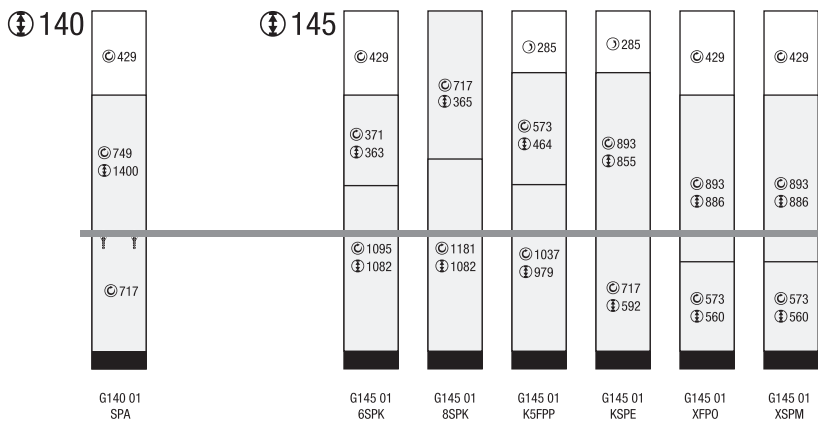

Information on tall units for integrated appliances

Sales / Production types 1907 mm Height 01

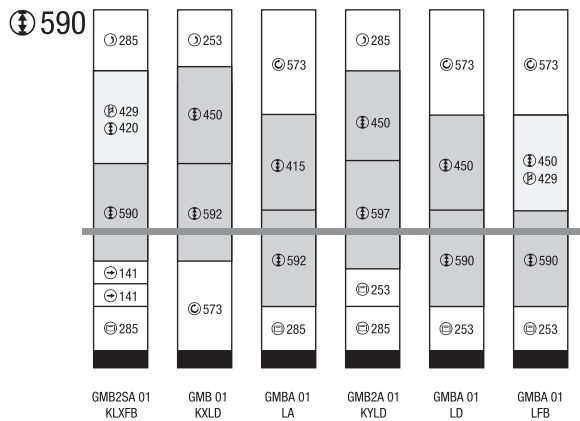
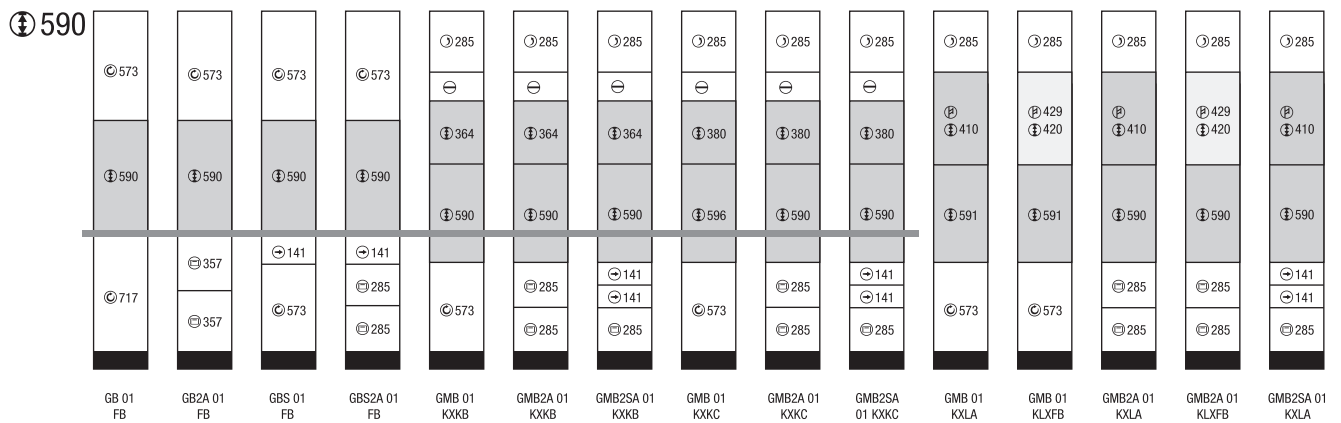

Information on tall units for integrated appliances

Sales / Production types 2051 mm Height 02

88

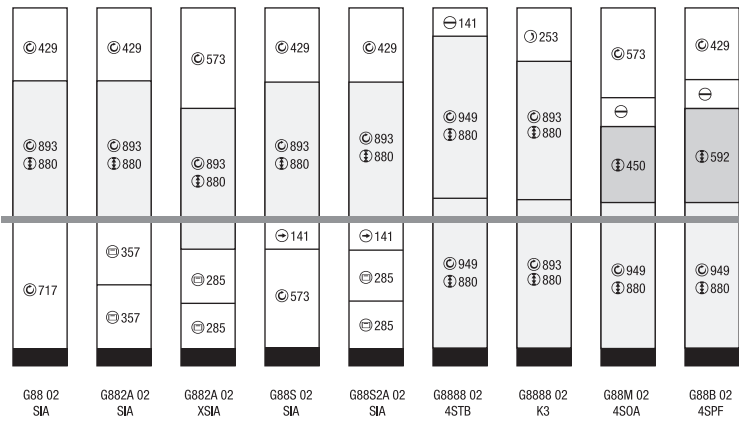

102

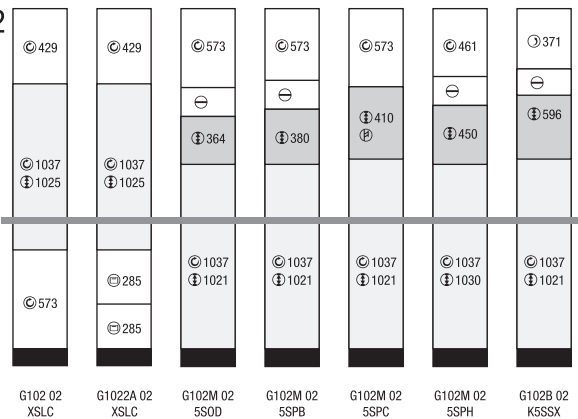

122

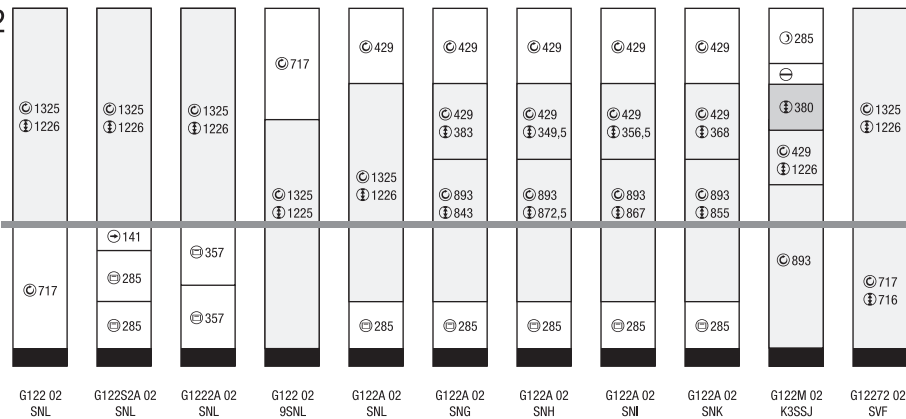

Information on tall units for integrated appliances

Sales / Production types 2051 mm Height 02

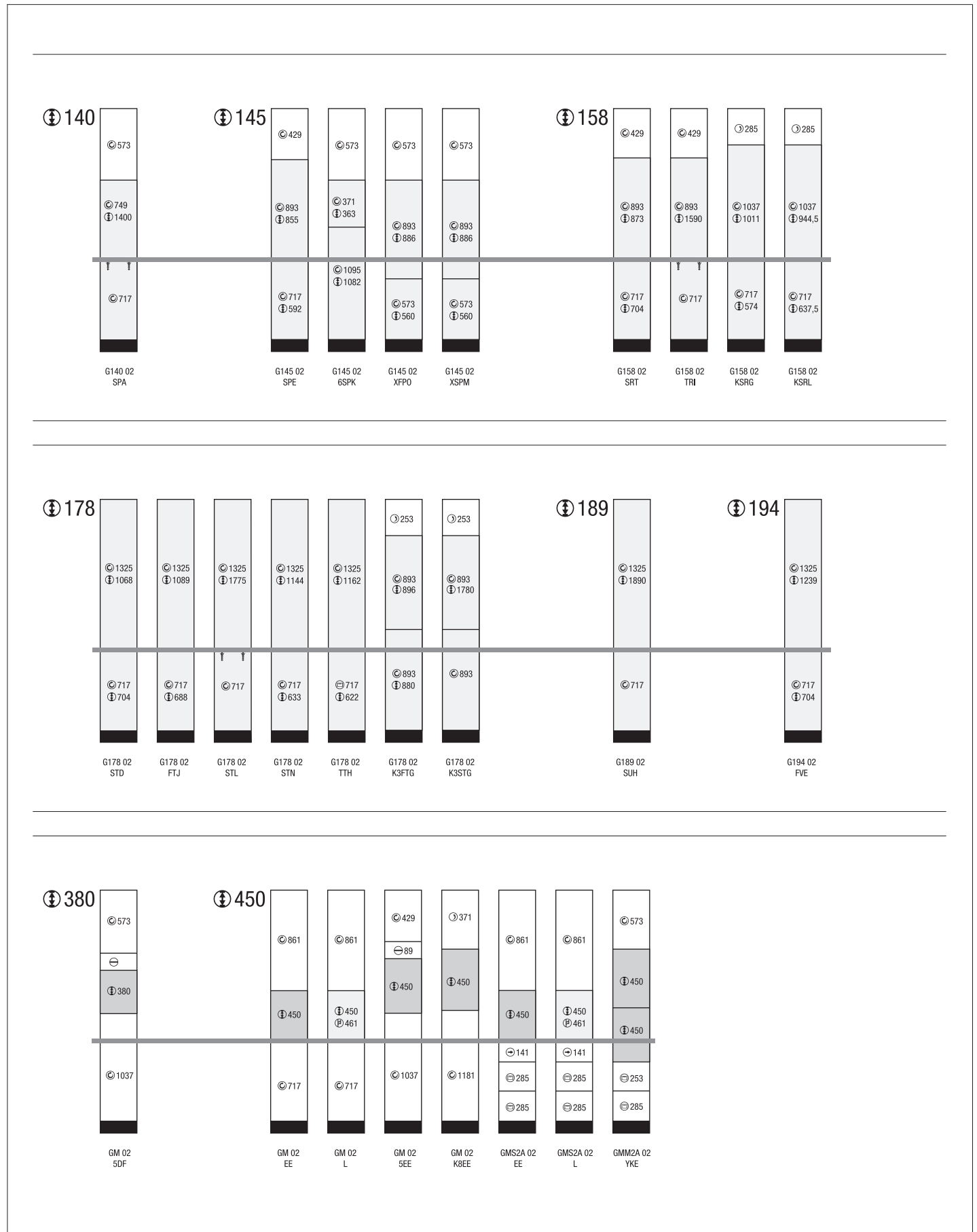

Information on tall units for integrated appliances

Sales / Production types 2051 mm Height 02

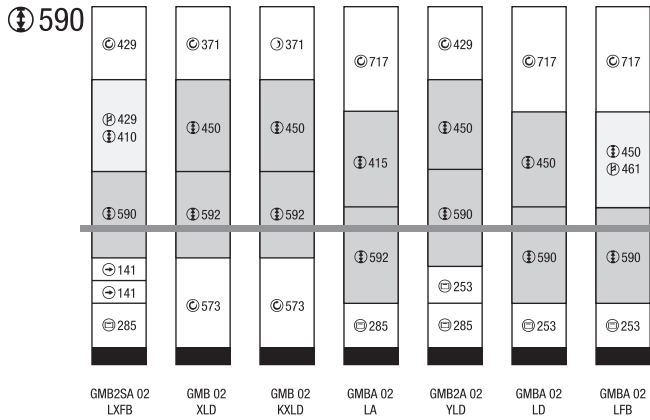
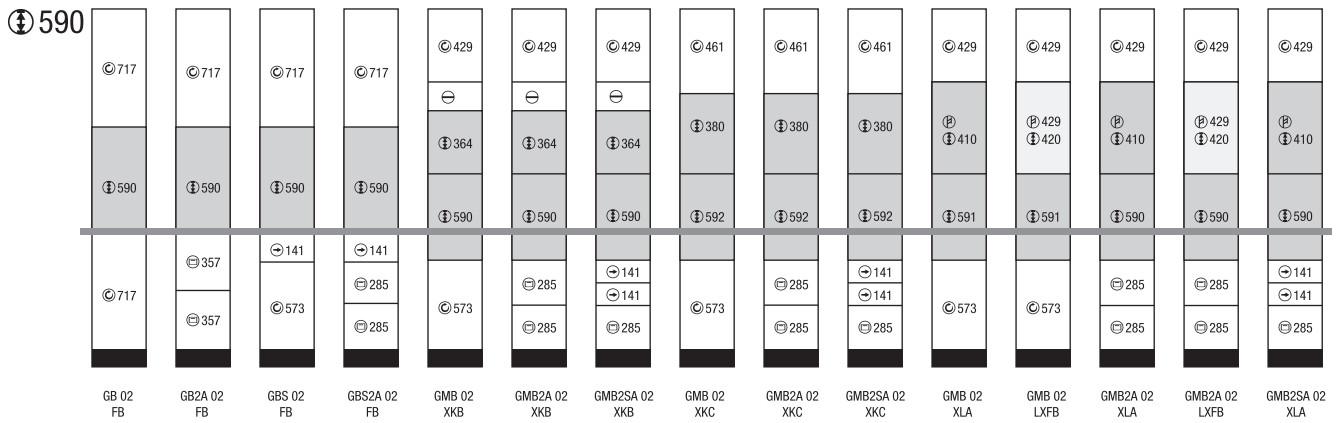

Information on tall units for integrated appliances

Sales / Production types 2195 mm Height 03

88

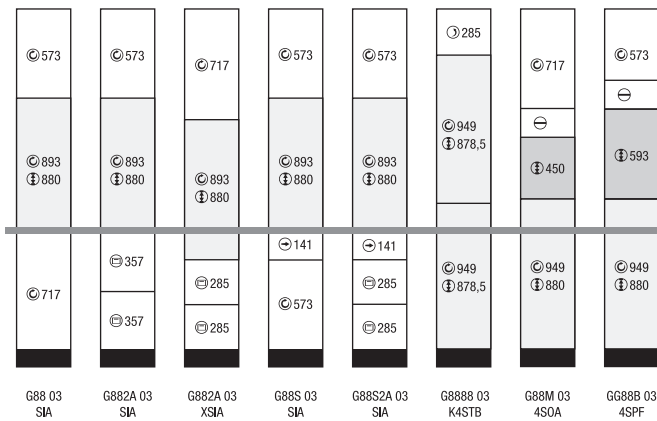

102

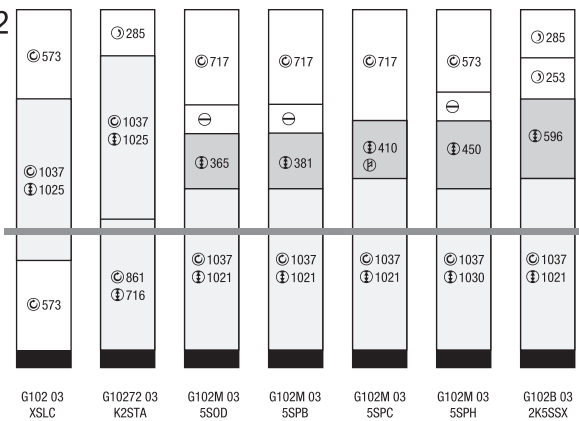

122

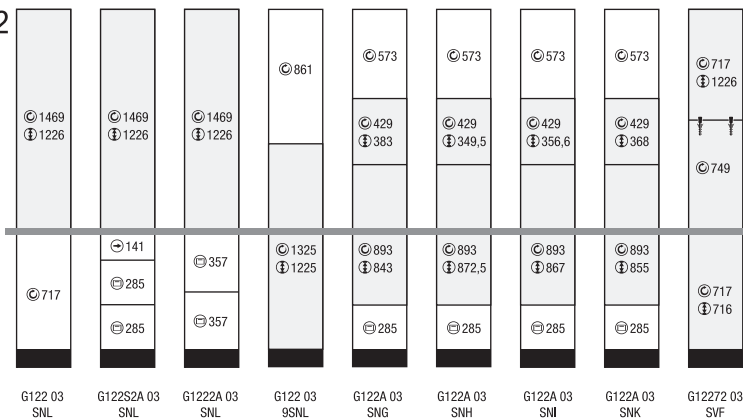

Information on tall units for integrated appliances

Sales / Production types 2195 mm Height 03

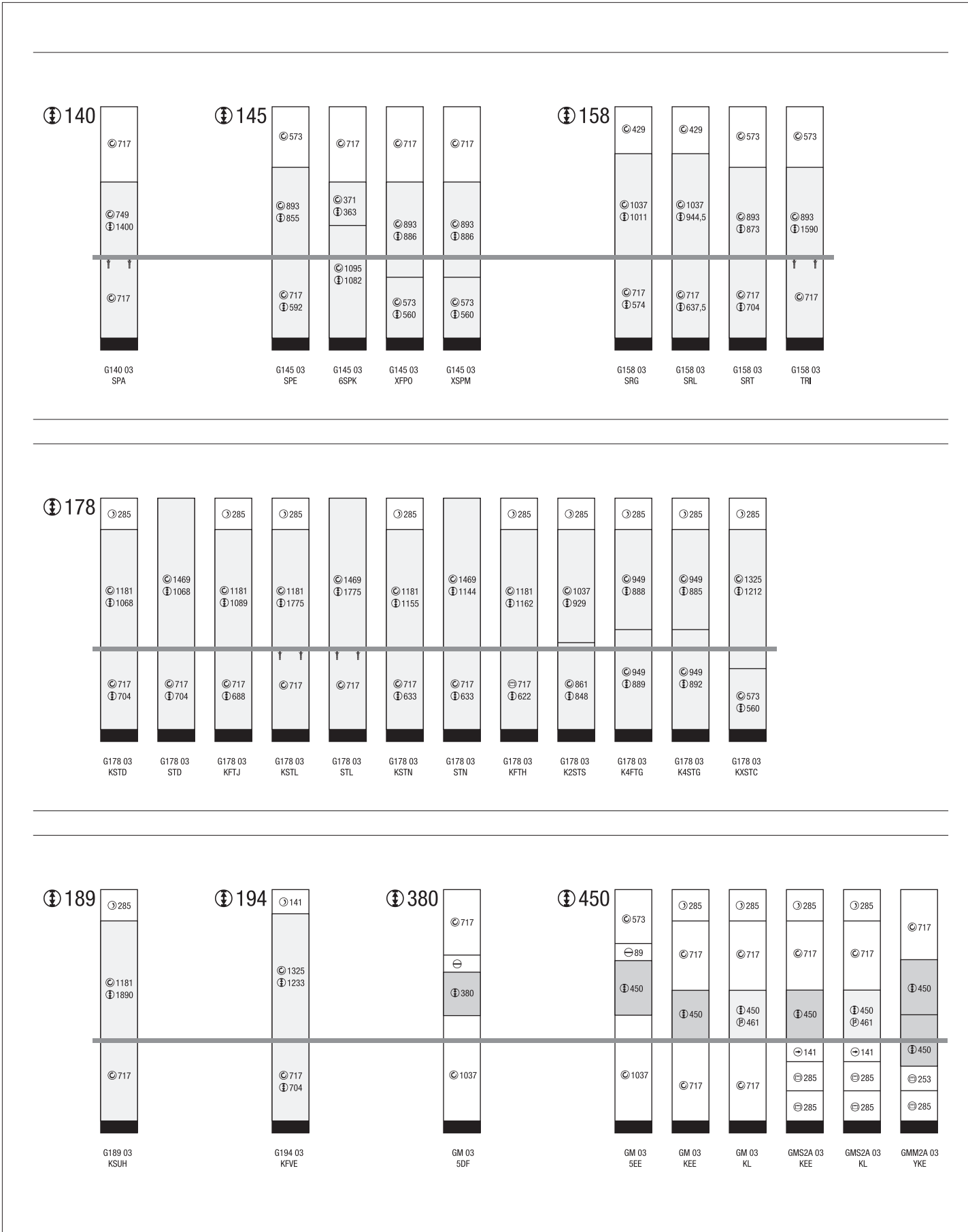

Information on tall units for integrated appliances

Sales / Production types 2195 mm Height 03

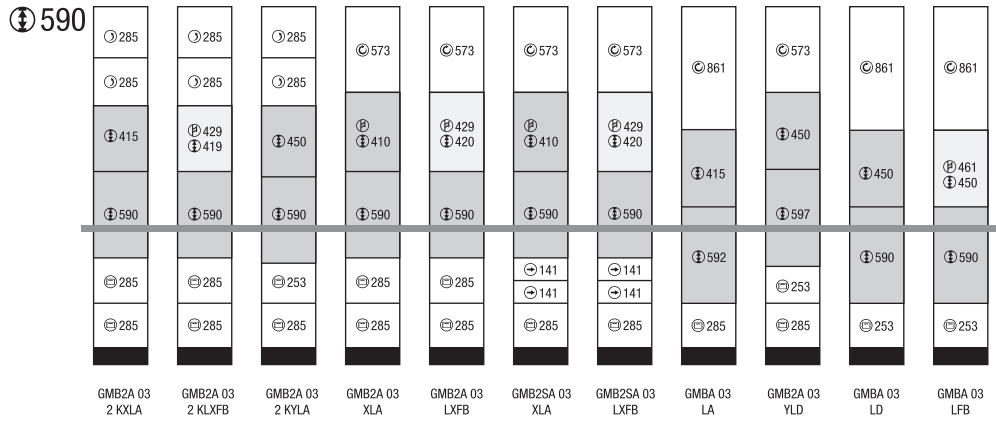
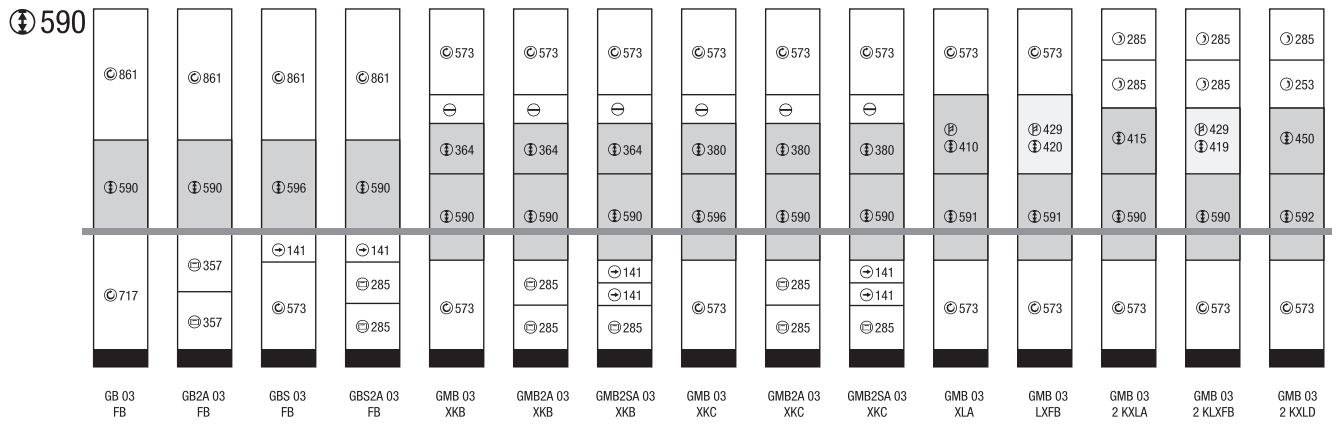

Notes

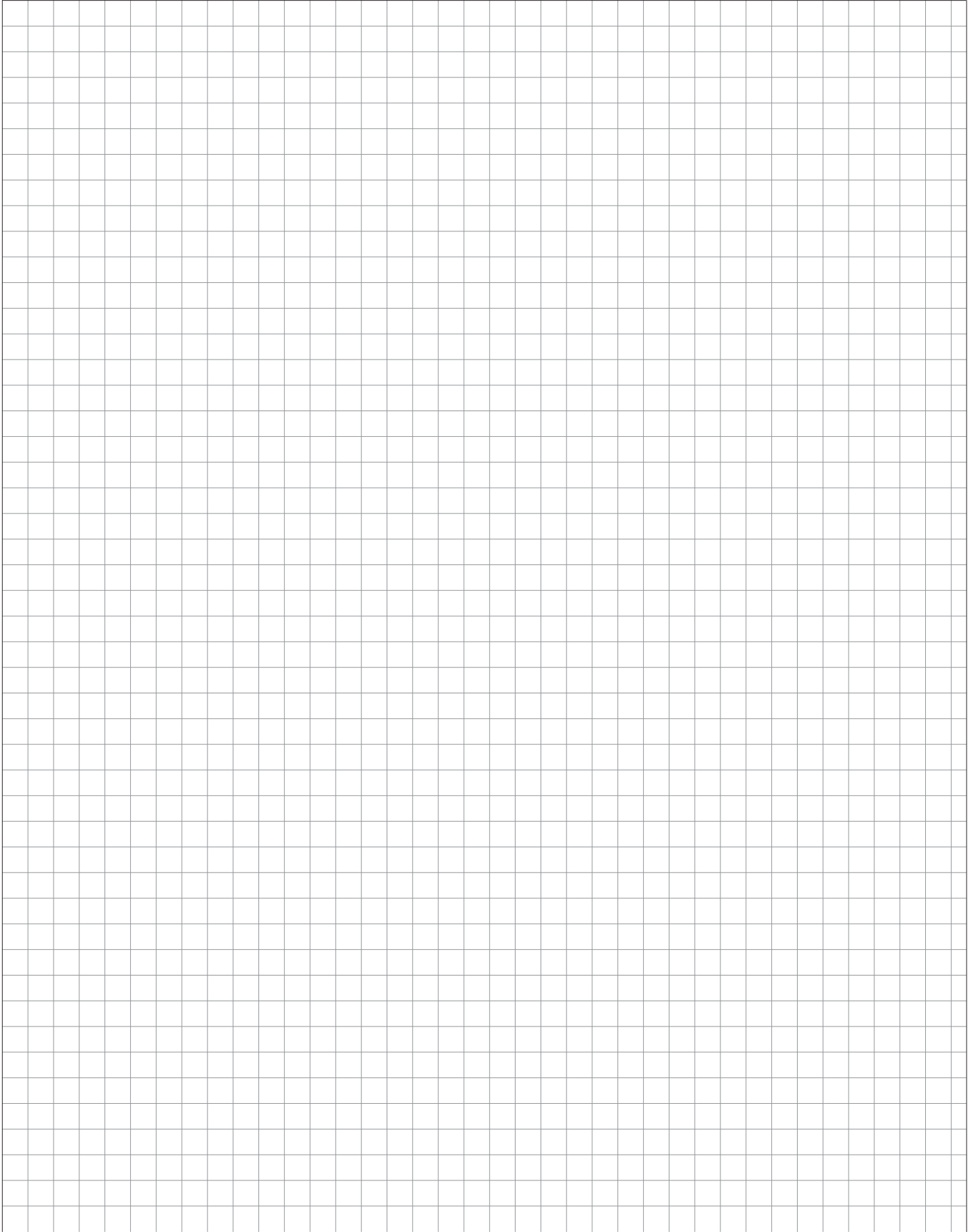

Highboards 1043 mm

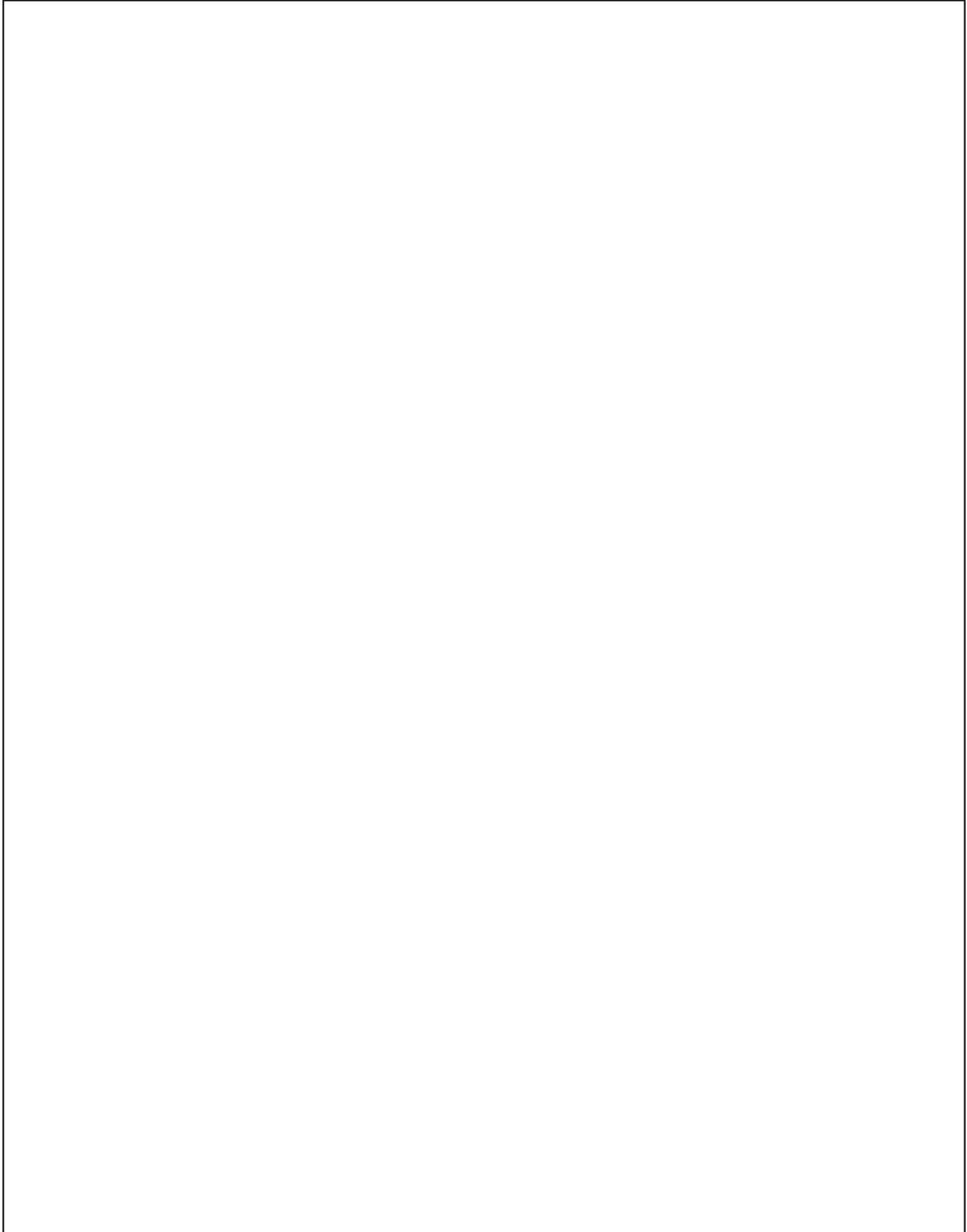

Highboards 1043 mm



Highboards 1043 mm

Highboard

1043 mm high

Unit without worktop and plinth, carcass depth 560 mm. Order worktop separately.

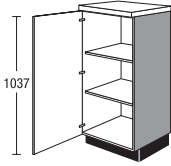
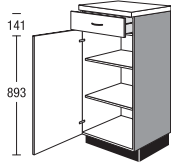
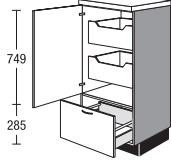



		width		Price group							Servosoft	Pro Servosoft	ProServoglass	Soft closing Top Motion	Soft closing Top Motion Plus	
		60	104	1	2	3	4	5	6	7	-	-	-	6	6	
 <p>Highboard 1 hinged door 2 adjustable shelves <i>Width can be shortened down to 300 mm</i></p>	☑	S	60	104	106	116	125	135	155	175	199	-	-	-	6	6
	☑	SS	30	104	95	99	105	112	126	140	157	5	8	8	4	4
 <p>Highboard 1 drawer 1 hinged door 2 adjustable shelves</p>	☑	SS	60	104	133	139	148	158	179	199	224	5	8	8	4	4
	☑	SA	30	104	136	146	154	165	185	204	228	15	24	48	4	4
 <p>Highboard 1 hinged door 2 interior deep drawers 1 deep drawer <i>The hinged doors must open to an angle of at least 90° (observe handle spacing). Door must not be hinged on side adjacent to the worktop.</i></p>	☑	SA	60	104	178	191	203	216	243	269	302	15	24	48	4	4
	☑	SA	60	104	178	191	203	216	243	269	302	15	24	48	4	4

Illustrations do not correspond to the door finishes.

Highboard

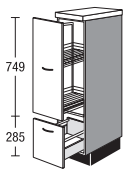
1043 mm high

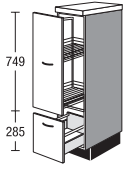
Unit without worktop and plinth, carcass depth 560 mm. Order worktop separately.

		width	Price group							Servosoft	Pro Servosoft	ProServoGlass	Soft closing Top Motion	Soft closing Top Motion Plus		
			1	2	3	4	5	6	7							
 <p>Pull-out larder highboard with cushioning 1 full-extension pull-out with cushioning 2 adjustable wire baskets 1 deep drawer <i>Handle only fitted horizontally</i></p>  <p>Baskets: clip-on baskets silver grey</p> <p>Suitable additions:</p> <p>Hanging basket silver-grey 2 each</p>	SAA	30	104	185	194	196	198	202	210	224	25	28	36	-	-	
		ZIK 30 S2			10	10	10	10	10	10	10	-	-	-	-	-
 <p>Pull-out larder highboard with cushioning 1 full-extension pull-out with cushioning, 2 baskets included 1 full-extension pull-out with cushioning <i>Handle only fitted horizontally</i> <i>Runner profile at bottom. Baskets can be used from both sides.</i></p>  <p>Baskets: clip-on baskets silver grey</p> <p>Suitable additions:</p> <p>Hanging basket silver-grey</p> <p>Insert tray plastic white 12 mm high</p>	SAA	30	104	J	214	224	227	229	234	243	259	5	8	16	-	-
		ZIK	30		6	6	6	6	6	6	6	-	-	-	-	-
		ZIE	30		3	3	3	3	3	3	3	-	-	-	-	-

Highboard

1043 mm high

Unit without worktop and plinth, carcass depth 560 mm. Order worktop separately.

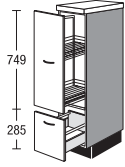
				width		Price group											
						1	2	3	4	5	6	7	Servosoft	Pro Servosoft	ProServodglass	Soft closing Top Motion	Soft closing Top Motion Plus
 <p>Pull-out larder highboard with cushioning</p> <p>1 full-extension pull-out with cushioning, 2 baskets included 1 full-extension deep drawer</p> <p><i>Runner profile at bottom. Baskets can be used from both sides.</i></p> <p><i>Basket features: Comfortline, wooden base with metal railing</i></p> <p><i>Handle only fitted horizontally</i></p> <p><i>Supplementary unit information: Including full pull-out with cushioning</i></p> <p>Suitable additions:</p> <p>Hanging basket Wooden shelf with metal rail</p>	SAA	30	104	JP	225	236	238	241	246	256	273	5	8	16	-	-	
	ZIK	30	P		7	7	7	7	7	7	7	7	-	-	-	-	-

Illustrations do not correspond to the door finishes.

Appliance housings with niche height 880 mm, Appliance housings with niche height 1025 mm, Appliance housings with niche height 450 mm

1043 mm high

Unit without worktop and plinth, carcass depth 560 mm. Order worktop separately.

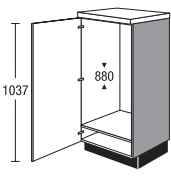
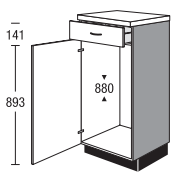
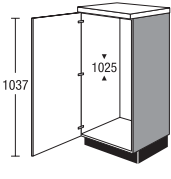
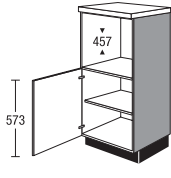
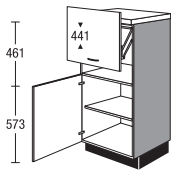
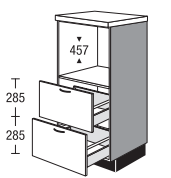
	width	Price group							Servosoft	Pro Servosoft	ProServoGlass	Soft closing Top Motion	Soft closing Top Motion Plus		
		1	2	3	4	5	6	7							
 <p>Highboard for built-in appliances Niche height 880 mm 1 hinged appliance door <i>Niche size may be adjusted with internal infill panel or intermediate shelf</i> <i>Ventilation grills for unit ventilation are included in the delivery.</i></p>	G88	104	5	105	115	123	132	152	171	194	-	-	-	6	6
 <p>Highboard for built-in appliances Niche height 880 mm 1 drawer 1 hinged appliance door <i>Niche size may be adjusted with internal infill panel or intermediate shelf</i> <i>Ventilation grills for unit ventilation are included in the delivery.</i></p>	G88S	104	3	119	125	134	144	165	185	210	5	8	8	4	4
 <p>Highboard for built-in appliances niche height 1025 mm 1 hinged appliance door 1 metal plinth shelf <i>Ventilation grills for unit ventilation are included in the delivery.</i></p>	G102	104	5	121	131	139	148	168	187	211	-	-	-	6	6
 <p>Highboard for built-in appliances niche height 457 mm 1 hinged door 1 adjustable shelf</p>	GM	104	X	109	119	128	137	158	178	202	-	-	-	4	4
 <p>Highboard for built-in appliances with lift-up door Recess height 441 mm same as above, but plus 1 lift-up door Maximum size of stand-alone Height 400 mm Width 510 mm Depth: 540 430 mm opening height for lift-up door <i>To be able to open the lift-up door, the top panel must not overhang by more than 28 mm.</i></p>	GM	104	LX	179	195	210	225	259	292	332	-	-	-	4	4
 <p>Highboard for built-in appliances niche height 457 mm 2 deep drawers</p>	GM2A	104	X	140	157	167	178	209	237	275	10	16	32	-	-

4.24 Illustrations do not correspond to the door finishes.

Appliance housings with niche height 450 mm, Appliance housings with niche height 590 mm

1043 mm high

Unit without worktop and plinth, carcass depth 560 mm. Order worktop separately.

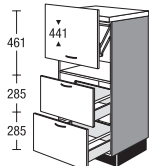
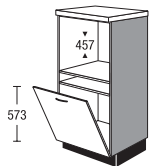
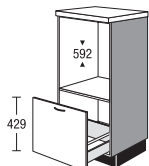
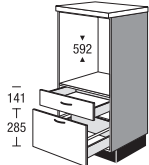
	width	Price group							Servosoft	Pro Servosoft	ProServoglass	Soft closing Top Motion	Soft closing Top Motion Plus	
		1	2	3	4	5	6	7						
 <p>Highboard for built-in appliances with lift-up door Recess height 441 mm same as above, but plus 1 lift-up door</p> <p>Maximum size of stand-alone Height 400 mm Width 510 mm Depth: 540</p> <p>430 mm opening height for lift-up door</p> <p><i>To be able to open the lift-up door, the top panel must not overhang by more than 28 mm.</i></p>	GM2A	104 LX	210	236	251	267	314	356	413	10	16	32	-	-
 <p>Highboard for built-in appliances niche height 457 mm niche height 458 mm 1 front panel for fully integrated dishwashers 1 fixed shelf</p>	GMG	104 X	130	142	153	165	197	206	223	-	-	-	-	-
 <p>Highboard for built-in appliances Niche height 592 mm 1 deep drawer</p> <p><i>For foil-wrapped fronts a set of heat deflector plates are supplied free of charge.</i></p>	GBA	104	115	132	142	153	184	212	249	5	8	16	-	-
 <p>Highboard for built-in appliances Niche height 592 mm 1 drawer 1 deep drawer</p> <p><i>For foil-wrapped fronts a set of heat deflector plates are supplied free of charge.</i></p>	GBSA	104	131	141	149	158	178	200	227	10	16	24	-	-

Illustrations do not correspond to the door finishes.

Highboard shelf units

1043 mm high

Unit without worktop and plinth, carcass depth 560 mm. Order worktop separately.

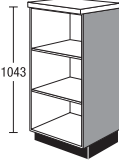
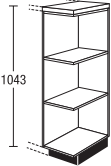
				width	Price group							Servosoft	Pro Servosoft	ProServoGlass	Soft closing Top Motion	Soft closing Top Motion Plus
					1	2	3	4	5	6	7					
	<p>Highboard shelf unit</p> <p>2 adjustable shelves</p> <p><i>Finish in carcass material</i></p> <p><i>Please indicate desired width (150-600 mm).</i></p> <p><i>Not available in visible side colours.</i></p>	SR	V	104	172	172	172	172	172	172	172	-	-	-	-	-
	 <p>Version R</p> <p>Angled shelf</p> <p>2 fixed shelves</p> <p><i>Measurements with worktop 290 mm</i> <i>Measurements with modular panel 275 mm</i></p> <p><i>Finish in carcass material</i></p> <p><i>Available in all carcass finishes.</i></p> <p><i>Additional colour variants:</i> 112 Cappuccino 121 Thyme 133 Volcano brown 134 Alby Blue 158 Sage green 952 Petrol</p> <p><i>Not available in visible side colours.</i></p>	SRA	30	104	129	129	129	129	129	129	129	129	-	-	-	-

Filler panels, Miscellaneous

1043 mm high

with neutral door division

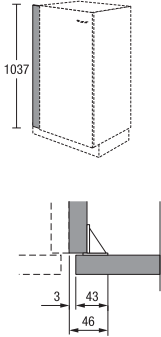
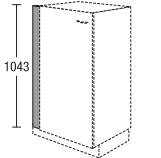
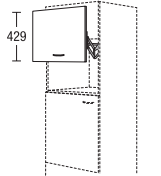
				Price group												
				width	1	2	3	4	5	6	7	Servosoft	Pro Servosoft	ProServoglass	Soft closing Top Motion	Soft closing Top Motion Plus
 <p>Infill panel for highboard without plinth, 1043 mm high</p> <p>Fitted between wall and carcass side</p> <p>Finish in continuous door material without edging on the wall side</p> <p>Not available in visible side colours.</p> <p>Due to the installation angle, the maximum possible on-site width reduction is 46 mm.</p>	SPF	10	104 E		24	28	29	30	31	34	39	-	-	-	-	-
	SPF	20	104 E	31	35	35	36	37	45	56	-	-	-	-	-	
 <p>Infill panel for highboard without plinth, 1043 mm high</p> <p>Finish in carcass material</p> <p>Not available in visible side colours.</p>	SPK	10	104	16	16	16	16	16	16	16	-	-	-	-	-	
	SPK	20	104	22	22	22	22	22	22	22	-	-	-	-	-	
	SPK	30	104	28	28	28	28	28	28	28	-	-	-	-	-	
 <p>Lift-up door for microwave niche for retrofitting on site</p> <p>For tall units / highboards with niche height 410 mm</p> <p>Max. size of standing appliance Height: 370 mm Width: 510 mm Depth: 540 mm</p> <p>370 mm opening height for lift-up door</p>	LKP	60	43	60	63	64	66	73	79	88	-	-	-	-	-	

Illustrations do not correspond to the door finishes.

Notes

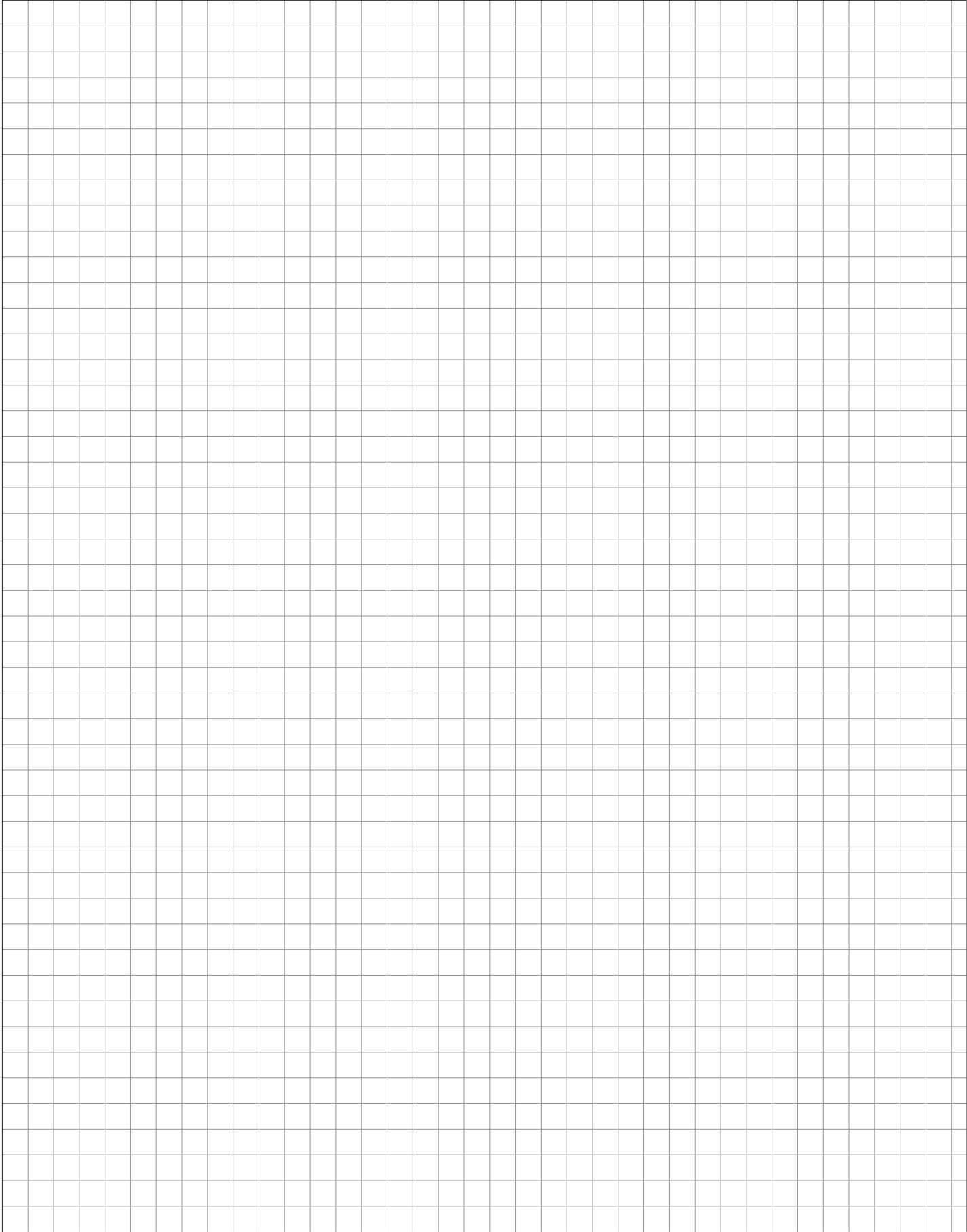

Highboards 1475 mm

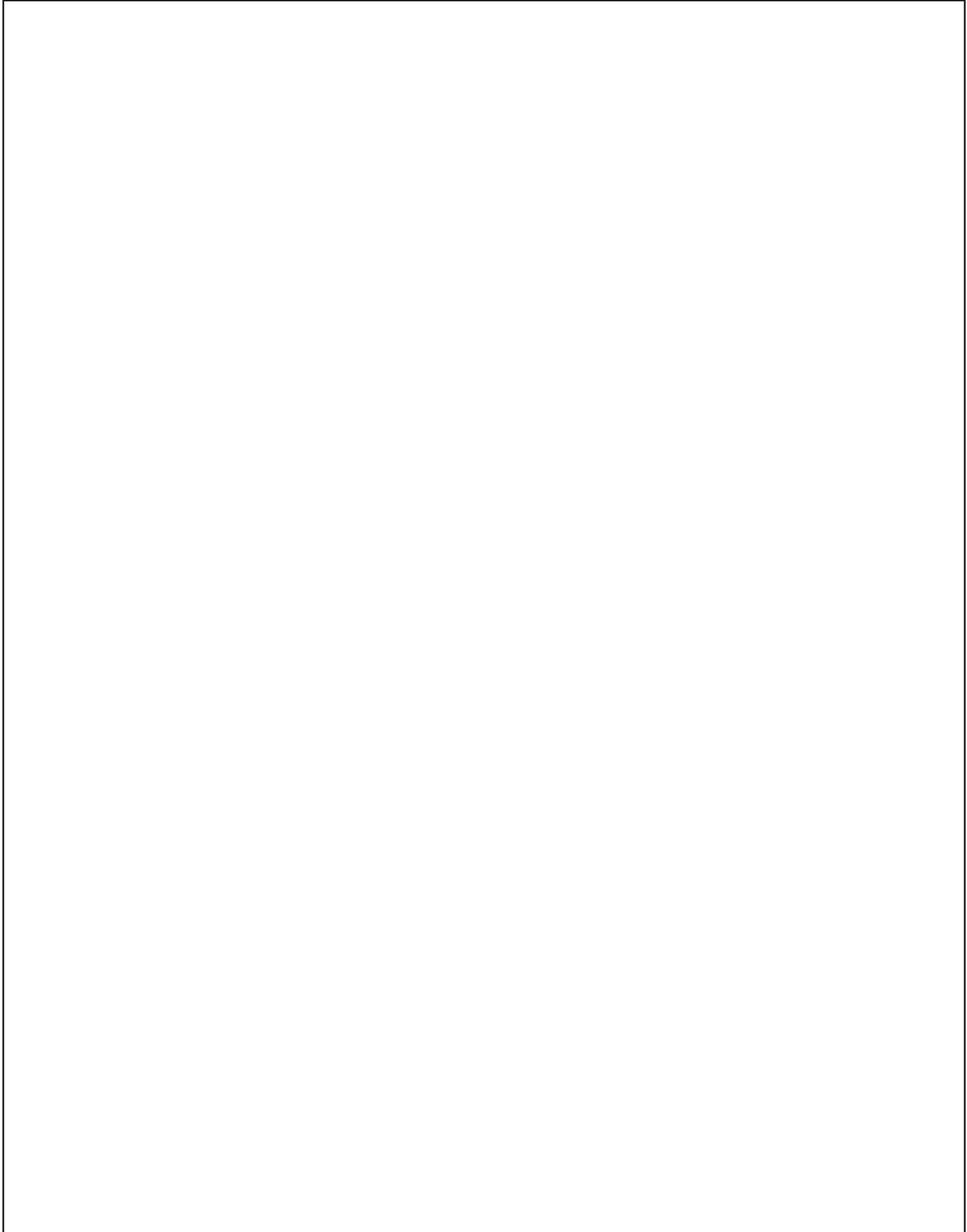

Highboards 1475 mm



Highboards 1475 mm



Highboard

1475 mm high

Unit without worktop and plinth, carcass depth 560 mm. Order worktop separately.

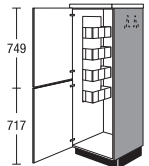
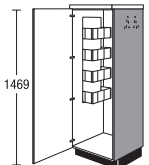
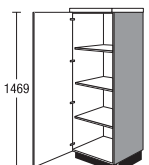
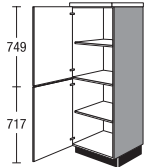
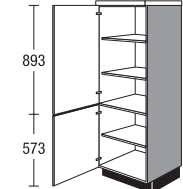
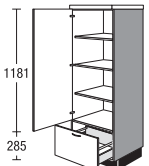
				width	Price group							Servosoft	Pro Servosoft	ProServoglass	Soft closing Top Motion	Soft closing Top Motion Plus			
					1	2	3	4	5	6	7								
	Highboard for brooms 1 door (dowelled) 1 wire shelf 1 hook for brooms 1 universal holder for cable, hose and vacuum cleaner accessories stowage of vacuum cleaner, step ladder or ironing board possible <i>No wire parts if depth is reduced to less than 410 mm.</i> <i>Grip ledges are fitted at the works to both side-hung doors in order to achieve a continuous joint pattern.</i>	<input checked="" type="checkbox"/>	S	60	148	B	124	134	144	154	174	192	215	-	-	-	8	8	
	Highboard for brooms 1 hinged door 1 wire shelf 1 hook for brooms 1 universal holder for cable, hose and vacuum cleaner accessories stowage of vacuum cleaner, step ladder or ironing board possible <i>No wire parts if depth is reduced to less than 410 mm.</i> <i>Available for the following ranges: IP 1200, IP 2200, IP 3150, IP 4050</i>	<input checked="" type="checkbox"/>	S	60	148	EB	123	133	143	153	173	190	213	-	-	-	8	8	
	Highboard 1 hinged door 1 adjustable shelf 1 fixed shelf 1 adjustable shelf <i>Available for the following ranges: IP 1200, IP 2200, IP 3150, IP 4050</i>	<input checked="" type="checkbox"/>	S	30	148	E	99	105	113	-	-	-	-	-	-	-	8	8	
		<input checked="" type="checkbox"/>	S	45	148	E	111	120	129	-	-	-	-	-	-	-	-	8	8
		<input checked="" type="checkbox"/>	S	50	148	E	115	125	133	-	-	-	-	-	-	-	-	8	8
		<input checked="" type="checkbox"/>	S	60	148	E	119	129	138	-	-	-	-	-	-	-	-	8	8
	Highboard 1 hinged door 1 adjustable shelf 1 hinged door 1 adjustable shelf	<input checked="" type="checkbox"/>	S	30	148		100	106	114	122	130	142	158	-	-	-	8	8	
		<input checked="" type="checkbox"/>	S	60	148		120	130	139	149	169	189	214	-	-	-	8	8	
	Highboard 1 hinged door 2 adjustable shelves 1 hinged door 1 adjustable shelf	<input checked="" type="checkbox"/>	S	30	148	X	102	108	116	124	132	144	160	-	-	-	8	8	
		<input checked="" type="checkbox"/>	S	60	148	X	124	134	144	154	175	196	222	-	-	-	8	8	
	Highboard 1 hinged door 3 adjustable shelves 1 deep drawer	<input checked="" type="checkbox"/>	STA	30	148		108	116	124	132	149	166	187	5	8	16	6	6	
		<input checked="" type="checkbox"/>	STA	45	148		120	129	138	147	165	184	206	5	8	16	6	6	
		<input checked="" type="checkbox"/>	STA	50	148		125	134	143	153	172	191	215	5	8	16	6	6	
		<input checked="" type="checkbox"/>	STA	60	148		132	142	151	161	181	201	226	5	8	16	6	6	

Illustrations do not correspond to the door finishes.

Highboard

1475 mm high

Unit without worktop and plinth, carcass depth 560 mm. Order worktop separately.

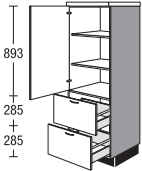
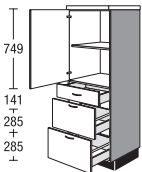
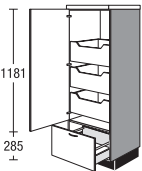
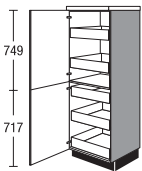
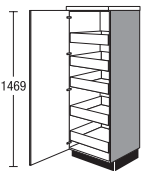
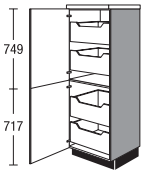
			width	Price group							Servosoft	Pro Servosoft	ProServoGlass	Soft closing Top Motion	Soft closing Top Motion Plus		
				1	2	3	4	5	6	7							
 <p>Highboard 1 hinged door 2 adjustable shelves 2 deep drawers</p>	<input checked="" type="checkbox"/>	S2A	30	148	X	128	137	146	156	175	194	218	10	16	32	4	4
	<input checked="" type="checkbox"/>	S2A	60	148	X	158	170	181	192	216	240	270	10	16	32	4	4
 <p>Highboard 1 hinged door 1 adjustable shelf 1 drawer 2 deep drawers</p>	<input checked="" type="checkbox"/>	SS2A	30	148		148	159	169	180	202	225	252	15	24	40	4	4
	<input checked="" type="checkbox"/>	SS2A	60	148		181	195	208	221	248	276	309	15	24	40	4	4
 <p>Highboard 1 hinged door 3 interior deep drawers 1 deep drawer</p> <p><i>When planning at the beginning of a wall, it must be possible to open the hinged doors by 90° (observe handle distance) Door must not be hinged on side adjacent to the worktop.</i></p>	<input checked="" type="checkbox"/>	SA	30	148	IA	176	189	202	215	243	271	304	20	32	64	6	6
	<input checked="" type="checkbox"/>	SA	45	148	IA	194	209	223	238	267	297	333	20	32	64	6	6
	<input checked="" type="checkbox"/>	SA	50	148	IA	201	215	230	246	277	307	345	20	32	64	6	6
	<input checked="" type="checkbox"/>	SA	60	148	IA	212	228	243	259	291	323	363	20	32	64	6	6
 <p>Highboard 1 hinged door 2 internal drawers 1 hinged door 3 interior drawers</p> <p><i>The hinged doors must open to an angle of at least 90° (observe handle spacing). Door must not be hinged on side adjacent to the worktop.</i></p>	<input checked="" type="checkbox"/>	S	30	148	IS	191	201	212	222	245	267	295	25	40	40	8	8
	<input checked="" type="checkbox"/>	S	60	148	IS	228	240	252	264	290	315	349	25	40	40	8	8
 <p>Highboard 1 hinged door 5 internal drawers</p> <p><i>The hinged doors must open to an angle of at least 90° (observe handle spacing). Door must not be hinged on side adjacent to the worktop.</i></p> <p><i>Available for the following ranges: IP 1200, IP 2200, IP 3150, IP 4050</i></p>	<input checked="" type="checkbox"/>	S	30	148	EIS	190	200	211	221	244	266	293	25	40	40	8	8
	<input checked="" type="checkbox"/>	S	45	148	EIS	200	211	222	233	256	279	308	25	40	48	6	6
	<input checked="" type="checkbox"/>	S	50	148	EIS	206	218	229	241	265	288	319	25	40	48	6	6
	<input checked="" type="checkbox"/>	S	60	148	EIS	227	239	251	263	289	314	347	25	40	40	8	8
 <p>Highboard 1 hinged door 2 interior deep drawers 1 hinged door 2 interior deep drawers</p> <p><i>The hinged doors must open to an angle of at least 90° (observe handle spacing). Door must not be hinged on side adjacent to the worktop.</i></p>	<input checked="" type="checkbox"/>	S	30	148	IA	176	186	201	215	228	250	277	20	32	64	8	8
	<input checked="" type="checkbox"/>	S	60	148	IA	212	230	246	263	299	334	378	20	32	64	8	8

4.30 Illustrations do not correspond to the door finishes.

Highboard

1475 mm high

Unit without worktop and plinth, carcass depth 560 mm. Order worktop separately.

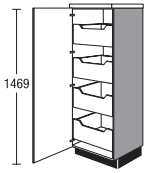
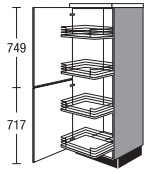
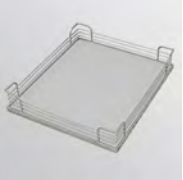

				width	Price group							Servosoft	Pro Servosoft	ProServodglass	Soft closing Top Motion	Soft closing Top Motion Plus		
					1	2	3	4	5	6	7							
 <p>Highboard 1 hinged door 4 interior drawers</p> <p><i>The hinged doors must open to an angle of at least 90° (observe handle spacing). Door must not be hinged on side adjacent to the worktop.</i></p> <p><i>Available for the following ranges: IP 1200, IP 2200, IP 3150, IP 4050</i></p>	NEW	↗	S	30	148	EIA	175	185	200	214	227	249	275	20	32	64	8	8
	NEW	↗	S	45	148	EIA	193	208	222	237	266	295	331	20	32	64	6	6
	NEW	↗	S	50	148	EIA	200	214	229	245	276	305	343	20	32	64	6	6
	NEW	↗	S	60	148	EIA	211	229	245	262	298	332	376	20	32	64	8	8
 <p>Highboard with Tandem Solo 1 hinged door (dowelled) 1 basket trolley with 4 adjustable baskets with wooden shelf and metal rail</p> <p><i>Maximum load per shelf 20 kg.</i></p> 			S	60	148	T	460	474	476	480	486	497	525	-	-	-	8	8

Illustrations do not correspond to the door finishes.

Highboard

1475 mm high

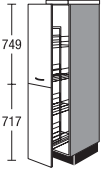

Unit without worktop and plinth, carcass depth 560 mm. Order worktop separately.

	width	Price group							Servosoft	Pro Servosoft	ProServoGlass	Soft closing Top Motion	Soft closing Top Motion Plus		
		1	2	3	4	5	6	7							
 <p>Pull-out larder highboard with wire baskets, silver grey 1 full-extension pull-out with cushioning consisting of 2 fronts 4 adjustable baskets <i>Runner profile top and bottom</i> <i>Grip ledges are fitted at the works to both fronts in order to achieve a continuous joint pattern.</i></p>	SA	30	148	216	232	235	239	246	260	280	36	36	36	-	-
 <p>Baskets: clip-on baskets silver grey</p>															
 <p>Pull-out larder highboard with wire baskets, silver grey 1 full-extension pull-out with cushioning 4 adjustable baskets <i>Runner profile top and bottom</i> <i>Available for the following ranges: IP 1200, IP 2200, IP 3150, IP 4050</i></p>	SA	30	148	E	215	231	234	-	-	-	-	-	-	-	-
<p>Suitable additions:</p>															
<p>Hanging basket silver-grey</p>	ZIK	30		6	6	6	6	6	6	6	-	-	-	-	-
<p>Insert tray plastic white 12 mm high</p>	ZIE	30		3	3	3	3	3	3	3	-	-	-	-	-

Highboard

1475 mm high

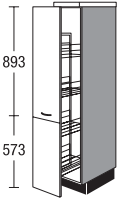
Unit without worktop and plinth, carcass depth 560 mm. Order worktop separately.



			Price group												
			width	1	2	3	4	5	6	7	Servosoft	Pro Servosoft	ProServoglass	Soft closing Top Motion	Soft closing Top Motion Plus
 <p>Pull-out larder highboard with wire baskets, silver grey 1 full-extension pull-out with cushioning consisting of 2 fronts 4 adjustable baskets <i>Runner profile top and bottom</i> <i>Handle only fitted horizontally</i> <i>Grip ledges are fitted at the works to both fronts in order to achieve a continuous joint pattern.</i> <i>Not available for ranges IP 4820, IP 7500</i></p>  <p>Baskets: clip-on baskets silver grey</p> <p>Suitable additions:</p> <p>Hanging basket silver-grey</p> <p>Insert tray plastic white 12 mm high</p>	SA	30	148 X	216	232	235	239	246	260	280	36	36	36	-	-
	ZIK	30		6	6	6	6	6	6	6	-	-	-	-	-
	ZIE	30		3	3	3	3	3	3	3	-	-	-	-	-

Illustrations do not correspond to the door finishes.

Highboard

1475 mm high

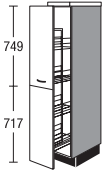



Unit without worktop and plinth, carcass depth 560 mm. Order worktop separately.

		width	Price group							Servosoft	Pro Servosoft	ProServoGlass	Soft closing Top Motion	Soft closing Top Motion Plus	
			1	2	3	4	5	6	7						
 <p>Pull-out larder highboard Baskets with wooden shelf and metal rail 1 full-extension pull-out with cushioning consisting of 2 fronts 4 adjustable baskets</p> <p><i>Runner profile top and bottom Baskets can be used from both sides.</i></p> <p><i>Grip ledges are fitted at the works to both fronts in order to achieve a continuous joint pattern.</i></p> <p>Baskets: wooden shelf and metal rail</p>	SA	30	148	P	304	320	323	327	334	348	372	-	-	-	-
	SA	30	148	EP	303	319	322	-	-	-	-	-	-	-	-
	ZIK	30	P	7	7	7	7	7	7	7	7	7	-	-	-
 <p>Pull-out larder highboard Baskets with wooden shelf and metal rail 1 full-extension pull-out with cushioning 4 adjustable baskets</p> <p><i>Runner profile top and bottom Baskets can be used from both sides.</i></p> <p><i>Available for the following ranges: IP 1200, IP 2200, IP 3150, IP 4050</i></p> <p>Suitable additions:</p> <p>Hanging basket Wooden shelf with metal rail</p>	SA	30	148	PX	304	320	323	327	334	348	372	-	-	-	-
	SA	30	148	PX	304	320	323	327	334	348	372	-	-	-	-
	ZIK	30	P	7	7	7	7	7	7	7	7	7	-	-	-

Highboard

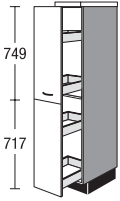
1475 mm high

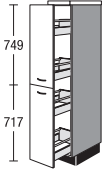
Unit without worktop and plinth, carcass depth 560 mm. Order worktop separately.

				width	Price group							Servosoft	Pro Servosoft	ProServoglass	Soft closing Top Motion	Soft closing Top Motion Plus	
					1	2	3	4	5	6	7						
	Highboard 	SA	30	148	S	147	158	160	163	168	177	191	20	32	32	-	-
	<p>top: 1 deep drawer with 2 drawers</p> <p>bottom: 1 deep drawer with 2 drawers</p> <p>Handle only fitted horizontally</p> <p><i>The front panel must be removed to fit handles on ranges IP 4250, IP 7810 CK, IP 7820 CK.</i></p>																
	Highboard  	SA	30	148	A	159	170	172	175	180	189	203	20	32	32	-	-
	<p>top: 1 Auszug mit 2 Auszügen</p> <p>bottom: 1 Auszug mit 2 Auszügen</p> <p>Handle only fitted horizontally</p> <p><i>The front panel must be removed to fit handles on ranges IP 4250, IP 7810 CK, IP 7820 CK.</i></p>																

Illustrations do not correspond to the door finishes.

Highboard angled units

1475 mm high

Unit without worktop and plinth, carcass depth 560 mm. Order worktop separately.

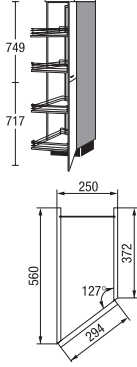
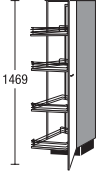
		width	Price group							Servosoft	Pro Servosoft	ProServoGlass	Soft closing Top Motion	Soft closing Top Motion Plus	
			1	2	3	4	5	6	7						
 <p>Diagonal highboard 560/372 mm deep 1 hinged door (dowelled) 1 basket trolley with 4 adjustable baskets</p> <p><i>Measurements with worktop 290 mm Measurements with modular panel 275 mm</i></p> <p><i>Grip ledges are fitted at the works to both fronts in order to achieve a continuous joint pattern.</i></p> <p>Suitable additions:</p> <p>Hanging basket silver-grey</p>	SV	25	148	T	378	397	401	405	425	434	456	-	-	-	-
		ZIK 25 T				11	11	11	11	11	11	11	-	-	-
 <p>Diagonal highboard NEW 560/372 mm deep 1 hinged door 1 basket trolley with 4 adjustable baskets</p> <p><i>Measurements with worktop 290 mm Measurements with modular panel 275 mm</i></p> <p><i>Available for the following fronts: IP 1200, IP 2200, IP 3150, IP 4050</i></p>	SV	25	148	ET	377	396	400	404	424	433	455	-	-	-	-

4.36 Illustrations do not correspond to the door finishes.

Appliance housings with niche height 880 mm

1475 mm high

Unit without worktop and plinth, carcass depth 560 mm. Order worktop separately.

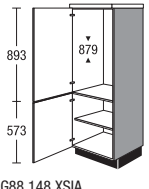
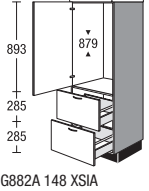
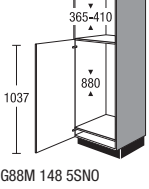
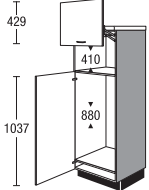
		width	Price group							Servosoft	Pro Servosoft	ProServoglass	Soft closing Top Motion	Soft closing Top Motion Plus
			1	2	3	4	5	6	7					
 <p>Highboard for built-in appliances Niche height 879 mm</p> <p>1 appliance door 1 hinged door 1 adjustable shelf</p> <p><i>Ventilation grills for unit ventilation are included in the delivery.</i></p> <p>G88 148 XSIA</p>	G88	148 X	113	122	129	137	154	174	197	-	-	-	8	8
 <p>Highboard for built-in appliances Niche height 879 mm</p> <p>1 hinged appliance door 2 deep drawers</p> <p><i>Ventilation grills for unit ventilation are included in the delivery.</i></p> <p>G882A 148 XSIA</p>	G882A	148 X	151	163	173	183	206	232	264	10	16	32	4	4
 <p>Highboard for built-in appliances Recess height 365 - 410 mm Niche height 880 mm</p> <p>1 appliance door</p> <p><i>Niche size may be adjusted with internal infill panel or intermediate shelf</i></p> <p><i>One front panel per appliance type will be provided for adaptation on site.</i></p> <p><i>Ventilation grills for unit ventilation are included in the delivery.</i></p> <p>G88M 148 5SNO</p>	G88M	148 5	126	139	148	158	180	201	227	-	-	-	6	6
 <p>Highboard for built-in appliances with lift-up door niche height 410 mm Niche height 880 mm</p> <p>same as above, but plus 1 lift-up door</p> <p>Maximum size of stand-alone Height 370 mm Width 510 mm Depth: 540 mm</p> <p>430 mm opening height for lift-up door</p> <p><i>Niche size may be adjusted with internal infill panel or intermediate shelf</i></p> <p><i>Ventilation grills for unit ventilation are included in the delivery.</i></p> <p><i>To be able to open the lift-up door, the top panel must not overhang by more than 28 mm.</i></p> <p>G88M</p>	G88M	148 L5	191	212	226	242	276	309	350	-	-	-	6	6

Illustrations do not correspond to the door finishes.

Appliance housings with niche height 880 mm, Appliance housings with niche height 1025 mm, Appliance housings with niche height 1225 mm

1475 mm high

Unit without worktop and plinth, carcass depth 560 mm. Order worktop separately.

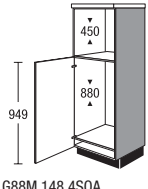
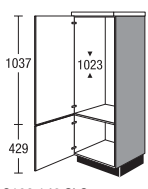
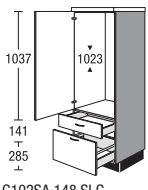
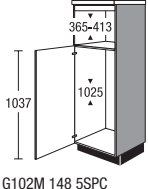
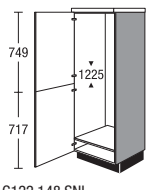
	width	Price group							Servosoft	Pro Servosoft	ProServoGlass	Soft closing Top Motion	Soft closing Top Motion Plus		
		1	2	3	4	5	6	7							
 <p>Highboard for built-in appliances Niche height 450 mm Niche height 880 mm 1 appliance door <i>Niche size may be adjusted with internal infill panel or intermediate shelf</i> <i>One front panel per appliance type will be provided for adaptation on site.</i> <i>Ventilation grills for unit ventilation are included in the delivery.</i></p> <p>G88M 148 4SOA</p>	G88M	148	4	119	131	140	149	170	190	215	-	-	-	6	6
 <p>Highboard for built-in appliances niche height 1023 mm 1 hinged appliance door 1 hinged door <i>Ventilation grills for unit ventilation are included in the delivery.</i></p> <p>G102 148 SLC</p>	G102	148		108	117	125	133	153	171	193	-	-	-	10	10
 <p>Highboard for built-in appliances niche height 1023 mm 1 hinged appliance door 1 drawer 1 deep drawer <i>Ventilation grills for unit ventilation are included in the delivery.</i></p> <p>G102SA 148 SLC</p>	G102SA	148		141	152	161	171	192	216	246	10	16	24	6	6
 <p>Highboard for built-in appliances Recess height 365 - 413 mm niche height 1025 mm 1 appliance door <i>One front panel per appliance type will be provided for adaptation on site.</i> <i>Niche size may be adjusted with internal infill panel or intermediate shelf</i> <i>Ventilation grills for unit ventilation are included in the delivery.</i></p> <p>G102M 148 5SPC</p>	G102M	148	5	142	154	163	172	193	213	238	-	-	-	6	6
 <p>Highboard for built-in appliances niche height 1225 mm 1 hinged appliance door (pinned) <i>Niche size may be adjusted with internal infill panel or intermediate shelf</i> <i>Ventilation grills for unit ventilation are included in the delivery.</i> <i>Grip ledges are fitted at the works to both side-hung doors in order to achieve a continuous joint pattern.</i></p> <p>G122 148 SNL</p>	G122	148		113	123	131	140	160	179	202	-	-	-	8	8

4.38 Illustrations do not correspond to the door finishes.

Appliance housings with niche height 1225 mm, Appliance housings with niche height 1400 mm

1475 mm high

Unit without worktop and plinth, carcass depth 560 mm. Order worktop separately.

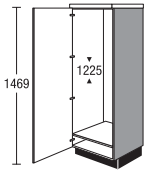
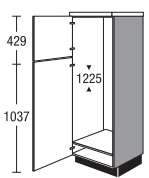
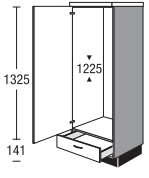
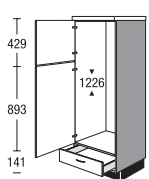
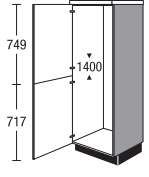
		width	Price group							Servosoft	Pro Servosoft	ProServoglass	Soft closing Top Motion	Soft closing Top Motion Plus		
			1	2	3	4	5	6	7							
 <p>G122 148 ESNL</p>	<p>Highboard for built-in appliances niche height 1225 mm</p> <p>1 appliance door</p> <p><i>Niche size may be adjusted with internal infill panel or intermediate shelf</i></p> <p><i>Ventilation grills for unit ventilation are included in the delivery.</i></p> <p><i>Available for the following ranges: IP 1200, IP 2200, IP 3150, IP 4050</i></p>	G122	148	E	112	122	130	-	-	-	-	-	-	8	8	
 <p>G122 148 5SNI</p>	<p>Highboard for built-in appliances niche height 1225 mm</p> <p>2 hinged appliance doors</p> <p><i>Niche size may be adjusted with internal infill panel or intermediate shelf</i></p> <p><i>Ventilation grills for unit ventilation are included in the delivery.</i></p>	G122	148	5	113	123	131	140	160	179	202	-	-	-	10	10
 <p>G122S 148 SNL</p>	<p>Highboard for built-in appliances niche height 1225 mm</p> <p>1 hinged appliance door</p> <p>1 drawer</p> <p><i>Niche size may be adjusted with internal infill panel or intermediate shelf</i></p> <p><i>Ventilation grills for unit ventilation are included in the delivery.</i></p>	G122S	148		125	131	140	150	171	191	216	5	8	8	6	6
 <p>G122S 148 3SNI</p>	<p>Highboard for built-in appliances Niche height 1226 mm</p> <p>2 hinged appliance doors</p> <p>1 drawer</p> <p><i>Ventilation grills for unit ventilation are included in the delivery.</i></p>	G122S	148	3	137	146	155	166	190	211	240	5	8	8	8	8
 <p>G140 148 SPA</p>	<p>Highboard for built-in appliances Niche height 1400 mm</p> <p>1 hinged appliance door (pinned)</p> <p><i>Niche size may be adjusted with internal infill panel or intermediate shelf</i></p> <p><i>Ventilation grills for unit ventilation are included in the delivery.</i></p>	G140	148		113	123	131	140	160	179	202	-	-	-	8	8

Illustrations do not correspond to the door finishes.

Appliance housings with niche height 1400, 1445, 380, 450 mm

1475 mm high

Unit without worktop and plinth, carcass depth 560 mm. Order worktop separately.

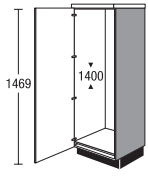
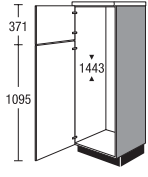
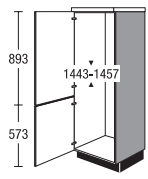
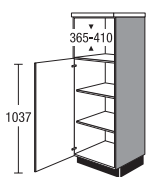
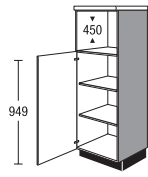
	width	Price group							Servosoft	Pro Servosoft	ProServoGlass	Soft closing Top Motion	Soft closing Top Motion Plus		
		1	2	3	4	5	6	7							
 <p>Highboard for built-in appliances NEW Niche height 1400 mm 1 appliance door <i>Niche size may be adjusted with internal infill panel or intermediate shelf</i> <i>Ventilation grills for unit ventilation are included in the delivery.</i></p> <p>G140 148 E SPA</p>	G140	148	E	108	118	125	134	153	171	193	-	-	-	8	8
 <p>Highboard for built-in appliances Niche height 1443 mm 2 hinged appliance doors <i>Ventilation grills for unit ventilation are included in the delivery.</i></p> <p>G145 148 6SPK</p>	G145	148	6	110	119	127	135	154	172	194	-	-	-	10	10
 <p>Highboard for built-in appliances Recess height 1443 - 1457 mm 2 hinged appliance doors <i>niche height 1457 mm with metal plinth base</i> <i>Ventilation grills for unit ventilation are included in the delivery.</i></p> <p>G145 148 XSPM</p>	G145	148	X	118	128	137	146	167	187	212	-	-	-	8	8
 <p>Highboard for built-in appliances Recess height 365 - 410 mm 1 hinged door 2 adjustable shelves <i>Niche size may be adjusted with internal infill panel or intermediate shelf</i> <i>One front panel per appliance type will be provided for adaptation on site.</i></p> <p>GM148 5DF</p>	GM	148	5	129	140	149	159	181	203	229	-	-	-	6	6
 <p>Highboard for built-in appliances Niche height 450 mm 1 hinged door 2 adjustable shelves <i>One front panel per appliance type will be provided for adaptation on site.</i></p> <p>GM 148 4EE</p>	GM	148	4	121	131	140	149	170	190	215	-	-	-	6	6

4.40 Illustrations do not correspond to the door finishes.

Appliance housings with niche height 450 mm, Appliance housings with niche height 590 mm

1475 mm high

Unit without worktop and plinth, carcass depth 560 mm. Order worktop separately.

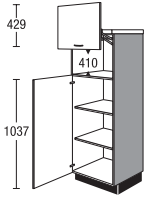
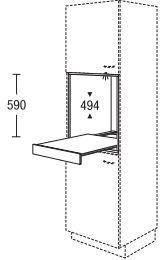
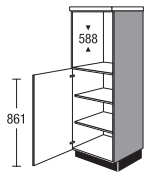
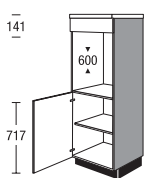
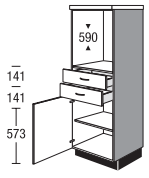
	width	Price group							Servosoft	Pro Servosoft	ProServodiamond	Soft closing Top Motion	Soft closing Top Motion Plus		
		1	2	3	4	5	6	7							
 <p>Highboard for built-in appliances niche height 410 mm with lift-up door same as above, but plus 1 lift-up door</p> <p>Maximum size of stand-alone Height 340 mm Width 510 mm Depth: 540 mm</p> <p>430 mm opening height for lift-up door</p> <p><i>To be able to open the lift-up door, the top panel must not overhang by more than 28 mm.</i></p>	GM	148	L5	194	211	225	241	275	310	350	-	-	-	6	6
 <p>Modular built in shelf unit for highboard / tall unit for niche heights 590 mm Depth: 505 mm</p> <p>1 pull-out shelf</p> <p><i>Finish in carcass material</i></p> <p><i>Not available in visible side colours.</i></p>	MR	60	59	TA	201	201	201	201	201	201	201	-	-	-	-
 <p>Highboard for built-in appliances niche height 588 mm 1 hinged door 2 adjustable shelves</p> <p><i>For foil-wrapped fronts a set of heat deflector plates are supplied free of charge.</i></p> <p>GB 148 2FB</p>	GB	148	2	109	118	126	135	155	174	197	-	-	-	4	4
 <p>Highboard for built-in appliances niche height 600 mm 1 fixed front panel 1 hinged door 1 adjustable shelf</p> <p><i>For foil-wrapped fronts a set of heat deflector plates are supplied free of charge.</i></p> <p>GB 148 BFB</p>	GB	148	B	111	119	126	135	153	171	194	-	-	-	4	4
 <p>Highboard for built-in appliances niche height 590 mm 2 drawers 1 hinged door 1 adjustable shelf</p> <p><i>For foil-wrapped fronts a set of heat deflector plates are supplied free of charge.</i></p> <p>GB2S 148 FB</p>	GB2S	148		148	161	171	183	210	237	267	10	16	16	4	4

Illustrations do not correspond to the door finishes.

Appliance housings with niche height 590 mm

1475 mm high

Unit without worktop and plinth, carcass depth 560 mm. Order worktop separately.

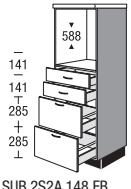
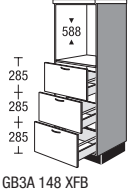
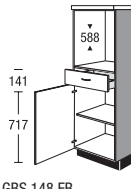
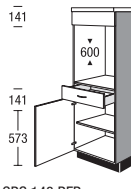
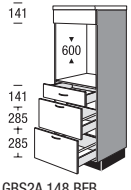
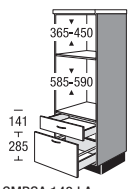
	width	Price group							Servosoft	Pro Servosoft	ProServoGlass	Soft closing Top Motion	Soft closing Top Motion Plus	
		1	2	3	4	5	6	7						
 <p>Highboard for built-in appliances niche height 588 mm 2 drawers 2 deep drawers <i>For foil-wrapped fronts a set of heat deflector plates are supplied free of charge.</i></p> <p>SUB 2S2A 148 FB</p>	GB2S2A	148	173	184	192	201	221	244	273	20	32	48	-	-
 <p>Highboard for built-in appliances niche height 588 mm 3 deep drawers <i>For foil-wrapped fronts a set of heat deflector plates are supplied free of charge.</i></p> <p>GB3A 148 XFB</p>	GB3A	148 X	161	178	188	199	230	258	297	15	24	48	-	-
 <p>Highboard for built-in appliances niche height 588 mm 1 drawer 1 hinged door 1 adjustable shelf <i>For foil-wrapped fronts a set of heat deflector plates are supplied free of charge.</i></p> <p>GBS 148 FB</p>	GBS	148	132	142	151	161	182	203	230	5	8	8	4	4
 <p>Highboard for built-in appliances niche height 600 mm 1 fixed front panel 1 drawer 1 hinged door 1 adjustable shelf <i>For foil-wrapped fronts a set of heat deflector plates are supplied free of charge.</i></p> <p>GBS 148 BFB</p>	GBS	148 B	139	150	159	170	192	214	243	5	8	8	4	4
 <p>Highboard for built-in appliances niche height 600 mm 1 fixed front panel 1 drawer 2 deep drawers <i>For foil-wrapped fronts a set of heat deflector plates are supplied free of charge.</i></p> <p>GBS2A 148 BFB</p>	GBS2A	148 B	157	174	184	195	225	252	291	15	24	40	-	-
 <p>Highboard for built-in appliances Recess height 365 - 450 mm Recess height 585 - 590 mm 1 drawer 1 deep drawer <i>Niche size may be adjusted with internal infill panel or intermediate shelf</i> <i>For foil-wrapped fronts a set of heat deflector plates are supplied free of charge.</i></p> <p>GMBSA 148 LA</p>	GMBSA	148	138	148	156	165	185	207	234	10	16	24	-	-

4.42 Illustrations do not correspond to the door finishes.

Appliance housings with niche height 590 mm

1475 mm high

Unit without worktop and plinth, carcass depth 560 mm. Order worktop separately.

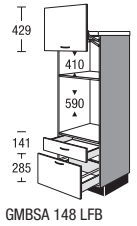
	width	Price group							Servosoft	Pro Servosoft	ProServoGlass	Soft closing Top Motion	Soft closing Top Motion Plus		
		1	2	3	4	5	6	7							
 <p>Highboard for built-in appliances with lift-up door niche height 410 mm niche height 590 mm same as above, but plus 1 lift-up door</p> <p>Maximum size of stand-alone Height 370 mm Width 510 mm Depth: 540 mm</p> <p>430 mm opening height for lift-up door</p> <p><i>To be able to open the lift-up door, the top panel must not overhang by more than 28 mm.</i></p>	GMBSA	148	L	208	223	235	249	279	312	353	10	16	24	-	-

Illustrations do not correspond to the door finishes.

Highboard shelf units

1475 mm high

Unit without worktop and plinth, carcass depth 560 mm. Order worktop separately.

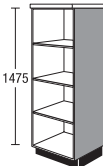
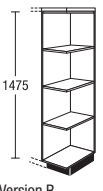
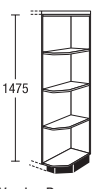
				width	Price group							Servosoft	Pro Servosoft	ProServoGlass	Soft closing Top Motion	Soft closing Top Motion Plus
					1	2	3	4	5	6	7					
	<p>Highboard shelf unit</p> <p>3 adjustable shelves</p> <p><i>Finish in carcass material</i></p> <p><i>Please indicate desired width (150-600 mm).</i></p> <p><i>Not available in visible side colours.</i></p>	SR	V	148	179	179	179	179	179	179	179	-	-	-	-	-
 <p>Version R</p>	<p>Angled shelf</p> <p>3 fixed shelves</p> <p><i>Measurements with worktop 290 mm</i> <i>Measurements with modular panel 275 mm</i></p> <p><i>Finish in carcass material</i></p> <p><i>Available in all carcass finishes.</i></p> <p><i>Additional colour variants:</i> 112 Cappuccino 121 Thyme 133 Volcano brown 134 Alby Blue 158 Sage green 952 Petrol</p> <p><i>Not available in visible side colours.</i></p>	SRA	30	148	138	138	138	138	138	138	138	-	-	-	-	-
 <p>Version R</p>	<p>Angled shelf angled</p> <p>3 fixed shelves</p> <p><i>Finish in carcass material</i></p> <p><i>Measurements with worktop 290 mm</i> <i>Measurements with modular panel 275 mm</i></p> <p><i>Not available in visible side colours.</i></p>	SRA	25	148	S	111	111	111	111	111	111	111	-	-	-	-

4.44 Illustrations do not correspond to the door finishes.

Filler panels, Miscellaneous

1475 mm high

with neutral door division

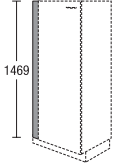
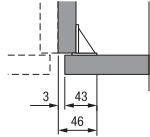
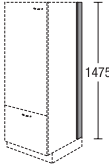
				Price group													
				width	1	2	3	4	5	6	7	Servosoft	Pro Servosoft	ProServoglass	Soft closing Top Motion	Soft closing Top Motion Plus	
	Infill panel for highboard	SPF	10	148	E	25	29	30	31	32	35	40	-	-	-	-	-
	without plinth, 1475 mm high	SPF	20	148	E	33	37	37	38	39	47	58	-	-	-	-	-
<p>Fitted between wall and carcass side</p> <p><i>Finish in continuous door material without edging on the wall side</i></p> <p><i>Not available in visible side colours.</i></p> <p><i>Due to the installation angle, the maximum possible on-site width reduction is 46 mm.</i></p>																	
	Infill panel for highboard	SPK	10	148		17	17	17	17	17	17	17	-	-	-	-	-
	without plinth, 1475 mm high	SPK	20	148		21	21	21	21	21	21	21	-	-	-	-	-
	<i>Finish in carcass material</i>	SPK	30	148		27	27	27	27	27	27	27	-	-	-	-	-
<p><i>Not available in visible side colours.</i></p>																	
	Infill panel for highboard side	SPT	10	148		17	17	17	17	17	17	17	-	-	-	-	-
	without plinth, 1475 mm high	SPT	20	148		20	20	20	20	20	20	20	-	-	-	-	-
	for wall join etc.	SPT	30	148		23	23	23	23	23	23	23	-	-	-	-	-
<p><i>Finish in carcass material</i></p> <p><i>for deeper units, order plinth S0 151 separately</i></p> <p><i>Not available in visible side colours.</i></p>																	

Illustrations do not correspond to the door finishes.

Filler panels, Miscellaneous

1475 mm high

with neutral door division

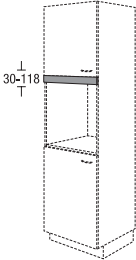
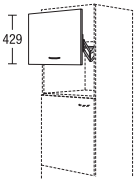
		width		Price group							Servosoft	Pro Servosoft	ProServoGlass	Soft closing Top Motion	Soft closing Top Motion Plus
				1	2	3	4	5	6	7					
 <p>Door material infill panel for appliance housing units For covering the carcass inner panel with edge protection stainless steel coloured Height 30-118 mm <i>Please state the desired height.</i></p>	FBG	60	G	25	29	30	31	33	35	40	-	-	-	-	-
	<p>Door material infill panel for appliance housing units For covering the carcass inner panel with edge protection stainless steel coloured Height 118 mm for on-site adaptation</p>	FBG	60	Z	20	23	24	25	26	28	32	-	-	-	-
 <p>Lift-up door for microwave niche for retrofitting on site For tall units / highboards with niche height 410 mm Max. size of standing appliance Height: 370 mm Width: 510 mm Depth: 540 mm <i>370 mm opening height for lift-up door</i></p>	LKP	60	43	60	63	64	66	73	79	88	-	-	-	-	-

4.46 Illustrations do not correspond to the door finishes.

Highboards 1619 mm

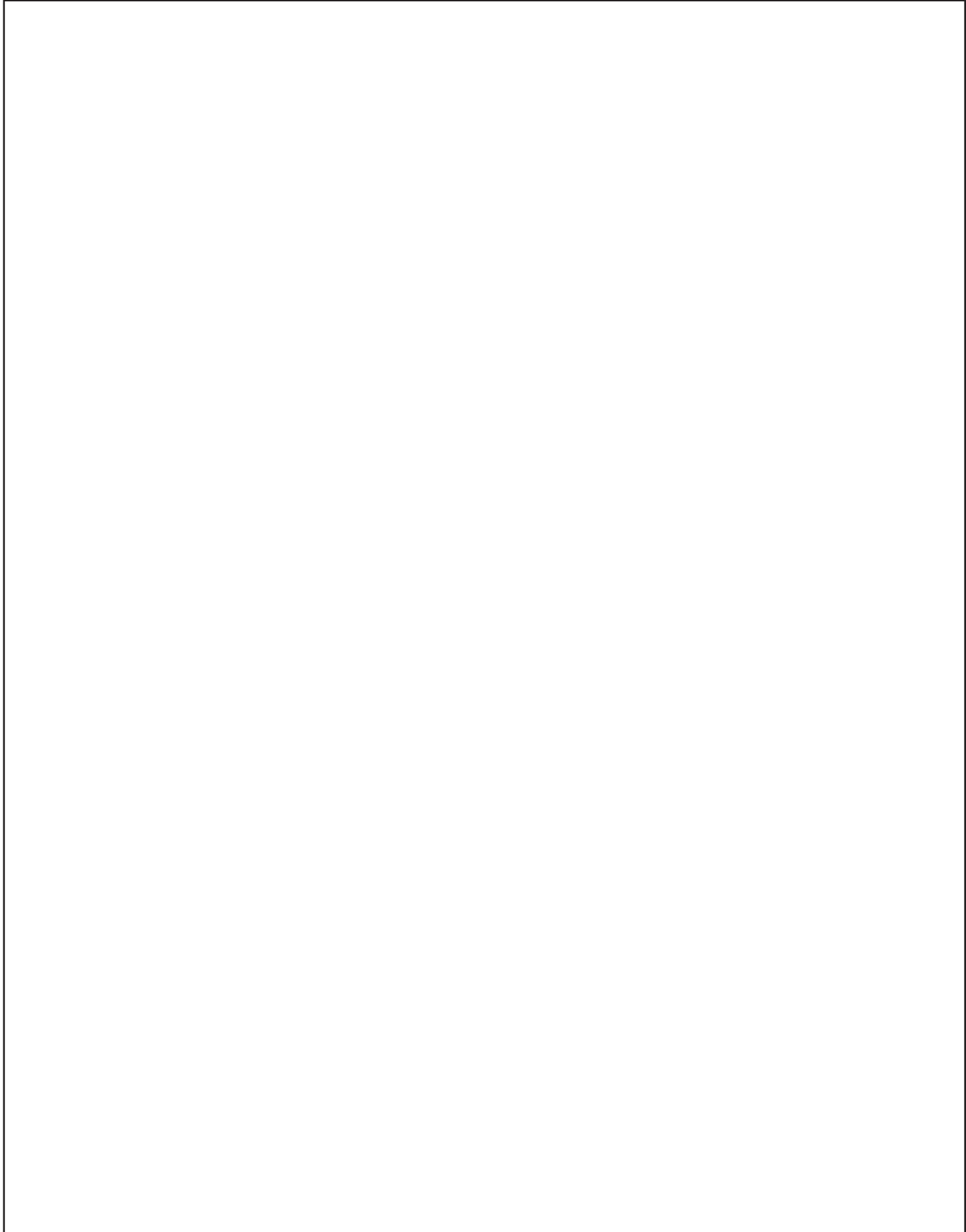

Highboards 1619 mm









Highboards 1619 mm

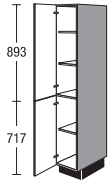

Tall units

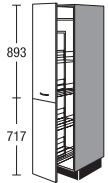
1619 mm high

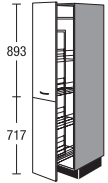
Unit without plinth, carcass depth 560 mm

		width		Price group												
				1	2	3	4	5	6	7	Servosoft	Pro Servosoft	ProServoglass	Soft closing Top Motion	Soft closing Top Motion Plus	
 <p>Tall unit 1 hinged door 2 adjustable shelves 1 hinged door 1 adjustable shelf</p>		S	30	162	113	123	131	139	159	176	198	-	-	-	8	8
		S	60	162	145	155	166	176	199	219	247	-	-	-	8	8
 <p>Pull-out tall unit with wire baskets, silver grey 1 full-extension pull-out with cushioning consisting of 2 fronts 4 adjustable baskets <i>Handle only fitted horizontally</i> <i>Grip ledges are fitted at the works to both fronts in order to achieve a continuous joint pattern.</i></p>  <p>Baskets: clip-on baskets silver grey</p> <p>Suitable additions:</p> <p>Hanging basket silver-grey</p> <p>Insert tray plastic white 12 mm high</p>		SA	30	162	228	242	243	245	258	261	274	36	36	36	-	-
		ZIK	30		6	6	6	6	6	6	6	-	-	-	-	-
		ZIE	30		3	3	3	3	3	3	3	-	-	-	-	-
 <p>Pull-out tall unit Baskets with wooden shelf and metal rail 1 full-extension pull-out with cushioning consisting of 2 fronts 4 adjustable baskets <i>Handle only fitted horizontally</i> <i>Grip ledges are fitted at the works to both fronts in order to achieve a continuous joint pattern.</i> <i>Runner profile top and bottom</i> <i>Baskets can be used from both sides.</i></p>  <p>Baskets: wooden shelf and metal rail</p> <p>Suitable additions:</p> <p>Hanging basket Wooden shelf with metal rail</p>		SA	30	162	P	316	330	331	333	346	349	373	-	-	-	-
		ZIK	30	P	7	7	7	7	7	7	7	-	-	-	-	-

Illustrations do not correspond to the door finishes.

Appliance housings with niche height 880 mm, Appliance housings with niche height 1025 mm, Appliance housings with niche height 1225 mm

1619 mm high

Unit without plinth, carcass depth 560 mm

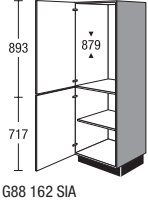
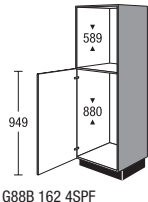
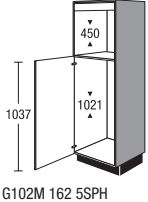
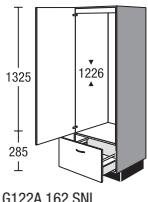
	width	Price group							Servosoft	Pro Servosoft	ProServoGlass	Soft closing Top Motion	Soft closing Top Motion Plus	
		1	2	3	4	5	6	7						
 <p>Tall unit for appliances Niche height 879 mm 1 appliance door 1 hinged door 1 adjustable shelf <i>Ventilation grills for unit ventilation are included in the delivery.</i></p> <p>G88 162 SIA</p>	G88	162	145	157	166	176	198	223	253	-	-	-	8	8
 <p>Tall unit for appliances Recess height 589 mm Niche height 880 mm 1 appliance door <i>For foil-wrapped fronts a set of heat deflector plates are supplied free of charge.</i> <i>One front panel per appliance type will be provided for adaptation on site.</i> <i>Recess sizes are adjusted in part through the use of carcass panels.</i></p> <p>G88B 162 4SPF</p>	G88B	162 4	152	162	169	177	195	217	242	-	-	-	6	6
 <p>Tall unit for appliances Niche height 450 mm niche height 1021 mm 1 fixed front panel 1 appliance door <i>One front panel per appliance type will be provided for adaptation on site.</i> <i>Niche size may be adjusted with internal infill panel or intermediate shelf</i> <i>Ventilation grills for unit ventilation are included in the delivery.</i></p> <p>G102M 162 5SPH</p>	G102M	162 5	162	173	177	183	211	233	256	-	-	-	6	6
 <p>Tall unit for appliances Niche height 1226 mm 1-2 hinged appliance doors for opening together or separately, according to finish and type of appliance 1 deep drawer <i>niche size adjustment partially with infill panels.</i> <i>For cladding up to the ceiling, provision must be made for a ventilation opening of min. 200 cm² in diameter.</i> <i>For ergonomic reasons, the hinged door for appliances is split when handle strips and recessed grips are planned.</i> <i>Front dimension bottom: 429 mm, top: 893 mm</i></p> <p>G122A 162 SNL</p>	G122A	162	167	182	193	207	237	264	299	5	8	16	8	8

4.48 Illustrations do not correspond to the door finishes.

Appliance housings with niche height 1400 mm, Appliance housings with niche height 1445 mm, Appliance housings with niche height 1580 mm

1619 mm high

Unit without plinth, carcass depth 560 mm

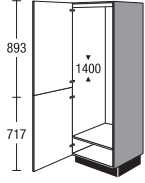
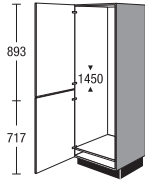
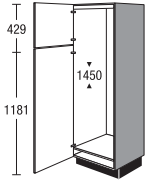
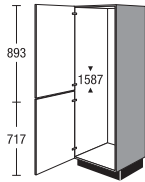
	width	Price group							Servosoft	Pro Servosoft	ProServodglass	Soft closing Top Motion	Soft closing Top Motion Plus	
		1	2	3	4	5	6	7						
 <p>Highboard for built-in appliances Niche height 1400 mm 1 hinged appliance door (pinned)</p> <p><i>Niche size may be adjusted with internal infill panel or intermediate shelf</i></p> <p><i>Ventilation grills for unit ventilation are included in the delivery.</i></p> <p><i>For cladding up to the ceiling, provision must be made for a ventilation opening of min. 200 cm² in diameter.</i></p> <p><i>Grip ledges are fitted at the works to both side-hung doors in order to achieve a continuous joint pattern.</i></p> <p>G140 162 SPA</p>	G140	162	148	161	172	183	210	235	266	-	-	-	8	8
 <p>Tall unit for appliances niche height 1450 mm 2 hinged appliance doors</p> <p><i>niche size adjustment partially with infill panels.</i></p> <p><i>Version supplied may deviate from the illustration according to appliance type.</i></p> <p><i>For cladding up to the ceiling, provision must be made for a ventilation opening of min. 200 cm² in diameter.</i></p> <p>G145 162 SPE</p>	G145	162	143	158	167	177	205	232	265	-	-	-	8	8
 <p>Tall unit for appliances niche height 1450 mm 2 hinged appliance doors</p> <p><i>niche size adjustment partially with infill panels.</i></p> <p><i>Version supplied may deviate from the illustration according to appliance type.</i></p> <p><i>For cladding up to the ceiling, provision must be made for a ventilation opening of min. 200 cm² in diameter.</i></p> <p>G145 162 8SPK</p>	G145	162 8	143	158	167	177	205	232	265	-	-	-	10	10
 <p>Tall unit for appliances Niche height 1587 mm 2 hinged appliance doors</p> <p><i>Version supplied may deviate from the illustration according to appliance type.</i></p> <p><i>For cladding up to the ceiling, provision must be made for a ventilation opening of min. 200 cm² in diameter.</i></p> <p>G158 162 SRT</p>	G158	162	149	162	173	184	211	236	267	-	-	-	8	8

Illustrations do not correspond to the door finishes.

Appliance housings with niche height 450 mm, Appliance housings with niche height 590 mm

1619 mm high

Unit without plinth, carcass depth 560 mm

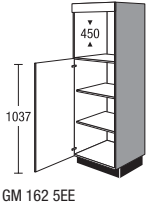
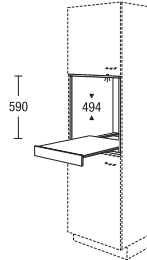
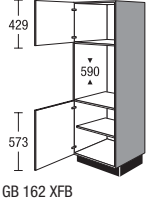
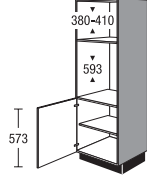
	width	Price group							Servosoft	Pro Servosoft	ProServoGlass	Soft closing Top Motion	Soft closing Top Motion Plus							
		1	2	3	4	5	6	7												
 <p>Tall unit for appliances Niche height 450 mm</p> <p>1 fixed front panel 1 hinged door 2 adjustable shelves</p> <p><i>One front panel per appliance type will be provided for adaptation on site.</i></p> <p><i>Niche size may be adjusted with internal infill panel or intermediate shelf</i></p> <p>GM 162 5EE</p>	GM	162	5						169	182	187	193	219	241	265	-	-	-	6	6
 <p>Modular built in shelf unit for highboard / tall unit for niche heights 590 mm Depth: 505 mm</p> <p>1 pull-out shelf</p> <p><i>Finish in carcass material</i></p> <p><i>Not available in visible side colours.</i></p>	MR	60	59	TA					201	201	201	201	201	201	201	-	-	-	-	-
 <p>Tall unit for appliances niche height 590 mm</p> <p>1 hinged door 1 hinged door 1 adjustable shelf</p> <p><i>For foil-wrapped fronts a set of heat deflector plates are supplied free of charge.</i></p> <p>GB 162 XFB</p>	GB	162	X						142	152	161	171	187	199	212	-	-	-	8	8
 <p>Tall unit for appliances Recess height 380 - 410 mm Niche height 593 mm</p> <p>1 hinged door 1 adjustable shelf</p> <p><i>One front panel per appliance type will be provided for adaptation on site.</i></p> <p><i>For cladding up to the ceiling, provision must be made for a ventilation opening of min. 200 cm² in diameter.</i></p> <p><i>For foil-wrapped fronts a set of heat deflector plates are supplied free of charge.</i></p> <p>GMB 162 XKC</p>	GMB	162	X						134	143	151	159	178	199	224	-	-	-	4	4

4.50 Illustrations do not correspond to the door finishes.

Appliance housings with niche height 590 mm

1619 mm high

Unit without plinth, carcass depth 560 mm

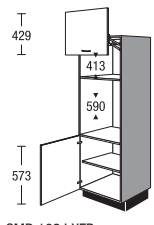
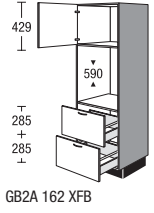
		width	Price group							Servosoft	Pro Servosoft	ProServoglass	Soft closing Top Motion	Soft closing Top Motion Plus
			1	2	3	4	5	6	7					
 <p>Tall unit for appliances with lift-up door Recess height 413 mm niche height 590 mm same as above, but plus 1 lift-up door</p> <p>Maximum size of stand-alone Height 370 mm Width 510 mm Depth: 540 mm</p> <p>430 mm opening height for lift-up door</p> <p><i>To be able to open the lift-up door, the top panel must not overhang by more than 28 mm.</i></p>	GMB	162 LX	199	213	225	238	267	299	338	-	-	-	4	4
	 <p>Highboard for built-in appliances niche height 590 mm 1 hinged door 2 deep drawers</p> <p><i>For foil-wrapped fronts a set of heat deflector plates are supplied free of charge.</i></p>	GB2A	162 X	189	244	253	263	286	302	330	10	16	32	4

Illustrations do not correspond to the door finishes.

Appliance housings with niche height 590 mm

1619 mm high

Unit without plinth, carcass depth 560 mm

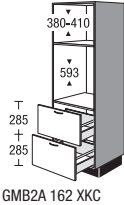
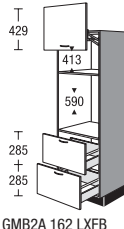
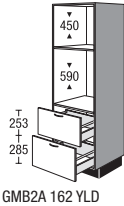
	width	Price group							Servosoft	Pro Servosoft	ProServoGlass	Soft closing Top Motion	Soft closing Top Motion Plus	
		1	2	3	4	5	6	7						
 <p>Tall unit for appliances Recess height 380 - 410 mm Niche height 593 mm 2 deep drawers</p> <p><i>One front panel per appliance type will be provided for adaptation on site.</i></p> <p><i>For cladding up to the ceiling, provision must be made for a ventilation opening of min. 200 cm² in diameter.</i></p> <p><i>For foil-wrapped fronts a set of heat deflector plates are supplied free of charge.</i></p> <p>GMB2A 162 XKC</p>	GMB2A	162 X	171	183	193	203	228	254	287	10	16	32	-	-
 <p>Tall unit for appliances with lift-up door Recess height 413 mm niche height 590 mm same as above, but plus 1 lift-up door</p> <p>Maximum size of stand-alone Height 370 mm Width 510 mm Depth: 540 mm</p> <p>430 mm opening height for lift-up door</p> <p><i>To be able to open the lift-up door, the top panel must not overhang by more than 28 mm.</i></p> <p>GMB2A 162 LXFB</p>	GMB2A	162 LX	236	253	267	281	317	354	401	10	16	32	-	-
 <p>Tall unit for appliances Niche height 450 mm niche height 590 mm 2 deep drawers</p> <p><i>One front panel per appliance type will be provided for adaptation on site.</i></p> <p><i>For foil-wrapped fronts a set of heat deflector plates are supplied free of charge.</i></p> <p>GMB2A 162 YLD</p>	GMB2A	162 Y	165	177	187	197	222	248	281	10	16	32	-	-

Tall shelf units

1619 mm high

Unit without worktop and plinth, carcass depth 560 mm. Order worktop separately.

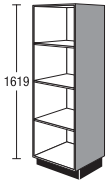
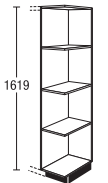
				Price group											
		width		1	2	3	4	5	6	7	Servosoft	Pro Servosoft	ProServoGlass	Soft closing Top Motion	Soft closing Top Motion Plus
	<p>Tall shelf unit</p> <p>3 adjustable shelves</p> <p><i>Finish in carcass material</i></p> <p><i>Please indicate desired width (150-600 mm).</i></p> <p><i>Not available in visible side colours.</i></p>	SR	V	162	210	210	210	210	210	210	-	-	-	-	-
	 <p>Version R</p> <p>Tall end shelf unit</p> <p>3 fixed shelves</p> <p><i>Measurements with worktop 290 mm</i> <i>Measurements with modular panel 275 mm</i></p> <p><i>Finish in carcass material</i></p> <p><i>Available in all carcass finishes.</i></p> <p><i>Additional colour variants:</i> 112 Cappuccino 121 Thyme 133 Volcano brown 134 Alby Blue 158 Sage green 952 Petrol</p> <p><i>Not available in visible side colours.</i></p>	SRA	30	162	158	158	158	158	158	158	158	-	-	-	-

Illustrations do not correspond to the door finishes.

Filler panels, Miscellaneous

1619 mm high

with neutral door division

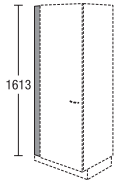
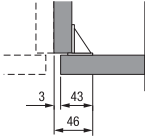
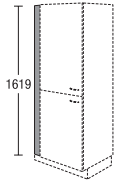
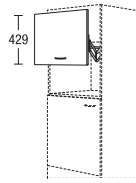
				Price group											
		width		1	2	3	4	5	6	7	ServoSoft	Pro ServoSoft	ProServoGlass	Soft closing Top Motion	Soft closing Top Motion Plus
 <p>Infill panel for tall unit without plinth, 1619 mm high</p> <p>Fitted between wall and carcass side</p> <p><i>Finish in continuous door material without edging on the wall side</i></p> <p><i>Not available in visible side colours.</i></p> <p><i>Due to the installation angle, the maximum possible on-site width reduction is 46 mm.</i></p> 	SPF	10	162 E	25	29	30	31	32	35	40	-	-	-	-	-
	SPF	20	162 E	33	37	37	38	39	47	58	-	-	-	-	-
 <p>Infill panel for highboard without plinth, 1619 mm high</p> <p><i>Finish in carcass material</i></p> <p><i>Not available in visible side colours.</i></p>	SPK	10	162	17	17	17	17	17	17	17	-	-	-	-	-
	SPK	20	162	23	23	23	23	23	23	23	-	-	-	-	-
	SPK	30	162	29	29	29	29	29	29	29	-	-	-	-	-
 <p>Lift-up door for microwave niche for retrofitting on site</p> <p>For tall units / highboards with niche height 410 mm</p> <p>Max. size of standing appliance Height: 370 mm Width: 510 mm Depth: 540 mm</p> <p><i>370 mm opening height for lift-up door</i></p>	LKP	60	43	60	63	64	66	73	79	88	-	-	-	-	-

4.54 Illustrations do not correspond to the door finishes.

Tall units 1907 mm, height 01

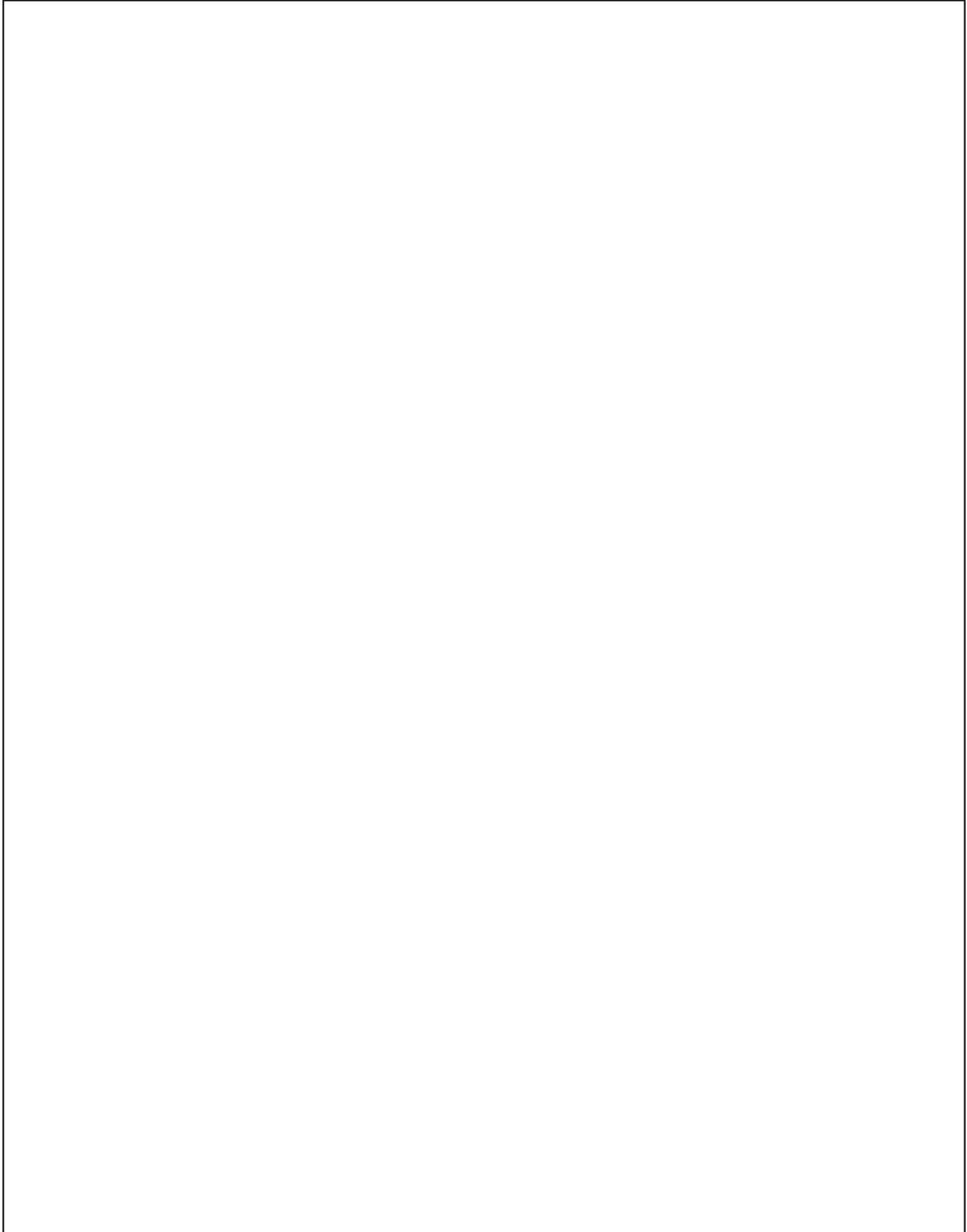

Tall units 1907 mm,
height 01

Tall units 1907 mm,
height 01



Tall units

1907 mm high

Unit without plinth, carcass depth 560 mm

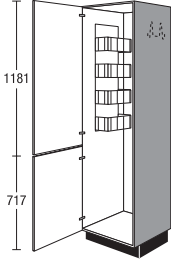
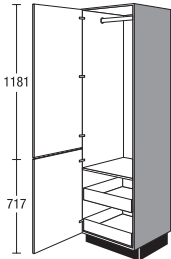
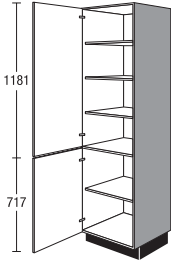
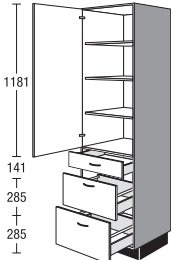
				width	Price group							Servosoft	Pro Servosoft	ProServoglass	Soft closing Top Motion	Soft closing Top Motion Plus	
					1	2	3	4	5	6	7						
 <p>Tall broom cupboard</p> <ul style="list-style-type: none"> 1 door (dowelled) 1 wire shelf 1 hook for brooms 1 universal holder for cable, hose and vacuum cleaner accessories stowage of vacuum cleaner, step ladder or ironing board possible <p><i>No wire parts if depth is reduced to less than 410 mm.</i></p> <p><i>Grip ledges are fitted at the works to both side-hung doors in order to achieve a continuous joint pattern.</i></p>	<input checked="" type="checkbox"/>	S	45	01	B	139	148	157	166	185	203	227	-	-	-	10	10
	<input checked="" type="checkbox"/>	S	50	01	B	141	152	161	170	190	208	231	-	-	-	10	10
	<input checked="" type="checkbox"/>	S	60	01	B	143	154	163	172	192	210	233	-	-	-	10	10
 <p>Tall unit</p> <ul style="list-style-type: none"> 1 door (dowelled) 1 garment rail 1 fixed shelf 2 internal drawers <p><i>The hinged doors must open to an angle of at least 90° (observe handle spacing).</i></p> <p><i>Grip ledges are fitted at the works to both side-hung doors in order to achieve a continuous joint pattern.</i></p>		S	60	01	GIS	218	224	233	242	260	277	304	10	16	16	10	10
 <p>Tall unit</p> <ul style="list-style-type: none"> 1 hinged door 3 adjustable shelves 1 hinged door 1 adjustable shelf 	<input checked="" type="checkbox"/>	S	30	01		105	115	123	131	151	168	190	-	-	-	10	10
	<input checked="" type="checkbox"/>	S	45	01		120	130	138	147	167	185	207	-	-	-	10	10
	<input checked="" type="checkbox"/>	S	50	01		134	143	152	161	180	198	222	-	-	-	10	10
	<input checked="" type="checkbox"/>	S	60	01		141	150	159	168	187	205	229	-	-	-	10	10
 <p>Tall unit</p> <ul style="list-style-type: none"> 1 hinged door 3 adjustable shelves 1 drawer 2 deep drawers 	<input checked="" type="checkbox"/>	SS2A	30	01		156	166	174	182	202	219	243	15	24	40	6	6
	<input checked="" type="checkbox"/>	SS2A	45	01		167	177	185	194	214	232	256	15	24	40	6	6
	<input checked="" type="checkbox"/>	SS2A	50	01		174	183	192	201	220	238	264	15	24	40	6	6
	<input checked="" type="checkbox"/>	SS2A	60	01		188	197	206	215	234	252	278	15	24	40	6	6

Illustrations do not correspond to the door finishes.

Tall units

1907 mm high

Unit without plinth, carcass depth 560 mm

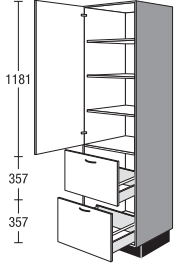
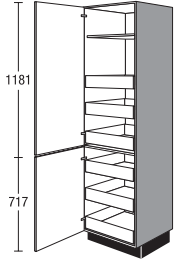
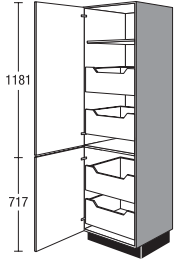
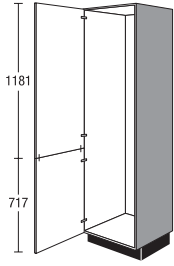
		width		Price group													
				1	2	3	4	5	6	7	Servosoft	Pro Servosoft	ProServoGlass	Soft closing Top Motion	Soft closing Top Motion Plus		
 <p>Tall unit 1 hinged door 3 adjustable shelves 2 deep drawers</p> <p><i>Unit in 300 and 450 mm widths only available for following ranges: IP 1200, IP 2200, IP 3150, IP 4050</i></p>	NEW	S2A	30	01	142	149	155	163	177	191	211	10	16	32	6	6	
	NEW	S2A	45	01	166	174	182	190	207	223	246	10	16	32	6	6	
	NEW	S2A	50	01	174	183	190	199	217	234	258	10	16	32	6	6	
		S2A	60	01	180	189	197	206	224	242	267	10	16	32	6	6	
 <p>Tall unit 1 hinged door 1 fixed shelf 3 interior drawers 1 fixed shelf 1 hinged door 3 interior drawers</p> <p><i>The hinged doors must open to an angle of at least 90° (observe handle spacing). Door must not be hinged on side adjacent to the worktop.</i></p>		S	30	01	IS	232	251	265	280	305	327	356	30	48	48	10	10
		S	45	01	IS	256	276	292	308	336	360	392	30	48	48	10	10
		S	50	01	IS	264	285	301	318	347	373	405	30	48	48	10	10
		S	60	01	IS	279	300	318	336	366	393	426	30	48	48	10	10
 <p>Tall unit 1 hinged door 1 fixed shelf 2 interior deep drawers 1 hinged door 2 interior deep drawers</p> <p><i>The hinged doors must open to an angle of at least 90° (observe handle spacing). Door must not be hinged on side adjacent to the worktop.</i></p>		S	30	01	IA	198	215	229	243	277	307	345	20	32	64	10	10
		S	45	01	IA	220	237	250	265	299	329	367	20	32	64	10	10
		S	50	01	IA	231	246	261	276	307	337	377	20	32	64	10	10
		S	60	01	IA	244	259	274	288	320	349	389	20	32	64	10	10
 <p>Tall unit for individual equipping 1 hinged door (dowelled)</p> <p><i>Grip ledges are fitted at the works to both side-hung doors in order to achieve a continuous joint pattern.</i></p>		S	60	01	Z	138	146	155	164	184	202	225	-	-	-	10	10



4.56

Illustrations do not correspond to the door finishes.

Tall units

1907 mm high

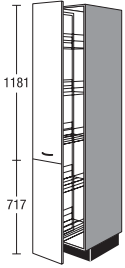
Unit without plinth, carcass depth 560 mm



			Price group													
			width	1	2	3	4	5	6	7	Servosoft	Pro Servosoft	ProServoglass	Soft closing Top Motion	Soft closing Top Motion Plus	
 <p>Pull-out tall unit with wire baskets, silver grey</p> <p>1 full-extension pull-out with cushioning consisting of 2 fronts 5 adjustable baskets</p> <p><i>Handle only fitted horizontally</i></p> <p><i>Grip ledges are fitted at the works to both fronts in order to achieve a continuous joint pattern.</i></p> 	SA	30	01	244	259	260	262	277	280	294	36	36	36	4	14	
	<p>Suitable additions:</p>															
		ZIK	30		6	6	6	6	6	6	6	-	-	-	-	-
		ZIE	30		3	3	3	3	3	3	3	-	-	-	-	-

Illustrations do not correspond to the door finishes.

Tall units

1907 mm high

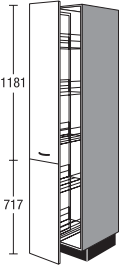
Unit without plinth, carcass depth 560 mm

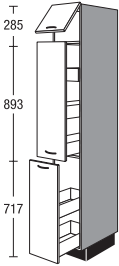
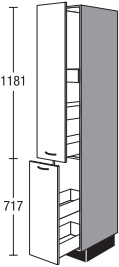
				width	Price group							Servosoft	Pro Servosoft	ProServoGlass	Soft closing Top Motion	Soft closing Top Motion Plus
					1	2	3	4	5	6	7					
 <p>Pull-out tall unit Baskets with wooden shelf and metal rail 1 full-extension pull-out with cushioning consisting of 2 fronts 5 adjustable baskets</p> <p><i>Handle only fitted horizontally</i></p> <p><i>Grip ledges are fitted at the works to both fronts in order to achieve a continuous joint pattern.</i></p> <p><i>Runner profile top and bottom Baskets can be used from both sides.</i></p> 	SA	30	01	P	346	361	362	364	379	382	400	-	-	-	-	-
	<p>Suitable additions:</p> <p>Hanging basket Wooden shelf with metal rail</p>		ZIK	30	P	7	7	7	7	7	7	7	-	-	-	-
 <p>Tall unit <input checked="" type="checkbox"/></p> 1 flap door 1 deep drawer with 2 drawers 1 internal drawer 1 deep drawer with 2 drawers <p><i>Handle only fitted horizontally</i></p> <p><i>The front panel must be removed to fit handles on ranges IP 4250, IP 7810 CK, IP 7820 CK.</i></p>	SA	30	01	KS	199	215	217	221	228	239	257	25	40	40	7	17
 <p>Tall unit <input checked="" type="checkbox"/></p> 1 deep drawer with 2 drawers 1 internal drawer 1 deep drawer with 2 drawers <p><i>Handle only fitted horizontally</i></p> <p><i>The front panel must be removed to fit handles on ranges IP 4250, IP 7810 CK, IP 7820 CK.</i></p>	SA	30	01	S	188	203	205	209	215	226	243	25	40	40	-	-

4.58

Illustrations do not correspond to the door finishes.

Tall units

1907 mm high

Unit without plinth, carcass depth 560 mm

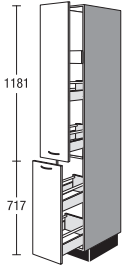
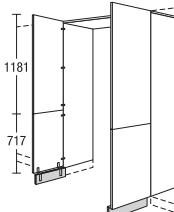
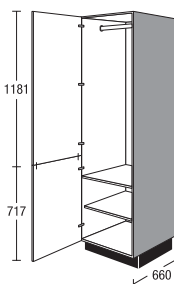
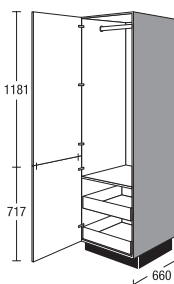

						width		Price group											
								1	2	3	4	5	6	7	Servosoft	Pro Servosoft	ProServoglass	Soft closing Top Motion	Soft closing Top Motion Plus
 <p>Tall unit</p> <p>1 Auszug mit 2 Auszügen 1 internal drawer 1 Auszug mit 2 Auszügen</p> <p><i>Handle only fitted horizontally</i></p> <p><i>The front panel must be removed to fit handles on ranges IP 4250, IP 7810 CK, IP 7820 CK.</i></p>	NEW	SA	30	01	A		200	215	217	221	227	238	255	25	40	40	-	-	
 <p>Access door</p> <p>2 doors (dowelled) 2 end panels, 16 mm thick, same colour and height as carcass 1 top panel, 16 mm thick, same colour as carcass 2 plinth panels in same colour as carcass, including connecting angle</p> <p><i>Available for the following ranges: IP 1200, IP 2200, IP 3150, IP 4050</i></p> <p><i>Not available in the following plinth decor: 299 Stainless steel effect</i></p> <p><i>Only plan between 2 tall units in height 01.</i></p> <p><i>The delivery comprises several packages.</i></p>		DG	90	01			197	210	222	-	-	-	-	-	-	-	20	20	
		DG	100	01			202	215	228	-	-	-	-	-	-	-	-	20	20
 <p>Tall unit with clothes rail</p> <p>Carcass depth 660 mm</p> <p>1 door (dowelled) 1 garment rail 1 fixed shelf 1 adjustable shelf</p> <p><i>Grip ledges are fitted at the works to both side-hung doors in order to achieve a continuous joint pattern.</i></p>	NEW	S	45	01	66G1		179	184	191	199	213	227	250	-	-	-	10	10	
	NEW	S	50	01	66G1		187	192	200	208	223	238	261	-	-	-	10	10	
	NEW	S	60	01	66G1		206	212	220	229	246	261	288	-	-	-	10	10	
 <p>Tall unit with clothes rail</p> <p>Carcass depth 660 mm</p> <p>1 door (dowelled) 1 garment rail 1 fixed shelf 2 internal drawers</p> <p><i>Grip ledges are fitted at the works to both side-hung doors in order to achieve a continuous joint pattern.</i></p>	NEW	S	45	01	66GIS		233	239	249	259	278	296	325	-	-	-	10	10	
	NEW	S	50	01	66GIS		241	248	258	268	287	306	336	-	-	-	10	10	
	NEW	S	60	01	66GIS		260	267	278	289	310	330	363	-	-	-	10	10	

Illustrations do not correspond to the door finishes.

Top box for tall unit

291 / 363 mm high

Unit without plinth, carcass depth 560 mm

		width	Price group							Servosoft	Pro Servosoft	ProServoGlass	Soft closing Top Motion	Soft closing Top Motion Plus	
			1	2	3	4	5	6	7						
 <p>Top box for tall units 291 mm high 1 flap door Handle only fitted horizontally</p> <p><i>For use in conjunction with wall units in 03 height and tall units in 01 height</i></p> <p><i>Rear panel set forward for ventilation of appliances</i></p> <p><i>Only as combination with tall units in height 01 and wall units in height 03.</i></p> <p><i>Do not plan any tall units in height 03 beside the combination of tall unit height 01 and top unit.</i></p>	AK	30	29	39	43	45	47	52	55	60	-	-	-	7	17
	AK	45	29	47	50	52	55	61	64	68	-	-	-	7	17
	AK	50	29	49	53	56	59	63	66	71	-	-	-	7	17
	AK	60	29	51	54	57	60	66	70	76	-	-	-	7	17
	AK	90	29	66	70	74	77	86	90	99	-	-	-	7	17
 <p>Top box for tall units 363 mm high 1 flap door Handle only fitted horizontally</p>	AK	60	36	65	69	73	77	84	90	97	-	-	-	7	17
	AK	90	36	80	85	90	94	104	110	120	-	-	-	7	17
	AK	100	36	86	92	97	102	113	120	131	-	-	-	9	19

Diagonal tall units

1907 mm high

Unit without plinth, carcass depth 560 mm

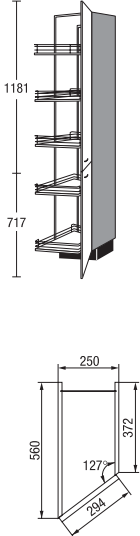
				Price group												
				width	1	2	3	4	5	6	7	Servosoft	Pro Servosoft	ProServoglass	Soft closing Top Motion	Soft closing Top Motion Plus
 <p>3-D tall unit 560/372 mm deep 1 hinged door (dowelled) 1 basket trolley with 5 adjustable baskets</p> <p><i>Grip ledges are fitted at the works to both side-hung doors in order to achieve a continuous joint pattern.</i></p> <p>Suitable additions:</p> <p>Hanging basket silver-grey</p>	SV	25	01 T	395	413	414	416	434	437	457	-	-	-	-	-	
	ZIK 25 T			11	11	11	11	11	11	11	11	-	-	-	-	

Illustrations do not correspond to the door finishes.

Appliance housings with niche height 880 mm

1907 mm high

Unit without plinth, carcass depth 560 mm

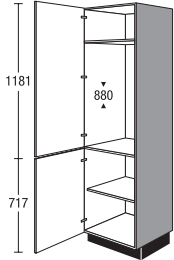
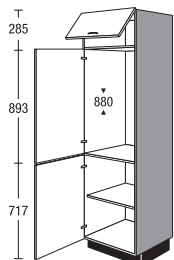
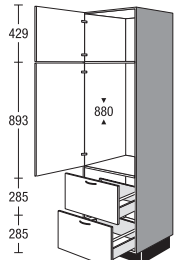
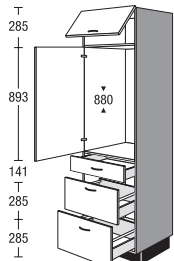
	G88	width	01	Price group							Servosoft	Pro Servosoft	ProServoGlass	Soft closing Top Motion	Soft closing Top Motion Plus
				1	2	3	4	5	6	7					
 <p>Tall unit for appliances Niche height 880 mm</p> <ul style="list-style-type: none"> 1 hinged appliance door 1 fixed shelf 1 hinged door 1 adjustable shelf <p><i>For cladding up to the ceiling, provision must be made for a ventilation opening of min. 200 cm² in diameter.</i></p> <p>G88 01 SIA</p>	G88		01	128	139	150	162	190	215	246	-	-	-	10	10
 <p>Tall unit for appliances Niche height 880 mm</p> <ul style="list-style-type: none"> 1 flap door 1 hinged appliance door 1 hinged door 1 adjustable shelf <p><i>For cladding up to the ceiling, provision must be made for a ventilation opening of min. 200 cm² in diameter.</i></p> <p>G88 01 KSIA</p>	G88		01 K	136	147	158	170	198	223	254	-	-	-	12	22
 <p>Tall unit for appliances Niche height 880 mm</p> <ul style="list-style-type: none"> 1 hinged door 1 hinged appliance door 2 deep drawers <p><i>For cladding up to the ceiling, provision must be made for a ventilation opening of min. 200 cm² in diameter.</i></p> <p>G882A 01 XSIA</p>	G882A		01 X	186	201	213	225	246	271	303	10	16	32	8	8
 <p>Tall unit for appliances Niche height 880 mm</p> <ul style="list-style-type: none"> 1 flap door 1 hinged appliance door 1 drawer 2 deep drawers <p><i>For cladding up to the ceiling, provision must be made for a ventilation opening of min. 200 cm² in diameter.</i></p> <p>G88S2A 01 KSIA</p>	G88S2A		01 K	203	214	227	241	265	292	327	15	24	40	8	18

4.62 Illustrations do not correspond to the door finishes.

Appliance housings with niche height 880 mm

1907 mm high

Unit without plinth, carcass depth 560 mm

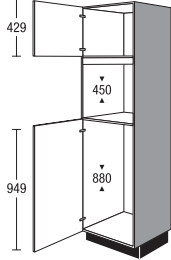
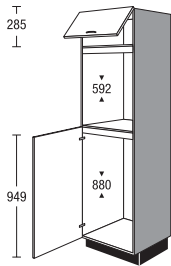
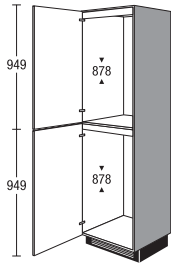
		width	Price group							Servosoft	Pro Servosoft	ProServoglass	Soft closing Top Motion	Soft closing Top Motion Plus	
			1	2	3	4	5	6	7						
 <p>Tall unit for appliances Niche height 450 mm Niche height 880 mm 1 hinged door 1 hinged appliance door <i>One front panel per appliance type will be provided for adaptation on site.</i> <i>Recess sizes are adjusted in part through the use of carcass panels.</i> <i>Version supplied may deviate from the illustration according to appliance type.</i> For cladding up to the ceiling, provision must be made for a ventilation opening of min. 200 cm² in diameter.</p> <p>G88M 01 4SOA</p>	G88M	01	4	158	168	173	178	204	225	248	-	-	-	10	10
	 <p>Tall unit for appliances Niche height 592 mm Niche height 880 mm 1 flap door 1 hinged appliance door <i>One front panel per appliance type will be provided for adaptation on site.</i> <i>Recess sizes are adjusted in part through the use of carcass panels.</i> <i>Version supplied may deviate from the illustration according to appliance type.</i> For cladding up to the ceiling, provision must be made for a ventilation opening of min. 200 cm² in diameter. For foil-wrapped fronts a set of heat deflector plates are supplied free of charge.</p> <p>G88B 01 K4 SPF</p>	G88B	01	K4	154	164	168	173	198	218	239	-	-	-	10
 <p>Tall unit for appliances Niche height 878 mm Niche height 878 mm 2 hinged appliance doors <i>niche size adjustment partially with infill panels.</i> For cladding up to the ceiling, provision must be made for a ventilation opening of min. 200 cm² in diameter.</p> <p>G8888 01 4STB</p>		G8888	01	4	132	144	153	162	180	198	221	-	-	-	12

Illustrations do not correspond to the door finishes.

Appliance housings with niche height 1025 mm, Appliance housings with niche height 1225 mm

1907 mm high

Unit without plinth, carcass depth 560 mm

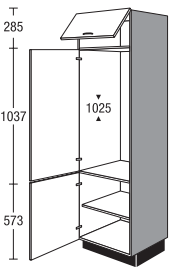
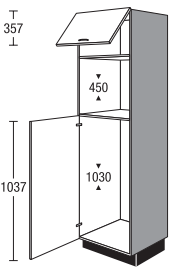
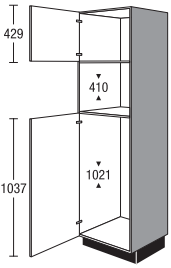
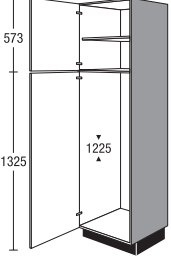
	width	Price group							Servosoft	Pro Servosoft	ProServoGlass	Soft closing Top Motion	Soft closing Top Motion Plus		
		1	2	3	4	5	6	7							
 <p>Tall unit for appliances niche height 1025 mm</p> <ul style="list-style-type: none"> 1 flap door 1 hinged appliance door 1 hinged door 1 adjustable shelf <p><i>For cladding up to the ceiling, provision must be made for a ventilation opening of min. 200 cm² in diameter.</i></p> <p>G102 01 KXSLC</p>	G102	01	KX	160	172	181	189	225	242	262	-	-	-	14	24
 <p>Tall unit for appliances Niche height 450 mm niche height 1030 mm</p> <ul style="list-style-type: none"> 1 flap door 1 appliance door 1 metal plinth base <p><i>One front panel per appliance type will be provided for adaptation on site.</i></p> <p><i>Version supplied may deviate from the illustration according to appliance type.</i></p> <p><i>For cladding up to the ceiling, provision must be made for a ventilation opening of min. 200 cm² in diameter.</i></p> <p>G102M 01 K5 SPH</p>	G102M	01	K5	175	188	200	215	228	250	275	-	-	-	10	20
 <p>Tall unit for appliances Recess height 380 - 410 mm niche height 1021 mm</p> <ul style="list-style-type: none"> 1 hinged door 1 appliance door <p><i>One front panel per appliance type will be provided for adaptation on site.</i></p> <p><i>Version supplied may deviate from the illustration according to appliance type.</i></p> <p><i>For cladding up to the ceiling, provision must be made for a ventilation opening of min. 200 cm² in diameter.</i></p> <p>G102M 01 5SPC</p>	G102M	01	5	184	196	208	222	234	255	279	-	-	-	10	10
 <p>Tall unit for appliances niche height 1225 mm</p> <ul style="list-style-type: none"> 1 hinged door 1 adjustable shelf 1 appliance door <p><i>niche size adjustment partially with infill panels.</i></p> <p><i>Version supplied may deviate from the illustration according to appliance type.</i></p> <p><i>For cladding up to the ceiling, provision must be made for a ventilation opening of min. 200 cm² in diameter.</i></p> <p>G122 01 9SNL</p>	G122	01	9	144	156	170	184	214	234	259	-	-	-	10	10

4.64 Illustrations do not correspond to the door finishes.

Appliance housings with niche height 1225 mm, Appliance housings with niche height 1400 mm, Appliance housings with niche height 1445 mm

1907 mm high

Unit without plinth, carcass depth 560 mm

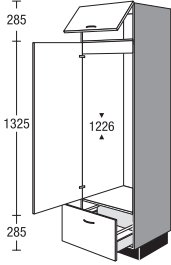
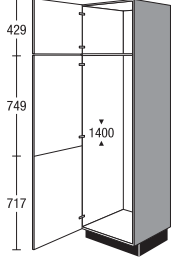
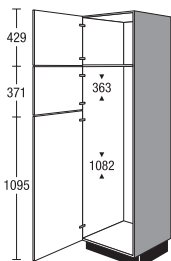
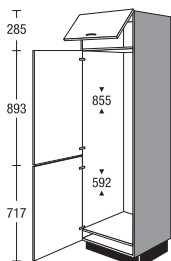
	width	Price group							Servosoft	Pro Servosoft	ProServoglass	Soft closing Top Motion	Soft closing Top Motion Plus		
		1	2	3	4	5	6	7							
 <p>Tall unit for appliances Niche height 1226 mm</p> <p>1 flap door 1 appliance door 1 deep drawer</p> <p><i>niche size adjustment partially with infill panels.</i></p> <p><i>For cladding up to the ceiling, provision must be made for a ventilation opening of min. 200 cm² in diameter.</i></p> <p><i>For ergonomic reasons, the hinged door for appliances is split when handle strips and recessed grips are planned.</i> <i>Front dimension bottom: 429 mm, top: 893 mm</i></p> <p>G122A 01 KSNL</p>	G122A	01	K	176	191	204	218	248	266	291	5	8	16	13	27
 <p>Tall unit for appliances Niche height 1400 mm</p> <p>1 hinged door 1 hinged appliance door (pinned)</p> <p><i>niche size adjustment partially with infill panels.</i></p> <p><i>Version supplied may deviate from the illustration according to appliance type.</i></p> <p><i>For cladding up to the ceiling, provision must be made for a ventilation opening of min. 200 cm² in diameter.</i></p> <p><i>Grip ledges are fitted to both appliance side-hung doors at the works in order to achieve a continuous joint pattern.</i></p> <p>G140 01 SPA</p>	G140	01		145	157	171	185	216	235	262	-	-	-	12	12
 <p>Tall unit for appliances Recess height 363 mm Recess height 1082 mm</p> <p>1 hinged door 2 hinged appliance doors</p> <p><i>niche size adjustment partially with infill panels.</i></p> <p><i>Version supplied may deviate from the illustration according to appliance type.</i></p> <p><i>For cladding up to the ceiling, provision must be made for a ventilation opening of min. 200 cm² in diameter.</i></p> <p>G145 01 6SPK</p>	G145	01	6	141	153	166	180	210	229	254	-	-	-	14	14
 <p>Tall unit for appliances Recess height 855 mm Niche height 592 mm</p> <p>1 flap door 2 hinged appliance doors</p> <p><i>niche size adjustment partially with infill panels.</i></p> <p><i>Version supplied may deviate from the illustration according to appliance type.</i></p> <p><i>For cladding up to the ceiling, provision must be made for a ventilation opening of min. 200 cm² in diameter.</i></p> <p>G145 01 KSPE</p>	G145	01	K	152	164	179	193	225	245	272	-	-	-	12	22

Illustrations do not correspond to the door finishes.

4.65

Appliance housings with niche height 1445 mm, Appliance housings with niche height 1580 mm

1907 mm high

Unit without plinth, carcass depth 560 mm

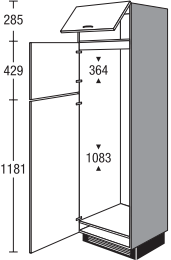
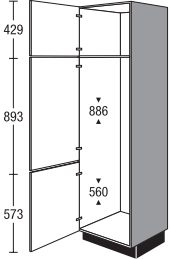
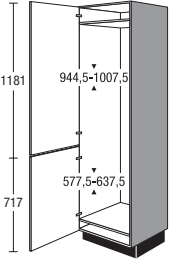
	width	Price group							Servosoft	Pro Servosoft	ProServoGlass	Soft closing Top Motion	Soft closing Top Motion Plus		
		1	2	3	4	5	6	7							
 <p>Tall unit for appliances niche height 1450 mm</p> <p>1 flap door 2 hinged appliance doors</p> <p><i>niche size adjustment partially with infill panels.</i></p> <p><i>Version supplied may deviate from the illustration according to appliance type.</i></p> <p><i>For cladding up to the ceiling, provision must be made for a ventilation opening of min. 200 cm² in diameter.</i></p> <p>G145 01 K8SPK</p>	G145	01	K8	152	164	177	191	221	240	266	-	-	-	14	24
 <p>Tall unit for appliances Recess height 886 mm Recess height 560 mm</p> <p>1 hinged door 2 hinged appliance doors</p> <p><i>niche size adjustment partially with infill panels.</i></p> <p><i>Version supplied may deviate from the illustration according to appliance type.</i></p> <p><i>For cladding up to the ceiling, provision must be made for a ventilation opening of min. 200 cm² in diameter.</i></p> <p>G145 01 XSPM</p>	G145	01	X	140	152	165	179	208	227	252	-	-	-	12	12
 <p>Tall unit for appliances Recess height 944.5 - 1007.5 mm Recess height 577.5 - 637.5 mm</p> <p>2 hinged appliance doors</p> <p><i>niche size adjustment partially with infill panels.</i></p> <p><i>Version supplied may deviate from the illustration according to appliance type.</i></p> <p><i>For cladding up to the ceiling, provision must be made for a ventilation opening of min. 200 cm² in diameter.</i></p> <p>G158 01 SRL</p>	G158	01		140	152	165	179	208	227	252	-	-	-	10	10

4.66 Illustrations do not correspond to the door finishes.

Appliance housings with niche height 1580 mm, Appliance housings with niche height 1780 mm, Appliance housings with aperture height 1890 mm

1907 mm high

Unit without plinth, carcass depth 560 mm

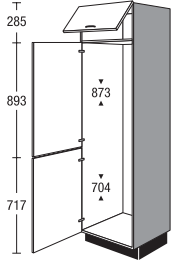
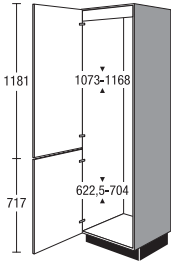
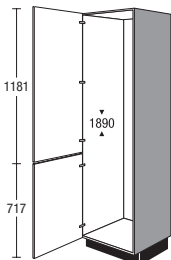
	width	Price group							Servosoft	Pro Servosoft	ProServoglass	Soft closing Top Motion	Soft closing Top Motion Plus		
		1	2	3	4	5	6	7							
 <p>Tall unit for appliances Recess height 873 mm niche height 704 mm</p> <p>1 flap door 2 hinged appliance doors for opening together or separately, according to finish and type of appliance</p> <p><i>niche size adjustment partially with infill panels.</i></p> <p><i>Version supplied may deviate from the illustration according to appliance type.</i></p> <p><i>Grip ledges are fitted at the works to both appliance doors that open together in order to achieve a continuous joint pattern.</i></p> <p><i>For cladding up to the ceiling, provision must be made for a ventilation opening of min. 200 cm² in diameter.</i></p> <p>G158 01 KSRT</p>	G158	01	K	149	161	175	190	220	240	266	-	-	-	12	22
 <p>Tall unit for appliances Recess height 1073 - 1168 mm Recess height 622.5 - 704 mm</p> <p>2 hinged appliance doors for opening together or separately, according to finish and type of appliance</p> <p><i>niche size adjustment partially with infill panels.</i></p> <p><i>Version supplied may deviate from the illustration according to appliance type.</i></p> <p><i>Grip ledges are fitted at the works to both appliance doors that open together in order to achieve a continuous joint pattern.</i></p> <p><i>For cladding up to the ceiling, provision must be made for a ventilation opening of min. 200 cm² in diameter.</i></p> <p>G178 01 STD</p>	G178	01		141	156	164	174	201	227	257	-	-	-	10	10
 <p>Tall unit for appliances Recess height 1890 mm</p> <p>2 hinged appliance doors</p> <p><i>niche size adjustment partially with infill panels.</i></p> <p><i>Version supplied may deviate from the illustration according to appliance type.</i></p> <p><i>For cladding up to the ceiling, provision must be made for a ventilation opening of min. 200 cm² in diameter.</i></p> <p>G189 01 SUH</p>	G189	01		163	180	190	201	232	262	297	-	-	-	10	10

Illustrations do not correspond to the door finishes.

Appliance housings with niche height 380 mm, Appliance housings with niche height 450 mm

1907 mm high

Unit without plinth, carcass depth 560 mm

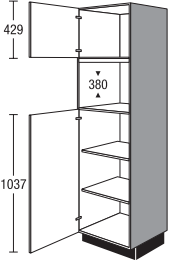
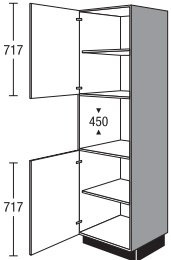
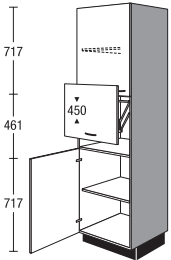
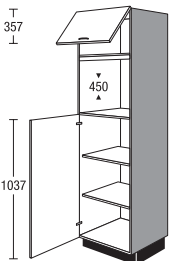
	width	Price group							Servosoft	Pro Servosoft	ProServoGlass	Soft closing Top Motion	Soft closing Top Motion Plus		
		1	2	3	4	5	6	7							
 <p>Tall unit for appliances niche height 380 mm</p> <p>1 hinged door 1 hinged door 2 adjustable shelves</p> <p><i>One front panel per appliance type will be provided for adaptation on site.</i></p> <p><i>Recess sizes are adjusted in part through the use of carcass panels.</i></p> <p><i>For cladding up to the ceiling, provision must be made for a ventilation opening of min. 200 cm² in diameter.</i></p> <p>GM 01 5DF</p>	GM	01	5	157	168	178	190	201	219	241	-	-	-	10	10
 <p>Tall unit for appliances Niche height 450 mm</p> <p>1 hinged door 1 adjustable shelf (depending on finish) 1 hinged door 1 adjustable shelf</p> <p><i>For cladding up to the ceiling, provision must be made for a ventilation opening of min. 200 cm² in diameter.</i></p> <p>GM 01 EE</p>	GM	01		146	156	165	175	191	202	216	-	-	-	8	8
 <p>Tall unit for appliances with lift-up door Niche height 450 mm</p> <p>same as above, but plus 1 lift-up door</p> <p>Maximum size of stand-alone Height 400 mm Width 510 mm Depth: 540</p> <p>430 mm opening height for lift-up door</p> <p>GM 01 L</p>	GM	01	L	211	226	239	254	278	295	316	-	-	-	8	8
 <p>Tall unit for appliances Niche height 450 mm</p> <p>1 flap door 1 hinged door 2 adjustable shelves</p> <p><i>One front panel per appliance type will be provided for adaptation on site.</i></p> <p><i>Recess sizes are adjusted in part through the use of carcass panels.</i></p> <p><i>For cladding up to the ceiling, provision must be made for a ventilation opening of min. 200 cm² in diameter.</i></p> <p>GM 01 K5EE</p>	GM	01	K5	179	193	205	217	229	250	275	-	-	-	10	20

4.68

Illustrations do not correspond to the door finishes.

Appliance housings with niche height 450 mm, Appliance housings with niche height 590 mm

1907 mm high

Unit without plinth, carcass depth 560 mm

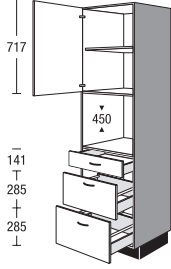
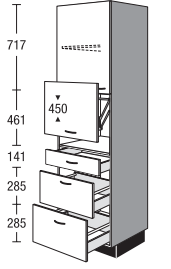
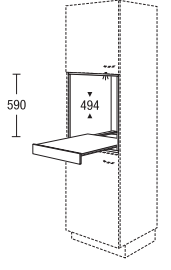
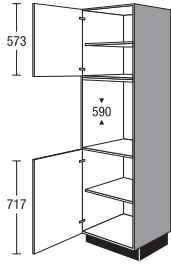
		Price group												
		width								Servosoft	Pro Servosoft	ProServoglass	Soft closing Top Motion	Soft closing Top Motion Plus
			1	2	3	4	5	6	7					
 <p>Tall unit for appliances Niche height 450 mm 1 hinged door 1 adjustable shelf 1 drawer 2 deep drawers</p> <p><i>For cladding up to the ceiling, provision must be made for a ventilation opening of min. 200 cm² in diameter.</i></p> <p>GMS2A 01 EE</p>	GMS2A	01	209	225	240	253	277	304	333	15	24	40	4	4
	 <p>Tall unit for appliances with lift-up door Niche height 450 mm same as above, but plus 1 lift-up door</p> <p>Maximum size of stand-alone Height 400 mm Width 510 mm Depth: 540</p> <p>430 mm opening height for lift-up door</p> <p>GMS2A 01 L</p>	GMS2A	01 L	279	300	320	338	370	406	445	15	24	40	4
 <p>Modular built in shelf unit for highboard / tall unit for niche heights 590 mm Depth: 505 mm</p> <p>1 pull-out shelf</p> <p><i>Finish in carcass material</i></p> <p><i>Not available in visible side colours.</i></p> <p>MR</p>	MR	60 59 TA	201	201	201	201	201	201	201	-	-	-	-	-
 <p>Tall unit for appliances niche height 590 mm 1 hinged door 1 adjustable shelf 1 hinged door 1 adjustable shelf</p> <p><i>For cladding up to the ceiling, provision must be made for a ventilation opening of min. 200 cm² in diameter.</i></p> <p><i>For foil-wrapped fronts a set of heat deflector plates are supplied free of charge.</i></p> <p>GB 01 FB</p>	GB	01	131	139	147	155	169	178	190	-	-	-	8	8

Illustrations do not correspond to the door finishes.

Appliance housings with niche height 590 mm

1907 mm high

Unit without plinth, carcass depth 560 mm

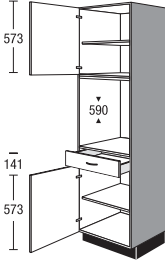
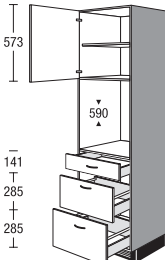
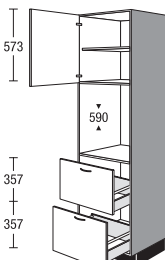
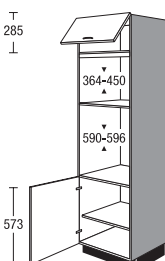
	width	Price group							Servosoft	Pro Servosoft	ProServoGlass	Soft closing Top Motion	Soft closing Top Motion Plus	
		1	2	3	4	5	6	7						
 <p>Tall unit for appliances niche height 590 mm</p> <p>1 hinged door 1 adjustable shelf 1 drawer 1 hinged door 1 adjustable shelf</p> <p><i>For cladding up to the ceiling, provision must be made for a ventilation opening of min. 200 cm² in diameter.</i></p> <p><i>For foil-wrapped fronts a set of heat deflector plates are supplied free of charge.</i></p> <p>GBS 01 FB</p>	GBS	01	148	159	167	176	191	201	215	5	8	8	8	8
 <p>Tall unit for appliances niche height 590 mm</p> <p>1 hinged door 1 adjustable shelf 1 drawer 2 deep drawers</p> <p><i>For cladding up to the ceiling, provision must be made for a ventilation opening of min. 200 cm² in diameter.</i></p> <p><i>For foil-wrapped fronts a set of heat deflector plates are supplied free of charge.</i></p> <p>GBS2A 01 FB</p>	GBS2A	01	201	216	230	243	266	292	320	15	24	40	4	4
 <p>Tall unit for appliances niche height 590 mm</p> <p>1 hinged door 1 adjustable shelf 2 deep drawers</p> <p><i>For cladding up to the ceiling, provision must be made for a ventilation opening of min. 200 cm² in diameter.</i></p> <p><i>For foil-wrapped fronts a set of heat deflector plates are supplied free of charge.</i></p> <p>GB2A 01 FB</p>	GB2A	01	189	203	217	229	251	275	302	10	16	32	4	4
 <p>Tall unit for appliances</p> <p>Recess height 364 - 450 mm</p> <p>Recess height 590 - 596 mm</p> <p>1 flap door 1 hinged door 1 adjustable shelf</p> <p><i>One front panel per appliance type will be provided for adaptation on site.</i></p> <p><i>For cladding up to the ceiling, provision must be made for a ventilation opening of min. 200 cm² in diameter.</i></p> <p><i>For foil-wrapped fronts a set of heat deflector plates are supplied free of charge.</i></p> <p>GMB 01 KXLA</p>	GMB	01 KX	149	167	175	183	192	211	232	-	-	-	8	18

4.70 Illustrations do not correspond to the door finishes.

Appliance housings with niche height 590 mm

1907 mm high

Unit without plinth, carcass depth 560 mm

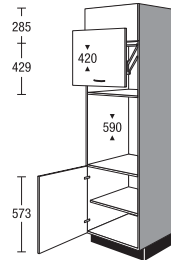
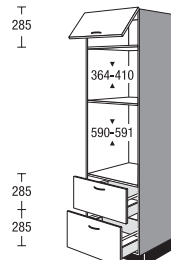
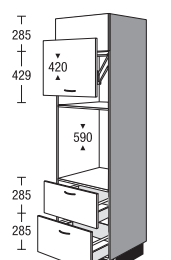
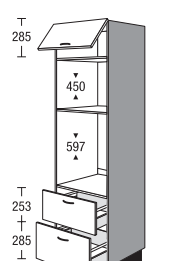
				Price group												
				width	1	2	3	4	5	6	7	Servosoft	Pro Servosoft	ProServoglass	Soft closing Top Motion	Soft closing Top Motion Plus
 <p>Tall unit for appliances with lift-up door Recess height 420 mm niche height 590 mm same as above, but plus 1 lift-up door</p> <p>Maximum size of stand-alone Height 370 mm Width 510 mm Depth: 540 mm</p> <p>430 mm opening height for lift-up door</p> <p>GMB 01 KLXFB</p>	GMB	01	KLX		214	241	253	265	278	307	338	-	-	-	8	18
	 <p>Tall unit for appliances Recess height 364 - 410 mm Recess height 590 - 591 mm 1 flap door 2 deep drawers</p> <p><i>One front panel per appliance type will be provided for adaptation on site.</i></p> <p><i>For cladding up to the ceiling, provision must be made for a ventilation opening of min. 200 cm² in diameter.</i></p> <p><i>For foil-wrapped fronts a set of heat deflector plates are supplied free of charge.</i></p> <p>GMB2A 01 KXLA</p>	GMB2A	01	KX	195	210	222	234	257	280	307	10	16	32	4	14
 <p>Tall unit for appliances with lift-up door Recess height 420 mm niche height 590 mm same as above, but plus 1 lift-up door</p> <p>Maximum size of stand-alone Height 370 mm Width 510 mm Depth: 540 mm</p> <p>430 mm opening height for lift-up door</p> <p>GMB2A 01 KLXFB</p>		GMB2A	01	KLX	260	281	297	314	345	377	414	10	16	32	4	14
	 <p>Tall unit for appliances Niche height 450 mm Niche height 597 mm 1 flap door 2 deep drawers</p> <p><i>One front panel per appliance type will be provided for adaptation on site.</i></p> <p><i>For cladding up to the ceiling, provision must be made for a ventilation opening of min. 200 cm² in diameter.</i></p> <p><i>For foil-wrapped fronts a set of heat deflector plates are supplied free of charge.</i></p> <p>GMB2A 01 KYLD</p>	GMB2A	01	KY	202	217	231	244	268	293	321	10	16	32	4	14

Illustrations do not correspond to the door finishes.

Appliance housings with niche height 590 mm

1907 mm high

Unit without plinth, carcass depth 560 mm

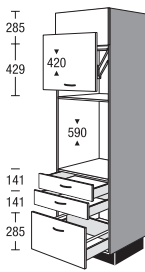
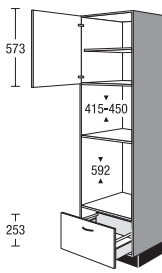
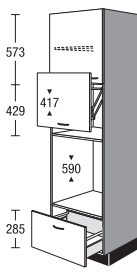
	width	Price group							Servosoft	Pro Servosoft	ProServoGlass	Soft closing Top Motion	Soft closing Top Motion Plus		
		1	2	3	4	5	6	7							
 <p>Tall unit for appliances with lift-up door Recess height 420 mm niche height 590 mm same as above, but plus 1 lift-up door</p> <p>Maximum size of stand-alone Height 340 mm Width 510 mm Depth: 540 mm</p> <p>430 mm opening height for lift-up door</p> <p><i>For cladding up to the ceiling, provision must be made for a ventilation opening of min. 200 cm² in diameter.</i></p> <p><i>For foil-wrapped fronts a set of heat deflector plates are supplied free of charge.</i></p>	GMB2SA	01	KLX	261	279	294	310	337	367	401	15	24	32	4	14
 <p>Tall unit for appliances Recess height 415 - 450 mm Niche height 592 mm 1 hinged door 1 adjustable shelf 1 deep drawer</p> <p><i>One front panel per appliance type will be provided for adaptation on site.</i></p> <p><i>Recess sizes are adjusted in part through the use of carcass panels.</i></p> <p><i>Version supplied may deviate from the illustration according to appliance type.</i></p> <p><i>For foil-wrapped fronts a set of heat deflector plates are supplied free of charge.</i></p>	GMBA	01		151	160	169	177	193	209	228	5	8	16	4	4
 <p>Tall unit for appliances with lift-up door Recess height 417 mm niche height 590 mm same as above, but plus 1 lift-up door</p> <p>Maximum size of stand-alone Height 370 mm Width 510 mm Depth: 540 mm</p> <p>430 mm opening height for lift-up door</p>	GMBA	01	L	221	234	247	259	282	306	334	5	8	16	4	4

4.72 Illustrations do not correspond to the door finishes.

Tall shelf units

1907 mm high

Unit without plinth, carcass depth 560 mm

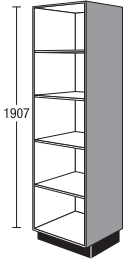
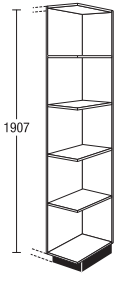
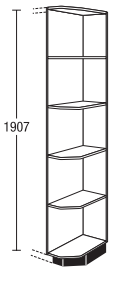
				width	Price group							Servosoft	Pro Servosoft	ProServoglass	Soft closing Top Motion	Soft closing Top Motion Plus		
					1	2	3	4	5	6	7							
 <p>1907</p>	<p>Tall shelf unit</p> <p>4 adjustable shelves</p> <p><i>Finish in carcass material</i></p> <p><i>Please indicate desired width (150-600 mm).</i></p> <p><i>Not available in visible side colours.</i></p>	☑	SR	V	01	222	222	222	222	222	222	222	-	-	-	-	-	
	 <p>1907</p> <p>Version R</p>	<p>Tall end shelf unit</p> <p>4 fixed shelves</p> <p><i>Measurements with worktop 290 mm</i></p> <p><i>Measurements with modular panel 275 mm</i></p> <p><i>Finish in carcass material</i></p> <p><i>Available in all carcass finishes.</i></p> <p><i>Additional colour variants:</i></p> <p>112 Cappuccino</p> <p>121 Thyme</p> <p>133 Volcano brown</p> <p>134 Alby Blue</p> <p>158 Sage green</p> <p>952 Petrol</p> <p><i>Not available in visible side colours.</i></p>		SRA	30	01	161	161	161	161	161	161	161	-	-	-	-	-
		 <p>1907</p> <p>Version R</p>	<p>Tall end shelf unit angled</p> <p>4 fixed shelves</p> <p><i>Finish in carcass material</i></p> <p><i>Not available in visible side colours.</i></p>		SRA	25	01	S	149	149	149	149	149	149	149	-	-	-

Illustrations do not correspond to the door finishes.

Filler panels, Miscellaneous

1907 mm high

with neutral door division

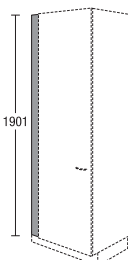
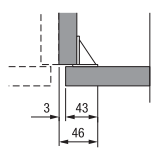
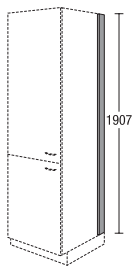
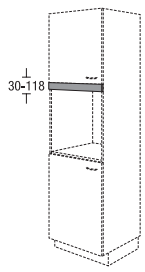
		width	Price group							Servosoft	Pro Servosoft	ProServoGlass	Soft closing Top Motion	Soft closing Top Motion Plus	
			1	2	3	4	5	6	7						
 <p>Infill panel for tall unit without plinth, 1907 mm high Fitted between wall and carcass side</p> <p><i>Finish in continuous door material without edging on the wall side</i></p> <p><i>Not available in visible side colours.</i></p> <p><i>Due to the installation angle, the maximum possible on-site width reduction is 46 mm.</i></p>	SPF	10	01	E	26	29	31	32	34	36	40	-	-	-	-
	SPF	20	01	E	34	37	39	41	48	52	58	-	-	-	-
 <p>Infill panel for tall unit without plinth, 1907 mm high</p> <p><i>Finish in carcass material</i></p> <p><i>Not available in visible side colours.</i></p>	SPK	10	01		18	18	18	18	18	18	18	-	-	-	-
	SPK	20	01		22	22	22	22	22	22	22	-	-	-	-
	SPK	30	01		27	27	27	27	27	27	27	-	-	-	-
 <p>Infill panel for tall-unit side for wall join etc.</p> <p>without plinth, 1907 mm high</p> <p><i>Finish in carcass material</i></p> <p><i>for deeper units, order plinth SO 151 separately</i></p> <p><i>Not available in visible side colours.</i></p>	SPT	10	01		18	18	18	18	18	18	18	-	-	-	-
	SPT	20	01		21	21	21	21	21	21	21	-	-	-	-
	SPT	30	01		24	24	24	24	24	24	24	-	-	-	-
 <p>Door material infill panel for appliance housing units</p> <p>For covering the carcass inner panel with edge protection stainless steel coloured</p> <p>Height 30-118 mm</p> <p><i>Please state the desired height.</i></p>	FBG	60		G	25	29	30	31	33	35	40	-	-	-	-

Filler panels, Miscellaneous

1907 mm high

with neutral door division

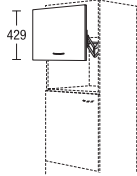
				Price group													
				width	1	2	3	4	5	6	7	Servosoft	Pro Servosoft	ProServoglass	Soft closing Top Motion	Soft closing Top Motion Plus	
<p>Door material infill panel for appliance housing units</p> <p>For covering the carcass inner panel with edge protection stainless steel coloured</p> <p>Height 118 mm for on-site adaptation</p>				FBG	60	Z							-	-	-	-	-
 <p>Lift-up door for microwave niche for retrofitting on site</p> <p>For tall units / highboards with niche height 410 mm</p> <p>Max. size of standing appliance Height: 370 mm Width: 510 mm Depth: 540 mm</p> <p><i>370 mm opening height for lift-up door</i></p>				LKP	60	43							-	-	-	-	-

Illustrations do not correspond to the door finishes.

Notes

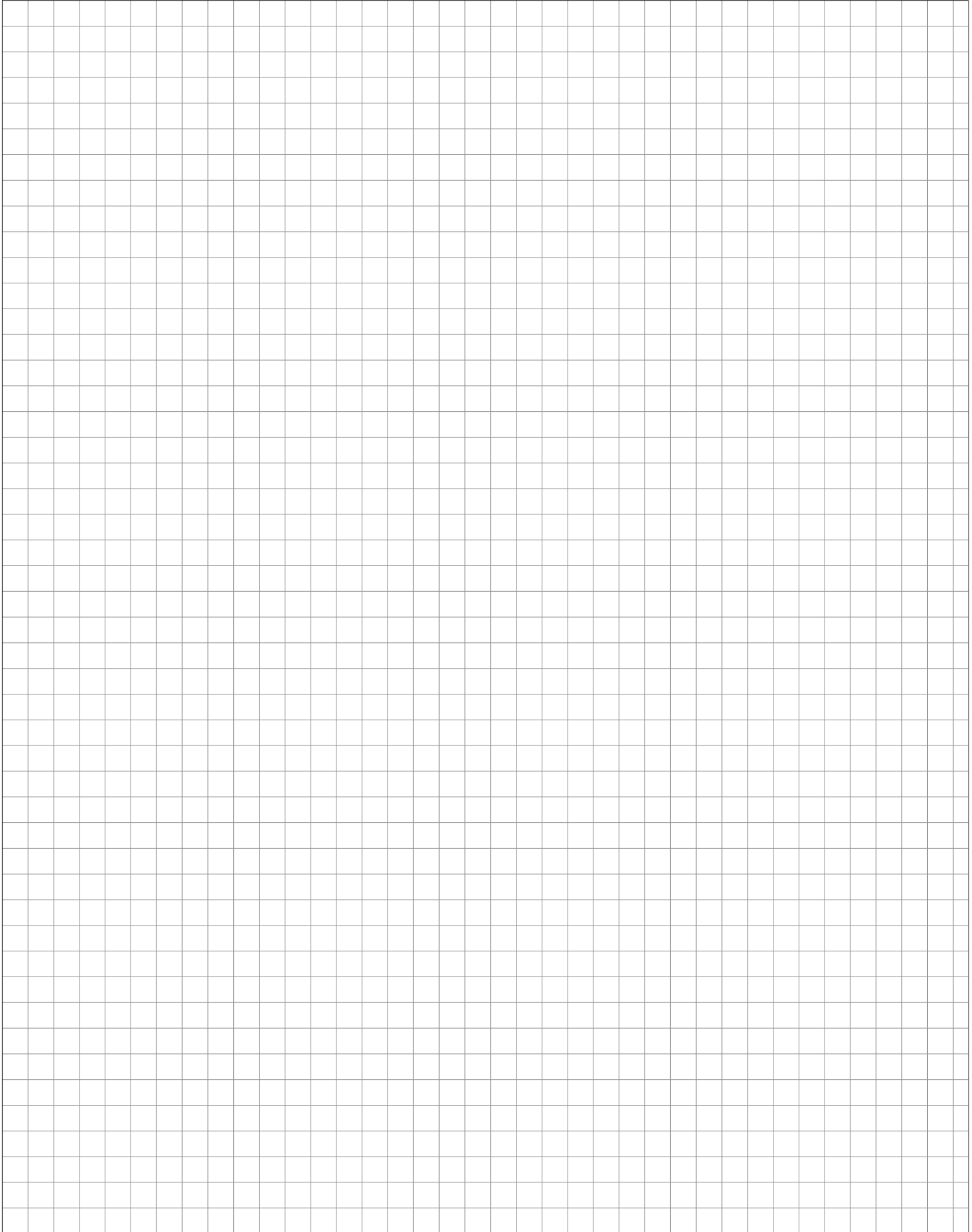

Tall units 2051 mm, height 02

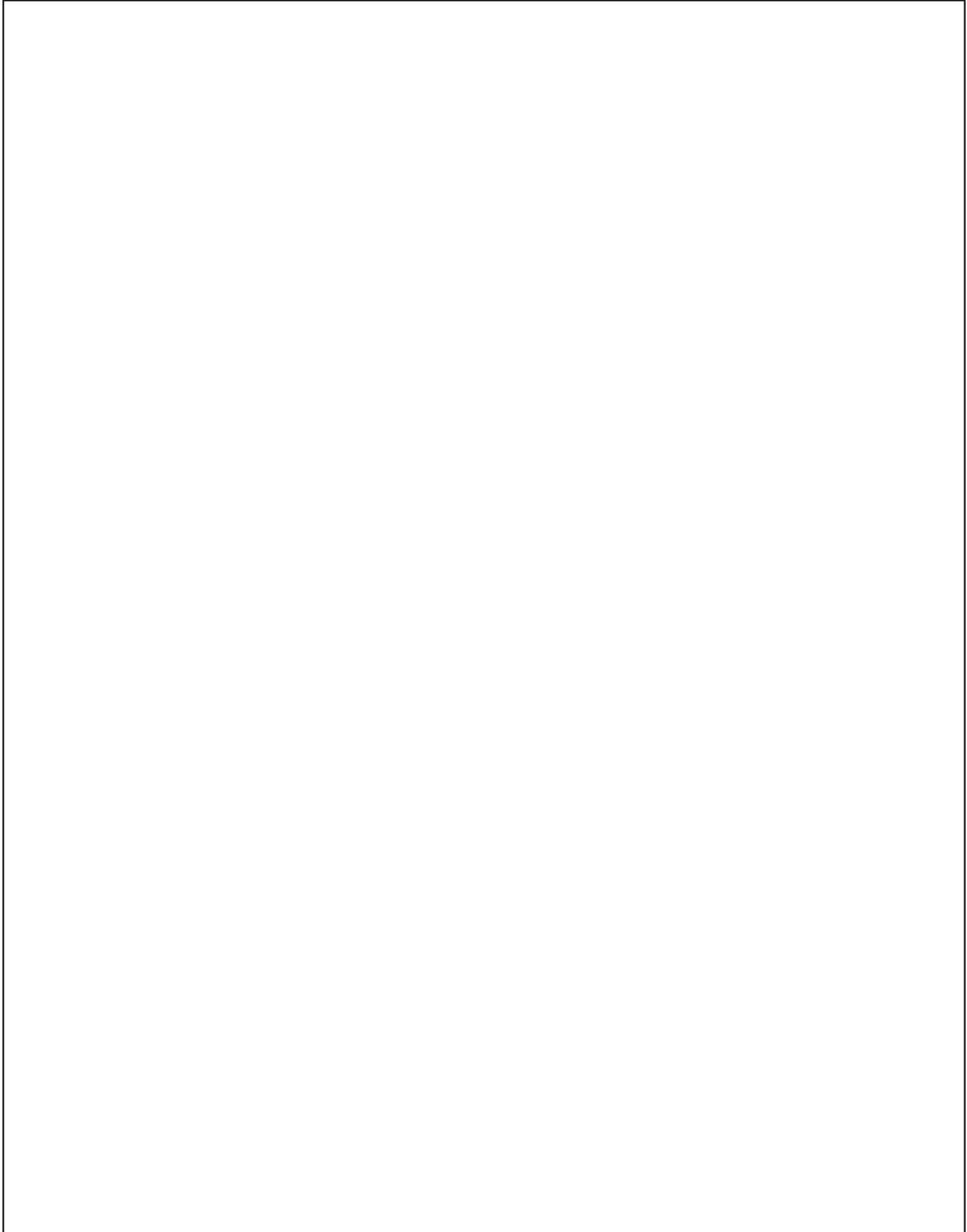

Tall units 2051 mm,
height 02

Tall units 2051 mm,
height 02



Tall units

2051 mm high

Unit without plinth, carcass depth 560 mm

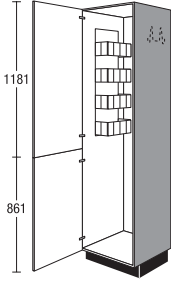
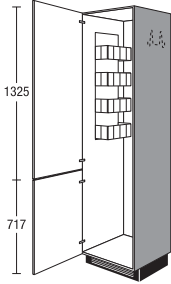
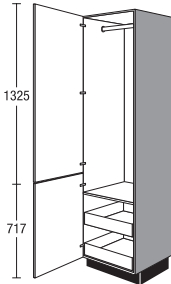
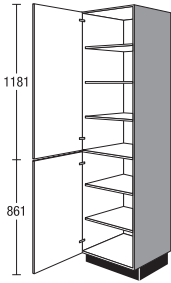
				width	Price group							Servosoft	Pro Servosoft	ProServoglass	Soft closing Top Motion	Soft closing Top Motion Plus		
					1	2	3	4	5	6	7							
	Tall broom cupboard		S	45	02	B2	142	154	164	174	197	217	242	-	-	-	10	10
	1 door (dowelled)		S	50	02	B2	146	159	170	181	203	223	248	-	-	-	10	10
	1 wire shelf		S	60	02	B2	156	169	179	190	214	234	260	-	-	-	10	10
<p>1 hook for brooms</p> <p>1 universal holder for cable, hose and vacuum cleaner accessories</p> <p>stowage of vacuum cleaner, step ladder or ironing board possible</p> <p><i>No wire parts if depth is reduced to less than 410 mm.</i></p> <p><i>Grip ledges are fitted at the works to both side-hung doors in order to achieve a continuous joint pattern.</i></p>																		
	Tall broom cupboard		S	60	02	B	156	169	179	190	214	234	260	-	-	-	10	10
	1 door (dowelled)																	
<p>1 wire shelf</p> <p>1 hook for brooms</p> <p>1 universal holder for cable, hose and vacuum cleaner accessories</p> <p>stowage of vacuum cleaner, step ladder or ironing board possible</p> <p><i>No wire parts if depth is reduced to less than 410 mm.</i></p> <p><i>Grip ledges are fitted at the works to both side-hung doors in order to achieve a continuous joint pattern.</i></p>																		
	Tall unit		S	60	02	GIS	231	240	249	260	282	302	329	10	16	16	10	10
	1 door (dowelled)																	
<p>1 garment rail</p> <p>1 fixed shelf</p> <p>2 internal drawers</p> <p><i>The hinged doors must open to an angle of at least 90° (observe handle spacing).</i></p> <p><i>Grip ledges are fitted at the works to both side-hung doors in order to achieve a continuous joint pattern.</i></p>																		
	Tall unit		S	30	02	2	118	128	136	144	164	181	203	-	-	-	10	10
	1 hinged door		S	45	02	2	138	150	158	167	194	214	239	-	-	-	10	10
	3 adjustable shelves		S	50	02	2	146	157	165	174	200	220	246	-	-	-	10	10
	1 hinged door		S	60	02	2	155	167	177	188	211	231	256	-	-	-	10	10
<p>2 adjustable shelves</p>																		

Illustrations do not correspond to the door finishes.

Tall units

2051 mm high

Unit without plinth, carcass depth 560 mm

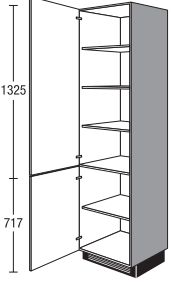
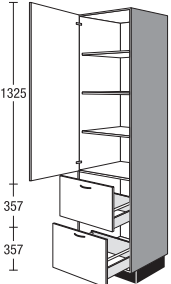
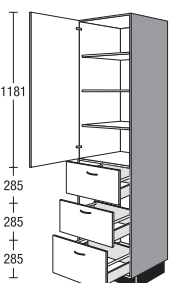
				width	Price group							Servosoft	Pro Servosoft	ProServoGlass	Soft closing Top Motion	Soft closing Top Motion Plus	
					1	2	3	4	5	6	7						
 <p>Tall unit 1 hinged door 3 adjustable shelves 1 hinged door 1 adjustable shelf</p>	<input checked="" type="checkbox"/>	S	30	02	117	127	135	143	163	179	201	-	-	-	10	10	
	<input checked="" type="checkbox"/>	S	60	02	154	166	176	187	209	229	254	-	-	-	10	10	
<p>Tall unit as above</p> <p><i>Available for the following ranges: IP 1200, IP 2200, IP 3150, IP 4050</i></p>	<input checked="" type="checkbox"/>	S	45	02	142	154	161	172	189	205	226	-	-	-	10	10	
	<input checked="" type="checkbox"/>	S	50	02	146	158	165	177	194	211	232	-	-	-	10	10	
 <p>Tall unit 1 hinged door 3 adjustable shelves 2 deep drawers</p>	<input checked="" type="checkbox"/>	S2A	30	02	145	154	161	169	186	201	220	10	16	32	6	6	
	<input checked="" type="checkbox"/>	S2A	60	02	193	205	214	225	247	267	293	10	16	32	6	6	
<p>Tall unit as above</p> <p><i>Available for the following ranges: IP 1200, IP 2200, IP 3150, IP 4050</i></p>	<input checked="" type="checkbox"/>	S2A	45	02	169	180	187	197	216	234	257	10	16	32	6	6	
	<input checked="" type="checkbox"/>	S2A	50	02	178	189	197	208	228	246	270	10	16	32	6	6	
 <p>Tall unit 1 hinged door 3 adjustable shelves 3 deep drawers</p>	<input checked="" type="checkbox"/>	S3A	30	02	X	160	170	178	186	206	223	247	15	24	48	6	6
	<input checked="" type="checkbox"/>	S3A	45	02	X	176	188	196	205	232	252	278	15	24	48	6	6
	<input checked="" type="checkbox"/>	S3A	50	02	X	184	195	203	212	238	258	285	15	24	48	6	6
	<input checked="" type="checkbox"/>	S3A	60	02	X	199	211	221	232	255	275	302	15	24	48	6	6

4.78 Illustrations do not correspond to the door finishes.

Tall units

2051 mm high

Unit without plinth, carcass depth 560 mm



						Price group												
				width		1	2	3	4	5	6	7	Servosoft	Pro Servosoft	ProServodiamond	Soft closing Top Motion	Soft closing Top Motion Plus	
	Tall unit		S	30	02	IS2	259	280	294	309	342	367	399	30	48	48	10	10
	1 hinged door		S	45	02	IS2	285	308	324	340	377	404	439	30	48	48	10	10
	1 fixed shelf		S	50	02	IS2	293	317	333	349	387	414	449	30	48	48	10	10
	3 interior drawers		S	60	02	IS2	312	337	356	376	412	442	475	30	48	48	10	10
<p>The hinged doors must open to an angle of at least 90° (observe handle spacing). Door must not be hinged on side adjacent to the worktop.</p>																		
	Tall unit		S	30	02	IS	259	280	294	309	342	367	399	30	48	48	10	10
	1 hinged door		S	45	02	IS	288	311	327	344	380	408	444	30	48	48	10	10
	1 fixed shelf		S	50	02	IS	299	323	341	360	395	424	455	30	48	48	10	10
	3 interior drawers		S	60	02	IS	312	337	356	376	412	442	475	30	48	48	10	10
<p>The hinged doors must open to an angle of at least 90° (observe handle spacing). Door must not be hinged on side adjacent to the worktop.</p> <p>Unit in 450 and 500 mm widths only available for following ranges: IP 1200, IP 2200, IP 3150, IP 4050</p>																		
	Tall unit		S	30	02	IA2	210	226	238	251	283	309	345	20	32	64	10	10
	1 hinged door		S	45	02	IA2	233	252	264	278	320	351	389	20	32	64	10	10
	1 fixed shelf		S	50	02	IA2	244	261	273	287	327	358	397	20	32	64	10	10
	2 interior deep drawers		S	60	02	IA2	254	273	288	305	340	371	411	20	32	64	10	10
<p>The hinged doors must open to an angle of at least 90° (observe handle spacing). Door must not be hinged on side adjacent to the worktop.</p>																		
	Tall unit		S	30	02	IA	209	225	237	250	282	307	342	20	32	64	10	10
	1 hinged door		S	45	02	IA	234	252	265	280	316	344	383	20	32	64	10	10
	1 fixed shelf		S	50	02	IA	244	262	277	293	326	356	393	20	32	64	10	10
	2 interior deep drawers		S	60	02	IA	253	272	287	304	338	369	408	20	32	64	10	10
<p>The hinged doors must open to an angle of at least 90° (observe handle spacing). Door must not be hinged on side adjacent to the worktop.</p> <p>Unit in 450 and 500 mm widths only available for following ranges: IP 1200, IP 2200, IP 3150, IP 4050</p>																		

Illustrations do not correspond to the door finishes.

Tall units

2051 mm high

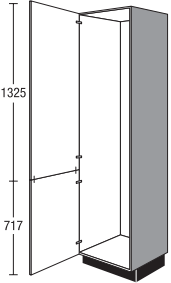
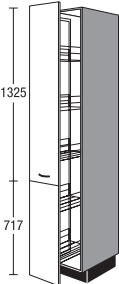





Unit without plinth, carcass depth 560 mm

		width	Price group							Servosoft	Pro Servosoft	ProServoGlass	Soft closing Top Motion	Soft closing Top Motion Plus		
			1	2	3	4	5	6	7							
 <p>Tall unit for individual equipping 1 hinged door (dowelled)</p> <p><i>Grip ledges are fitted at the works to both side-hung doors in order to achieve a continuous joint pattern.</i></p>	S	60	02	Z	151	161	171	182	206	226	252	-	-	-	10	10
 <p>Pull-out tall unit with wire baskets, silver grey 1 full-extension pull-out with cushioning consisting of 2 fronts 5 adjustable baskets</p> <p><i>Handle only fitted horizontally</i></p> <p><i>Grip ledges are fitted at the works to both fronts in order to achieve a continuous joint pattern.</i></p> <p><i>Runner profile top and bottom Baskets can be used from both sides.</i></p>	SA	30	02		263	281	284	287	304	312	329	36	36	36	-	-
 <p>Baskets: clip-on baskets silver grey</p> <p>Suitable additions:</p>																
<p>Hanging basket silver-grey</p>	ZIK	30			6	6	6	6	6	6	6	-	-	-	-	-
<p>Insert tray plastic white 12 mm high</p>	ZIE	30			3	3	3	3	3	3	3	-	-	-	-	-

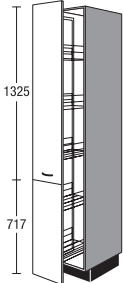
Tall units

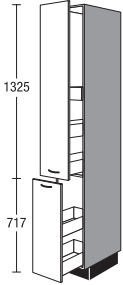
2051 mm high

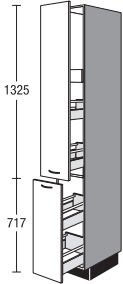
Unit without plinth, carcass depth 560 mm

		width	Price group							Servosoft	Pro Servosoft	ProServodglass	Soft closing Top Motion	Soft closing Top Motion Plus		
			1	2	3	4	5	6	7							
 <p>Pull-out tall unit Baskets with wooden shelf and metal rail 1 full-extension pull-out with cushioning consisting of 2 fronts 5 adjustable baskets <i>Handle only fitted horizontally</i> <i>Grip ledges are fitted at the works to both fronts in order to achieve a continuous joint pattern.</i> <i>Runner profile top and bottom Baskets can be used from both sides.</i></p>  <p>Baskets: wooden shelf and metal rail</p> <p>Suitable additions:</p> <p>Hanging basket Wooden shelf with metal rail</p>	SA	30	02	P	368	386	389	392	409	417	438	-	-	-	-	-
	ZIK	30	P	7	7	7	7	7	7	7	7	7	-	-	-	-
 <p>Tall unit </p> <p>1 deep drawer with 2 drawers 1 internal drawer 1 deep drawer with 2 drawers <i>Handle only fitted horizontally</i> <i>The front panel must be removed to fit handles on ranges IP 4250, IP 7810 CK, IP 7820 CK.</i></p>	SA	30	02	S	197	212	214	218	224	235	253	25	40	40	-	-
 <p>Tall unit </p> <p>1 Auszug mit 2 Auszügen 1 internal drawer 1 Auszug mit 2 Auszügen <i>Handle only fitted horizontally</i> <i>The front panel must be removed to fit handles on ranges IP 4250, IP 7810 CK, IP 7820 CK.</i></p>	SA	30	02	A	209	224	226	230	236	247	265	25	40	40	-	-

Illustrations do not correspond to the door finishes.

Tall units

2051 mm high

Unit without plinth, carcass depth 560 mm

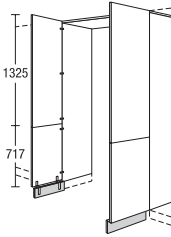
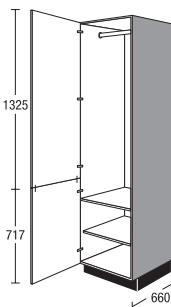
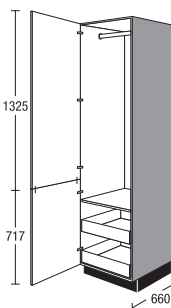
		width	Price group							Servosoft	Pro Servosoft	ProServoGlass	Soft closing Top Motion	Soft closing Top Motion Plus	
			1	2	3	4	5	6	7						
 <p>Access door 2 doors (dowelled) 2 end panels, 16 mm thick, same colour and height as carcass 1 top panel, 16 mm thick, same colour as carcass 2 plinth panels in same colour as carcass, including connecting angle</p> <p>Available for the following ranges: IP 1200, IP 2200, IP 3150, IP 4050</p> <p>Not available in the following plinth decor: 299 Stainless steel effect</p> <p>Only plan between 2 tall units in height 02.</p> <p>The delivery comprises several packages.</p>	DG	90	02		206	222	235	-	-	-	-	-	-	20	20
	DG	100	02		211	227	241	-	-	-	-	-	-	20	20
 <p>Tall unit with clothes rail NEW Carcass depth 660 mm</p> <p>1 door (dowelled) 1 garment rail 1 fixed shelf 1 adjustable shelf</p> <p>Grip ledges are fitted at the works to both side-hung doors in order to achieve a continuous joint pattern.</p>	S	45	02	66G1	188	204	213	228	250	271	299	-	-	10	10
	S	50	02	66G1	197	213	223	239	262	285	313	-	-	10	10
	S	60	02	66G1	219	236	250	266	297	326	361	-	-	10	10
 <p>Tall unit with clothes rail NEW Carcass depth 660 mm</p> <p>1 door (dowelled) 1 garment rail 1 fixed shelf 2 internal drawers</p> <p>Grip ledges are fitted at the works to both side-hung doors in order to achieve a continuous joint pattern.</p>	S	45	02	66GIS	242	251	261	272	295	316	345	-	-	10	10
	S	50	02	66GIS	251	261	271	283	306	328	357	-	-	10	10
	S	60	02	66GIS	273	284	294	307	333	357	389	-	-	10	10

4.82 Illustrations do not correspond to the door finishes.

Diagonal tall units

2051 mm high

Unit without plinth, carcass depth 560 mm

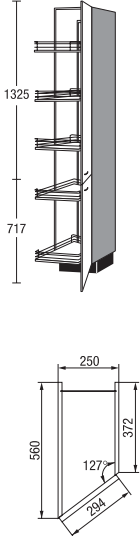
				Price group												
				width	1	2	3	4	5	6	7	Servosoft	Pro Servosoft	ProServoglass	Soft closing Top Motion	Soft closing Top Motion Plus
 <p>3-D tall unit 560/372 mm deep 1 hinged door (dowelled) 1 basket trolley with 5 adjustable baskets</p> <p><i>Grip ledges are fitted at the works to both side-hung doors in order to achieve a continuous joint pattern.</i></p> <p>Suitable additions:</p> <p>Hanging basket silver-grey</p>	SV	25	02	T	404	425	429	432	452	461	485	-	-	-	-	-
	ZIK 25 T				11	11	11	11	11	11	11	-	-	-	-	-

Illustrations do not correspond to the door finishes.

Appliance housings with niche height 880 mm

2051 mm high

Unit without plinth, carcass depth 560 mm

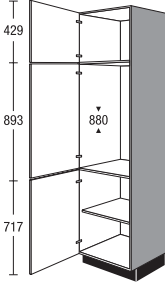
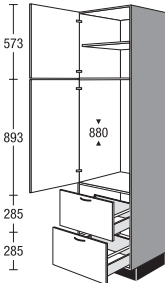
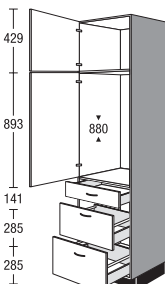
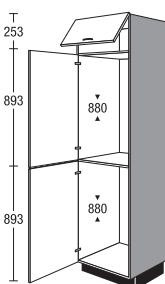
	width	Price group							Servosoft	Pro Servosoft	ProServoGlass	Soft closing Top Motion	Soft closing Top Motion Plus	
		1	2	3	4	5	6	7						
 <p>Tall unit for appliances Niche height 880 mm</p> <p>1 hinged door 1 hinged appliance door 1 hinged door 1 adjustable shelf</p> <p><i>For cladding up to the ceiling, provision must be made for a ventilation opening of min. 200 cm² in diameter.</i></p> <p>G88 02 SIA</p>	G88	02	150	162	175	189	221	248	282	-	-	-	12	12
 <p>Tall unit for appliances Niche height 880 mm</p> <p>1 hinged door 1 adjustable shelf 1 hinged appliance door 2 deep drawers</p> <p><i>For cladding up to the ceiling, provision must be made for a ventilation opening of min. 200 cm² in diameter.</i></p> <p>G882A 02 XSIA</p>	G882A	02 X	199	210	224	238	262	289	322	10	16	32	8	8
 <p>Tall unit for appliances Niche height 880 mm</p> <p>1 hinged door 1 hinged appliance door 1 drawer 2 deep drawers</p> <p><i>For cladding up to the ceiling, provision must be made for a ventilation opening of min. 200 cm² in diameter.</i></p> <p>G88S2A 02 SIA</p>	G88S2A	02	225	237	252	268	296	326	363	15	24	40	8	8
 <p>Tall unit for appliances Niche height 880 mm Niche height 880 mm</p> <p>1 flap door 2 hinged appliance doors</p> <p><i>niche size adjustment partially with infill panels.</i></p> <p><i>For cladding up to the ceiling, provision must be made for a ventilation opening of min. 200 cm² in diameter.</i></p> <p>G8888 02 K3STB</p>	G8888	02 K3	167	182	193	206	230	252	280	-	-	-	12	22

Appliance housings with niche height 880 mm, Appliance housings with niche height 1025 mm

2051 mm high

Unit without plinth, carcass depth 560 mm

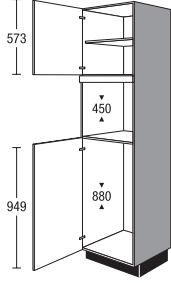
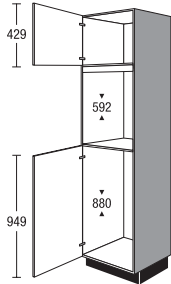
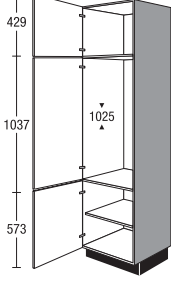
		width	Price group							Servosoft	Pro Servosoft	ProServodiamond	Soft closing Top Motion	Soft closing Top Motion Plus			
			1	2	3	4	5	6	7								
 <p>Tall unit for appliances Niche height 450 mm Niche height 880 mm</p> <p>1 hinged door 1 adjustable shelf 1 appliance door</p> <p><i>One front panel per appliance type will be provided for adaptation on site.</i></p> <p><i>Recess sizes are adjusted in part through the use of carcass panels.</i></p> <p><i>Version supplied may deviate from the illustration according to appliance type.</i></p> <p><i>For cladding up to the ceiling, provision must be made for a ventilation opening of min. 200 cm² in diameter.</i></p> <p>G88M 02 4SOA</p>	G88M	02	4	168	179	185	191	219	239	263	-	-	-	10	10		
	 <p>Tall unit for appliances Niche height 592 mm Niche height 880 mm</p> <p>1 hinged door 1 hinged appliance door</p> <p><i>One front panel per appliance type will be provided for adaptation on site.</i></p> <p><i>Recess sizes are adjusted in part through the use of carcass panels.</i></p> <p><i>Version supplied may deviate from the illustration according to appliance type.</i></p> <p><i>For cladding up to the ceiling, provision must be made for a ventilation opening of min. 200 cm² in diameter.</i></p> <p><i>For foil-wrapped fronts a set of heat deflector plates are supplied free of charge.</i></p> <p>G88B 02 4SPF</p>	G88B	02	4	176	188	194	200	229	251	276	-	-	-	10	10	
		 <p>Tall unit for appliances niche height 1025 mm</p> <p>1 hinged door 1 hinged appliance door 1 hinged door 1 adjustable shelf</p> <p><i>For cladding up to the ceiling, provision must be made for a ventilation opening of min. 200 cm² in diameter.</i></p> <p>G102 02 XSLC</p>	G102	02	X	161	173	182	191	226	243	265	-	-	-	14	14

Illustrations do not correspond to the door finishes.

4.85

Appliance housings with niche height 1025 mm, Appliance housings with niche height 1225 mm

2051 mm high

Unit without plinth, carcass depth 560 mm

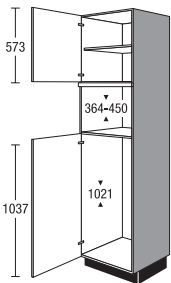
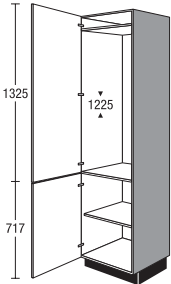
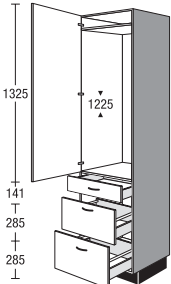
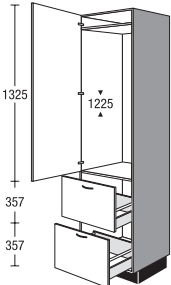
	width	Price group							Servosoft	Pro Servosoft	ProServoGlass	Soft closing Top Motion	Soft closing Top Motion Plus		
		1	2	3	4	5	6	7							
 <p>Tall unit for appliances Recess height 364 - 450 mm niche height 1021 mm</p> <p>1 hinged door 1 adjustable shelf 1 appliance door</p> <p><i>One front panel per appliance type will be provided for adaptation on site.</i></p> <p><i>Version supplied may deviate from the illustration according to appliance type.</i></p> <p><i>For cladding up to the ceiling, provision must be made for a ventilation opening of min. 200 cm² in diameter.</i></p> <p><i>Depending on type with metal plinth shelf.</i></p> <p>G102M 02 5SPC</p>	G102M	02	5	201	214	228	242	258	280	305	-	-	-	10	10
 <p>Tall unit for appliances niche height 1225 mm</p> <p>1 appliance door 1 hinged door 1 adjustable shelf</p> <p><i>niche size adjustment partially with infill panels.</i></p> <p><i>Version supplied may deviate from the illustration according to appliance type.</i></p> <p><i>For cladding up to the ceiling, provision must be made for a ventilation opening of min. 200 cm² in diameter.</i></p> <p>G 122 02 SNL</p>	G122	02		151	165	178	192	223	243	269	-	-	-	10	10
 <p>Tall unit for appliances niche height 1225 mm</p> <p>1 appliance door 1 drawer 2 deep drawers</p> <p><i>niche size adjustment partially with infill panels.</i></p> <p><i>Version supplied may deviate from the illustration according to appliance type.</i></p> <p><i>For cladding up to the ceiling, provision must be made for a ventilation opening of min. 200 cm² in diameter.</i></p> <p>G122S2A 02 SNL</p>	G122S2A	02		218	230	244	260	287	316	352	15	24	40	6	6
 <p>Tall unit for appliances niche height 1225 mm</p> <p>1 appliance door 2 deep drawers</p> <p><i>niche size adjustment partially with infill panels.</i></p> <p><i>Version supplied may deviate from the illustration according to appliance type.</i></p> <p><i>For cladding up to the ceiling, provision must be made for a ventilation opening of min. 200 cm² in diameter.</i></p> <p>G1222A 02 SNL</p>	G1222A	02		192	204	213	224	246	266	291	10	16	32	6	6

4.86 Illustrations do not correspond to the door finishes.

Appliance housings with niche height 1225 mm, Appliance housings with niche height 1400 mm

2051 mm high

Unit without plinth, carcass depth 560 mm

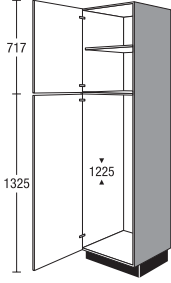
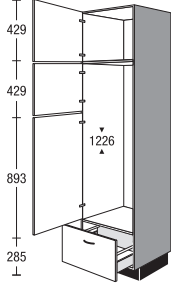
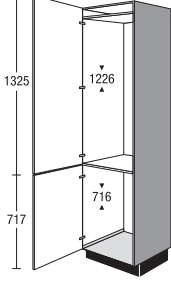
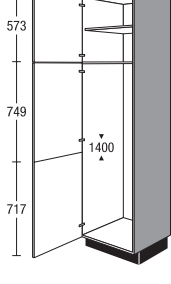
	width	Price group							Servosoft	Pro Servosoft	ProServoglass	Soft closing Top Motion	Soft closing Top Motion Plus		
		1	2	3	4	5	6	7							
 <p>Tall unit for appliances niche height 1225 mm</p> <p>1 hinged door 1 adjustable shelf 1 appliance door</p> <p><i>niche size adjustment partially with infill panels.</i></p> <p><i>Version supplied may deviate from the illustration according to appliance type.</i></p> <p><i>For cladding up to the ceiling, provision must be made for a ventilation opening of min. 200 cm² in diameter.</i></p> <p>G122 02 9SNL</p>	G122	02	9	152	165	178	192	223	243	269	-	-	-	10	10
 <p>Tall unit for appliances Niche height 1226 mm</p> <p>1 hinged door 1-2 appliance doors 1 deep drawer</p> <p><i>Version supplied may deviate from the illustration according to appliance type.</i></p> <p><i>For cladding up to the ceiling, provision must be made for a ventilation opening of min. 200 cm² in diameter.</i></p> <p><i>For ergonomic reasons, the hinged door for appliances is split when handle strips and recessed grips are planned.</i> <i>Front dimension bottom: 429 mm, top: 893 mm</i></p> <p>G122A 02 SNI</p>	G122A	02		177	191	205	219	249	268	293	5	8	16	10	10
 <p>Tall unit for appliances Niche height 1226 mm Recess height 716 mm</p> <p>2 hinged appliance doors</p> <p><i>niche size adjustment partially with infill panels.</i></p> <p><i>Version supplied may deviate from the illustration according to appliance type.</i></p> <p><i>For cladding up to the ceiling, provision must be made for a ventilation opening of min. 200 cm² in diameter.</i></p> <p>G12272 02 SVF</p>	G12272	02		182	199	211	225	252	276	308	-	-	-	10	10
 <p>Tall unit for appliances Niche height 1400 mm</p> <p>1 hinged door 1 adjustable shelf 1 hinged appliance door (pinned)</p> <p><i>niche size adjustment partially with infill panels.</i></p> <p><i>Version supplied may deviate from the illustration according to appliance type.</i></p> <p><i>Grip ledges are fitted to both appliance side-hung doors at the works in order to achieve a continuous joint pattern.</i></p> <p><i>For cladding up to the ceiling, provision must be made for a ventilation opening of min. 200 cm² in diameter.</i></p> <p>G140 02 SPA</p>	G140	02		158	171	185	200	232	253	279	-	-	-	12	12

Illustrations do not correspond to the door finishes.

Appliance housings with niche height 1445 mm

2051 mm high

Unit without plinth, carcass depth 560 mm

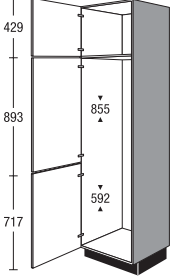
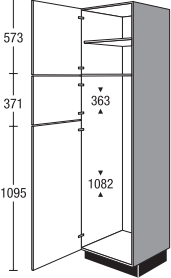
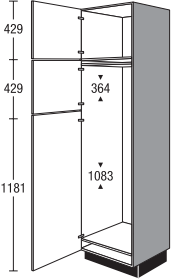
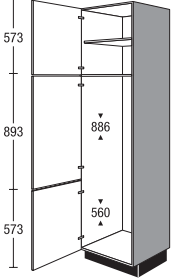
	width	Price group							Servosoft	Pro Servosoft	ProServoGlass	Soft closing Top Motion	Soft closing Top Motion Plus	
		1	2	3	4	5	6	7						
 <p>Tall unit for appliances Recess height 855 mm Niche height 592 mm 1 hinged door 2 hinged appliance doors <i>niche size adjustment partially with infill panels.</i> <i>Version supplied may deviate from the illustration according to appliance type.</i> For cladding up to the ceiling, provision must be made for a ventilation opening of min. 200 cm² in diameter.</p> <p>G145 02 SPE</p>	G145	02	155	168	181	196	228	248	274	-	-	-	12	12
 <p>Tall unit for appliances Recess height 363 mm Recess height 1082 mm 1 hinged door 1 adjustable shelf 2 hinged appliance doors <i>niche size adjustment partially with infill panels.</i> <i>Version supplied may deviate from the illustration according to appliance type.</i> For cladding up to the ceiling, provision must be made for a ventilation opening of min. 200 cm² in diameter.</p> <p>G145 02 6SPK</p>	G145	02 6	153	166	179	194	225	245	271	-	-	-	14	14
 <p>Tall unit for appliances Recess height 364 mm Recess height 1083 mm 1 hinged door 2 hinged appliance doors <i>niche size adjustment partially with infill panels.</i> <i>Version supplied may deviate from the illustration according to appliance type.</i> For cladding up to the ceiling, provision must be made for a ventilation opening of min. 200 cm² in diameter.</p> <p>G145 02 8SPK</p>	G145	02 8	153	166	179	194	225	245	271	-	-	-	14	14
 <p>Tall unit for appliances Recess height 886 mm Recess height 560 mm 1 hinged door 1 adjustable shelf 2 hinged appliance doors <i>niche size adjustment partially with infill panels.</i> <i>Version supplied may deviate from the illustration according to appliance type.</i> For cladding up to the ceiling, provision must be made for a ventilation opening of min. 200 cm² in diameter.</p> <p>G145 02 XSPM</p>	G145	02 X	152	165	178	192	223	243	269	-	-	-	12	12

4.88 Illustrations do not correspond to the door finishes.

Appliance housings with niche height 1580 mm, Appliance housings with niche height 1780 mm

2051 mm high

Unit without plinth, carcass depth 560 mm

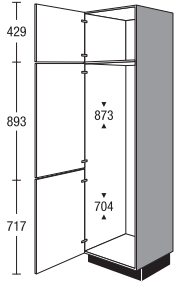
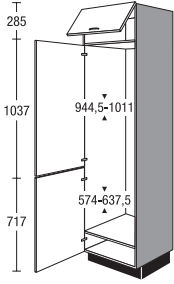
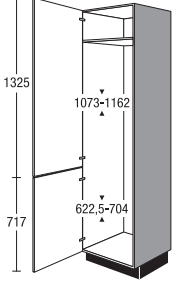
	width	Price group							Servosoft	Pro Servosoft	ProServoGlass	Soft closing Top Motion	Soft closing Top Motion Plus	
		1	2	3	4	5	6	7						
 <p>Tall unit for appliances Recess height 873 mm niche height 704 mm</p> <p>1 hinged door 2 hinged appliance doors for opening together or separately, according to finish and type of appliance</p> <p><i>niche size adjustment partially with infill panels.</i></p> <p><i>Version supplied may deviate from the illustration according to appliance type.</i></p> <p><i>Grip ledges are fitted at the works to both appliance doors that open together in order to achieve a continuous joint pattern.</i></p> <p><i>For cladding up to the ceiling, provision must be made for a ventilation opening of min. 200 cm² in diameter.</i></p> <p>G158 02 SRT</p>	G158	02	150	162	176	190	220	240	265	-	-	-	12	12
 <p>Tall unit for appliances Recess height 944.5 - 1011 mm Recess height 574 - 637.5 mm</p> <p>1 flap door 2 hinged appliance doors</p> <p><i>niche size adjustment partially with infill panels.</i></p> <p><i>Version supplied may deviate from the illustration according to appliance type.</i></p> <p><i>For cladding up to the ceiling, provision must be made for a ventilation opening of min. 200 cm² in diameter.</i></p> <p>G158 02 KSRG</p>	G158	02 K	161	174	188	203	235	256	282	-	-	-	14	24
 <p>Tall unit for appliances Recess height 1073 - 1162 mm Recess height 622.5 - 704 mm</p> <p>2 hinged appliance doors for opening together or separately, according to finish and type of appliance</p> <p><i>niche size adjustment partially with infill panels.</i></p> <p><i>Version supplied may deviate from the illustration according to appliance type.</i></p> <p><i>Grip ledges are fitted at the works to both appliance doors that open together in order to achieve a continuous joint pattern.</i></p> <p><i>For cladding up to the ceiling, provision must be made for a ventilation opening of min. 200 cm² in diameter.</i></p> <p>G178 02 STD</p>	G178	02	144	158	168	177	204	229	259	-	-	-	10	10

Illustrations do not correspond to the door finishes.

Appliance housings with aperture height 1890 mm, Appliance housings with niche height 1940 mm, Appliance housings with niche height 380 mm

2051 mm high

Unit without plinth, carcass depth 560 mm

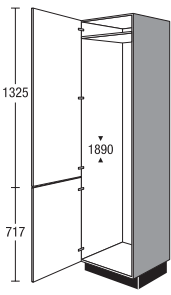
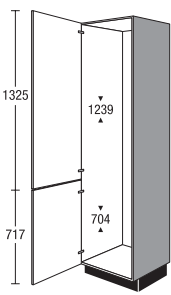
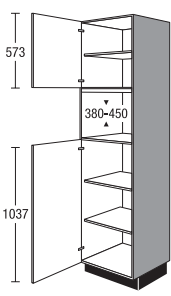
	width	Price group							Servosoft	Pro Servosoft	ProServoGlass	Soft closing Top Motion	Soft closing Top Motion Plus	
		1	2	3	4	5	6	7						
 <p>Tall unit for appliances Recess height 1890 mm 2 hinged appliance doors for opening together or separately, according to finish and type of appliance <i>niche size adjustment partially with infill panels.</i> <i>Version supplied may deviate from the illustration according to appliance type.</i> <i>For cladding up to the ceiling, provision must be made for a ventilation opening of min. 200 cm² in diameter.</i></p> <p>G189 02 SUH</p>	G189	02	167	183	195	205	237	266	300	-	-	-	10	10
 <p>Tall unit for appliances Recess height 1239 mm niche height 704 mm 2 hinged appliance doors <i>niche size adjustment partially with infill panels.</i> <i>Version supplied may deviate from the illustration according to appliance type.</i> <i>For cladding up to the ceiling, provision must be made for a ventilation opening of min. 200 cm² in diameter.</i></p> <p>G194 02 SVE</p>	G194	02	148	163	172	182	210	235	267	-	-	-	10	10
 <p>Tall unit for appliances niche height 380 or 450 mm 1 hinged door 1 adjustable shelf 1 hinged door 2 adjustable shelves <i>Recess sizes are adjusted in part through the use of carcass panels.</i> <i>One front panel per appliance type will be provided for adaptation on site.</i> <i>For cladding up to the ceiling, provision must be made for a ventilation opening of min. 200 cm² in diameter.</i></p> <p>GM 02 5DF</p>	GM	02 5	199	215	229	243	259	283	310	-	-	-	10	10

4.90 Illustrations do not correspond to the door finishes.

Appliance housings with niche height 450 mm

2051 mm high

Unit without plinth, carcass depth 560 mm

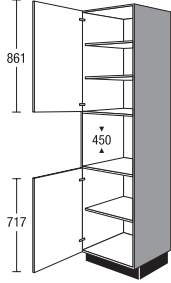
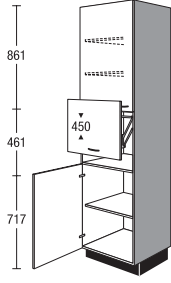
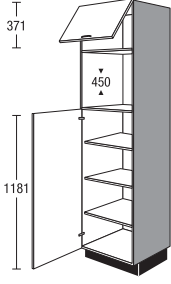
		width	Price group							Servosoft	Pro Servosoft	ProServoglass	Soft closing Top Motion	Soft closing Top Motion Plus
			1	2	3	4	5	6	7					
 <p>Tall unit for appliances Niche height 450 mm</p> <p>1 hinged door 2 adjustable shelves 1 hinged door 1 adjustable shelf</p> <p><i>For cladding up to the ceiling, provision must be made for a ventilation opening of min. 200 cm² in diameter.</i></p> <p>GM 02 EE</p>	GM	02	156	167	176	187	206	217	233	-	-	-	8	8
	 <p>Tall unit for appliances with lift-up door Niche height 450 mm</p> <p>same as above, but plus 1 lift-up door</p> <p>Maximum size of stand-alone Height 400 mm Width 510 mm Depth: 540</p> <p>430 mm opening height for lift-up door</p> <p>GM 02 L</p>	GM	02 L	221	237	250	266	294	310	334	-	-	-	8
 <p>Tall unit for appliances Niche height 450 mm</p> <p>1 flap door 1 hinged door 3 adjustable shelves</p> <p><i>Recess sizes are adjusted in part through the use of carcass panels.</i></p> <p><i>For cladding up to the ceiling, provision must be made for a ventilation opening of min. 200 cm² in diameter.</i></p> <p>GM 02 K8EE</p>		GM	02 K8	162	173	184	195	208	227	248	-	-	-	10

Illustrations do not correspond to the door finishes.

4.91

Appliance housings with niche height 450 mm, Appliance housings with niche height 590 mm

2051 mm high

Unit without plinth, carcass depth 560 mm

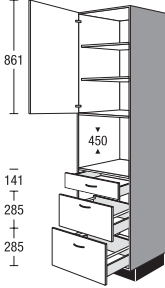
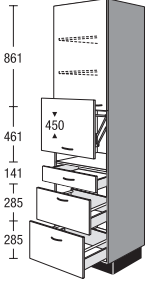
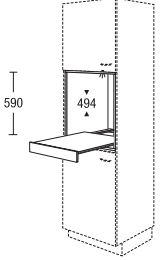
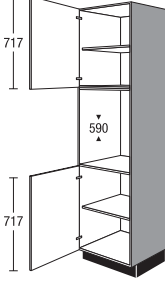
		width	Price group							Servosoft	Pro Servosoft	ProServoGlass	Soft closing Top Motion	Soft closing Top Motion Plus
			1	2	3	4	5	6	7					
 <p>Tall unit for appliances Niche height 450 mm 1 hinged door 2 adjustable shelves 1 drawer 2 deep drawers</p> <p><i>For cladding up to the ceiling, provision must be made for a ventilation opening of min. 200 cm² in diameter.</i></p> <p>GMS2A 02 EE</p>	GMS2A	02	220	237	252	266	292	320	351	15	24	40	4	4
	 <p>Tall unit for appliances Niche height 450 mm same as above, but plus 1 lift-up door</p> <p>Maximum size of stand-alone Height 400 mm Width 510 mm Depth: 540</p> <p>430 mm opening height for lift-up door</p> <p>GMS2A 02 L</p>	GMS2A	02 L	290	312	332	351	385	422	463	15	24	40	4
 <p>Modular built in shelf unit for highboard / tall unit for niche heights 590 mm Depth: 505 mm</p> <p>1 pull-out shelf</p> <p><i>Finish in carcass material</i> <i>Not available in visible side colours.</i></p>	MR	60 59 TA	201	201	201	201	201	201	201	-	-	-	-	-
 <p>Tall unit for appliances niche height 590 mm 1 hinged door 1 adjustable shelf 1 hinged door 1 adjustable shelf</p> <p><i>For cladding up to the ceiling, provision must be made for a ventilation opening of min. 200 cm² in diameter.</i></p> <p><i>For foil-wrapped fronts a set of heat deflector plates are supplied free of charge.</i></p> <p>GB 02 FB</p>	GB	02	143	153	162	172	190	201	216	-	-	-	8	8

4.92 Illustrations do not correspond to the door finishes.

Appliance housings with niche height 590 mm

2051 mm high

Unit without plinth, carcass depth 560 mm

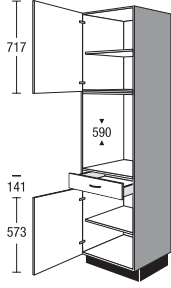
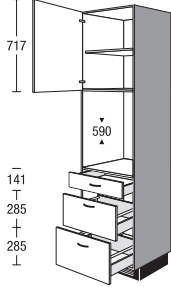
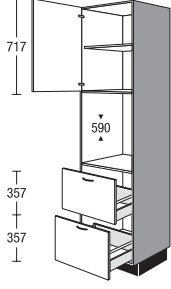
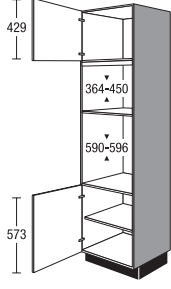
		width	Price group							Servosoft	Pro Servosoft	ProServoglass	Soft closing Top Motion	Soft closing Top Motion Plus
			1	2	3	4	5	6	7					
 <p>Tall unit for appliances niche height 590 mm</p> <p>1 hinged door 1 adjustable shelf 1 drawer 1 hinged door 1 adjustable shelf</p> <p><i>For cladding up to the ceiling, provision must be made for a ventilation opening of min. 200 cm² in diameter.</i></p> <p><i>For foil-wrapped fronts a set of heat deflector plates are supplied free of charge.</i></p> <p>GBS 02 FB</p>	GBS	02	163	175	185	196	217	229	246	5	8	8	8	8
	 <p>Tall unit for appliances niche height 590 mm</p> <p>1 hinged door 1 adjustable shelf 1 drawer 2 deep drawers</p> <p><i>For cladding up to the ceiling, provision must be made for a ventilation opening of min. 200 cm² in diameter.</i></p> <p><i>For foil-wrapped fronts a set of heat deflector plates are supplied free of charge.</i></p> <p>GBS2A 02 FB</p>	GBS2A	02	226	243	259	274	300	329	360	15	24	40	4
 <p>Tall unit for appliances niche height 590 mm</p> <p>1 hinged door 1 adjustable shelf 2 deep drawers</p> <p><i>For cladding up to the ceiling, provision must be made for a ventilation opening of min. 200 cm² in diameter.</i></p> <p><i>For foil-wrapped fronts a set of heat deflector plates are supplied free of charge.</i></p> <p>GB2A 02 FB</p>	GB2A	02	205	227	241	254	277	302	330	10	16	32	4	4
 <p>Tall unit for appliances Recess height 364 - 450 mm Recess height 590 - 596 mm</p> <p>1 hinged door 1 hinged door 1 adjustable shelf</p> <p><i>One front panel per appliance type will be provided for adaptation on site.</i></p> <p><i>For cladding up to the ceiling, provision must be made for a ventilation opening of min. 200 cm² in diameter.</i></p> <p><i>For foil-wrapped fronts a set of heat deflector plates are supplied free of charge.</i></p> <p>GMB 02 XLA</p>	GMB	02 X	153	173	182	192	205	226	250	-	-	-	8	8

Illustrations do not correspond to the door finishes.

Appliance housings with niche height 590 mm

2051 mm high

Unit without plinth, carcass depth 560 mm

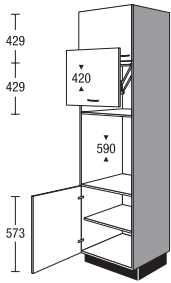
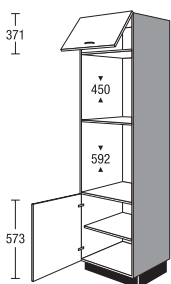
	GMB	width	02	LX	Price group							Servosoft	Pro Servosoft	ProServoGlass	Soft closing Top Motion	Soft closing Top Motion Plus
					1	2	3	4	5	6	7					
 <p>Tall unit for appliances with lift-up door Recess height 420 mm niche height 590 mm same as above, but plus 1 lift-up door Maximum size of stand-alone Height 370 mm Width 510 mm Depth: 540 mm 430 mm opening height for lift-up door</p> <p>GMB 02 LXFB</p>	GMB		02	LX	218	247	261	275	295	326	361	-	-	-	8	8
 <p>Tall unit for appliances Niche height 450 mm Niche height 592 mm 1 flap door 1 hinged door 1 adjustable shelf <i>One front panel per appliance type will be provided for adaptation on site.</i> <i>For cladding up to the ceiling, provision must be made for a ventilation opening of min. 200 cm² in diameter.</i> <i>For foil-wrapped fronts a set of heat deflector plates are supplied free of charge.</i></p> <p>GMB 02 KXLD</p>	GMB		02	KX	155	176	185	195	208	230	254	-	-	-	8	18

4.94 Illustrations do not correspond to the door finishes.

Appliance housings with niche height 590 mm

2051 mm high

Unit without plinth, carcass depth 560 mm

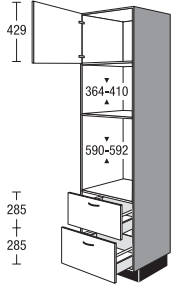
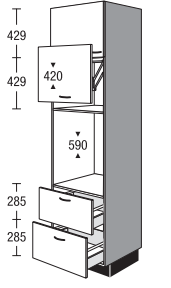
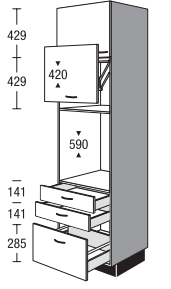
		width	Price group							Servosoft	Pro Servosoft	ProServoglass	Soft closing Top Motion	Soft closing Top Motion Plus	
			1	2	3	4	5	6	7						
 <p>Tall unit for appliances Recess height 364 - 410 mm Recess height 590 - 592 mm 1 hinged door 2 deep drawers</p> <p><i>One front panel per appliance type will be provided for adaptation on site.</i></p> <p><i>For cladding up to the ceiling, provision must be made for a ventilation opening of min. 200 cm² in diameter.</i></p> <p><i>For foil-wrapped fronts a set of heat deflector plates are supplied free of charge.</i></p> <p>GMB2A 02 XLA</p>	GMB2A	02	X	196	217	227	238	251	274	300	10	16	32	4	4
	 <p>Tall unit for appliances with lift-up door Recess height 420 mm niche height 590 mm same as above, but plus 1 lift-up door</p> <p>Maximum size of stand-alone Height 370 mm Width 510 mm Depth: 540 mm</p> <p>430 mm opening height for lift-up door</p> <p>GMB2A 02 LXFB</p>	GMB2A	02	LX	261	290	303	318	336	368	403	10	16	32	4
 <p>Tall unit for appliances with lift-up door Recess height 420 mm niche height 590 mm same as above, but plus 1 lift-up door</p> <p>Maximum size of stand-alone Height 340 mm Width 510 mm Depth: 540 mm</p> <p>430 mm opening height for lift-up door</p> <p><i>For cladding up to the ceiling, provision must be made for a ventilation opening of min. 200 cm² in diameter.</i></p> <p><i>For foil-wrapped fronts a set of heat deflector plates are supplied free of charge.</i></p>		GMB2SA	02	LX	265	283	298	313	340	372	408	15	24	32	4

Illustrations do not correspond to the door finishes.

4.95

Appliance housings with niche height 590 mm

2051 mm high

Unit without plinth, carcass depth 560 mm

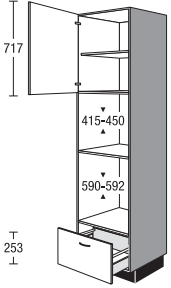
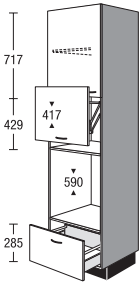
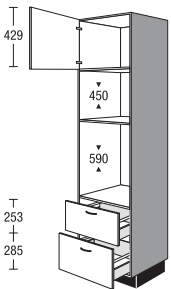
	width	Price group							Servosoft	Pro Servosoft	ProServoGlass	Soft closing Top Motion	Soft closing Top Motion Plus	
		1	2	3	4	5	6	7						
 <p>Tall unit for appliances Recess height 415 - 450 mm Niche height 590 - 592 mm</p> <p>1 hinged door 1 adjustable shelf 1 deep drawer</p> <p><i>One front panel per appliance type will be provided for adaptation on site.</i></p> <p><i>Recess sizes are adjusted in part through the use of carcass panels.</i></p> <p><i>Version supplied may deviate from the illustration according to appliance type.</i></p> <p><i>For foil-wrapped fronts a set of heat deflector plates are supplied free of charge.</i></p> <p>GMBA 02 LD</p>	GMBA	02	158	174	181	188	197	214	233	5	8	16	4	4
 <p>Tall unit for appliances with lift-up door</p> <p>Recess height 417 mm niche height 590 mm</p> <p>same as above, but plus 1 lift-up door</p> <p>Maximum size of stand-alone Height 370 mm Width 510 mm Depth: 540 mm</p> <p>430 mm opening height for lift-up door</p> <p>GMBA 02 LFB</p>	GMBA	02 L	228	251	261	271	284	309	336	5	8	16	4	4
 <p>Tall unit for appliances</p> <p>Niche height 450 mm niche height 590 mm</p> <p>1 hinged door 2 deep drawers</p> <p><i>One front panel per appliance type will be provided for adaptation on site.</i></p> <p><i>For cladding up to the ceiling, provision must be made for a ventilation opening of min. 200 cm² in diameter.</i></p> <p><i>For foil-wrapped fronts a set of heat deflector plates are supplied free of charge.</i></p> <p>GMB2A 02 YLD</p>	GMB2A	02 Y	176	195	205	215	226	248	272	10	16	32	4	4

4.96

Illustrations do not correspond to the door finishes.

Tall shelf units

2051 mm high

Unit without plinth, carcass depth 560 mm

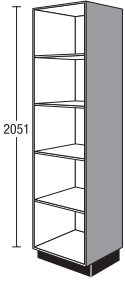
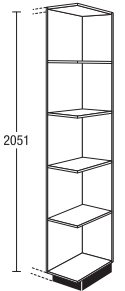
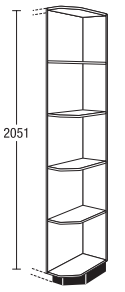
				Price group															
				width								Servosoft	Pro Servosoft	ProServoglass	Soft closing Top Motion	Soft closing Top Motion Plus			
					1	2	3	4	5	6	7								
	Tall shelf unit 4 adjustable shelves <i>Finish in carcass material</i> Please indicate desired width (150-600 mm). Not available in visible side colours.			SR	V	02	229	229	229	229	229	229	229	-	-	-	-	-	
 <p>Version R</p>	Tall end shelf unit 4 fixed shelves Measurements with worktop 290 mm Measurements with modular panel 275 mm Finish in carcass material Available in all carcass finishes. Additional colour variants: 112 Cappuccino 121 Thyme 133 Volcano brown 134 Alby Blue 158 Sage green 952 Petrol Not available in visible side colours.			SRA	30	02	166	166	166	166	166	166	166	-	-	-	-	-	
 <p>Version R</p>	Tall end shelf unit angled 4 fixed shelves Finish in carcass material Not available in visible side colours.			SRA	25	02	S	154	154	154	154	154	154	154	154	-	-	-	-

Illustrations do not correspond to the door finishes.

Filler panels, Miscellaneous

2051 mm high

with neutral door division

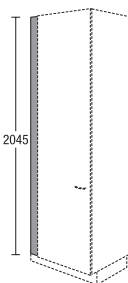
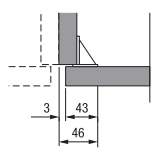
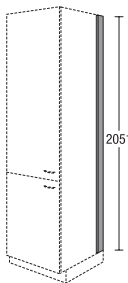
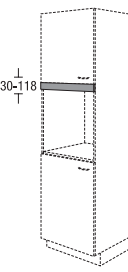
		width	Price group							Servosoft	Pro Servosoft	ProServoGlass	Soft closing Top Motion	Soft closing Top Motion Plus	
			1	2	3	4	5	6	7						
 <p>Infill panel for tall unit without plinth, 2051 mm high Fitted between wall and carcass side</p> <p><i>Finish in continuous door material without edging on the wall side</i></p> <p><i>Not available in visible side colours.</i></p> <p><i>Due to the installation angle, the maximum possible on-site width reduction is 46 mm.</i></p>	SPF	10	02	E	28	31	33	34	36	39	43	-	-	-	-
	SPF	20	02	E	37	40	42	44	49	53	59	-	-	-	-
 <p>Infill panel for tall unit without plinth, 2051 mm high</p> <p><i>Finish in carcass material</i></p> <p><i>Not available in visible side colours.</i></p>	SPK	10	02		19	19	19	19	19	19	19	-	-	-	-
	SPK	20	02		25	25	25	25	25	25	25	-	-	-	-
	SPK	30	02		30	30	30	30	30	30	30	-	-	-	-
 <p>Infill panel for tall-unit side for wall join etc.</p> <p>without plinth, 2051 mm high</p> <p><i>Finish in carcass material</i></p> <p><i>for deeper units, order plinth SO 151 separately</i></p> <p><i>Not available in visible side colours.</i></p>	SPT	10	02		19	19	19	19	19	19	19	-	-	-	-
	SPT	20	02		22	22	22	22	22	22	22	-	-	-	-
	SPT	30	02		25	25	25	25	25	25	25	-	-	-	-
 <p>Door material infill panel for appliance housing units</p> <p>For covering the carcass inner panel with edge protection stainless steel coloured</p> <p>Height 30-118 mm</p> <p><i>Please state the desired height.</i></p>	FBG	60		G	25	29	30	31	33	35	40	-	-	-	-

Filler panels, Miscellaneous

2051 mm high

with neutral door division

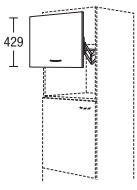
				Price group													
				width	1	2	3	4	5	6	7	Servosoft	Pro Servosoft	ProServoglass	Soft closing Top Motion	Soft closing Top Motion Plus	
<p>Door material infill panel for appliance housing units</p> <p>For covering the carcass inner panel with edge protection stainless steel coloured</p> <p>Height 118 mm for on-site adaptation</p>				FBG	60	Z											
 <p>Lift-up door for microwave niche for retrofitting on site</p> <p>For tall units / highboards with niche height 410 mm</p> <p>Max. size of standing appliance Height: 370 mm Width: 510 mm Depth: 540 mm</p> <p><i>370 mm opening height for lift-up door</i></p>				LKP	60	43											

Illustrations do not correspond to the door finishes.

4.99

Notes

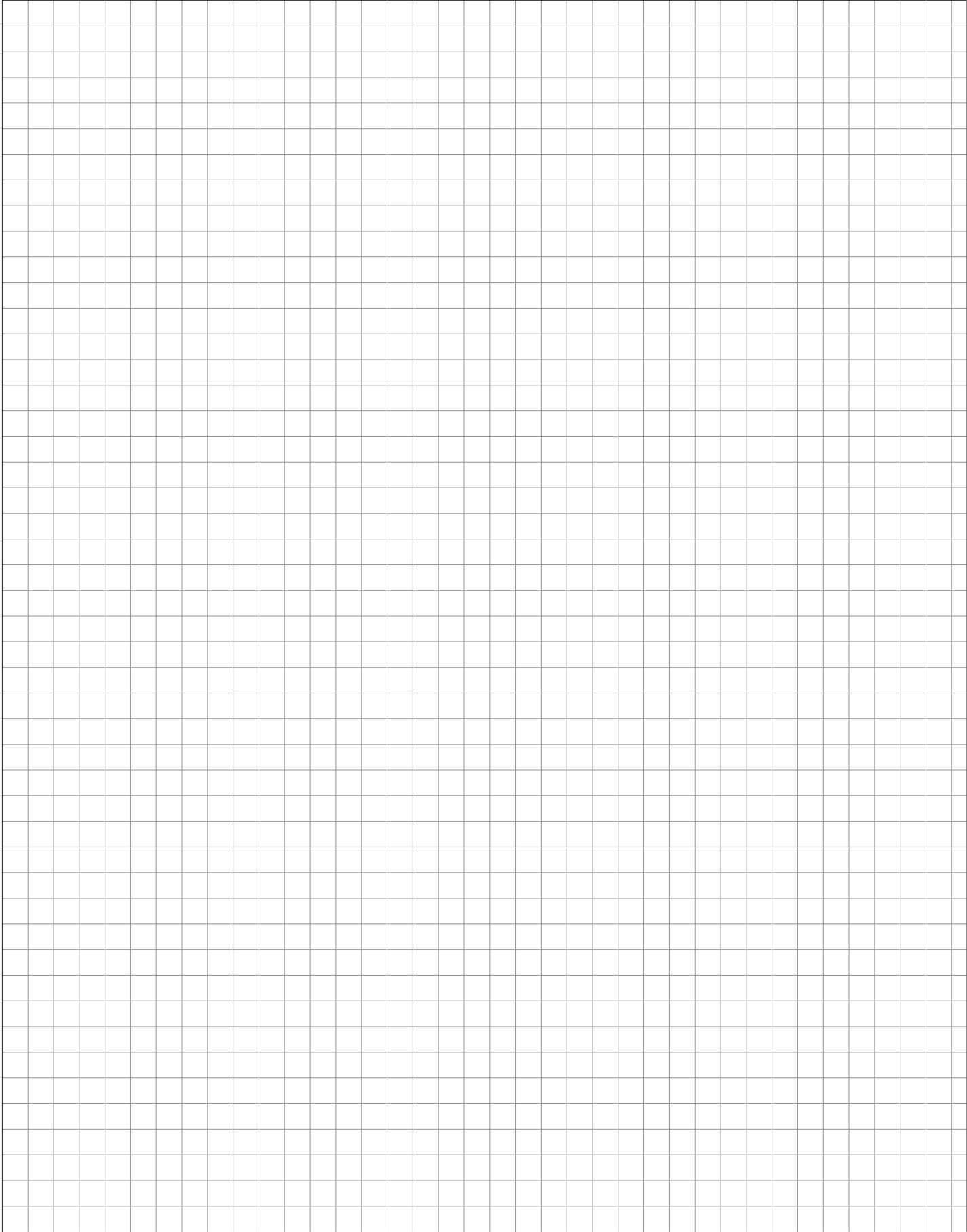

Tall units 2195 mm, height 03

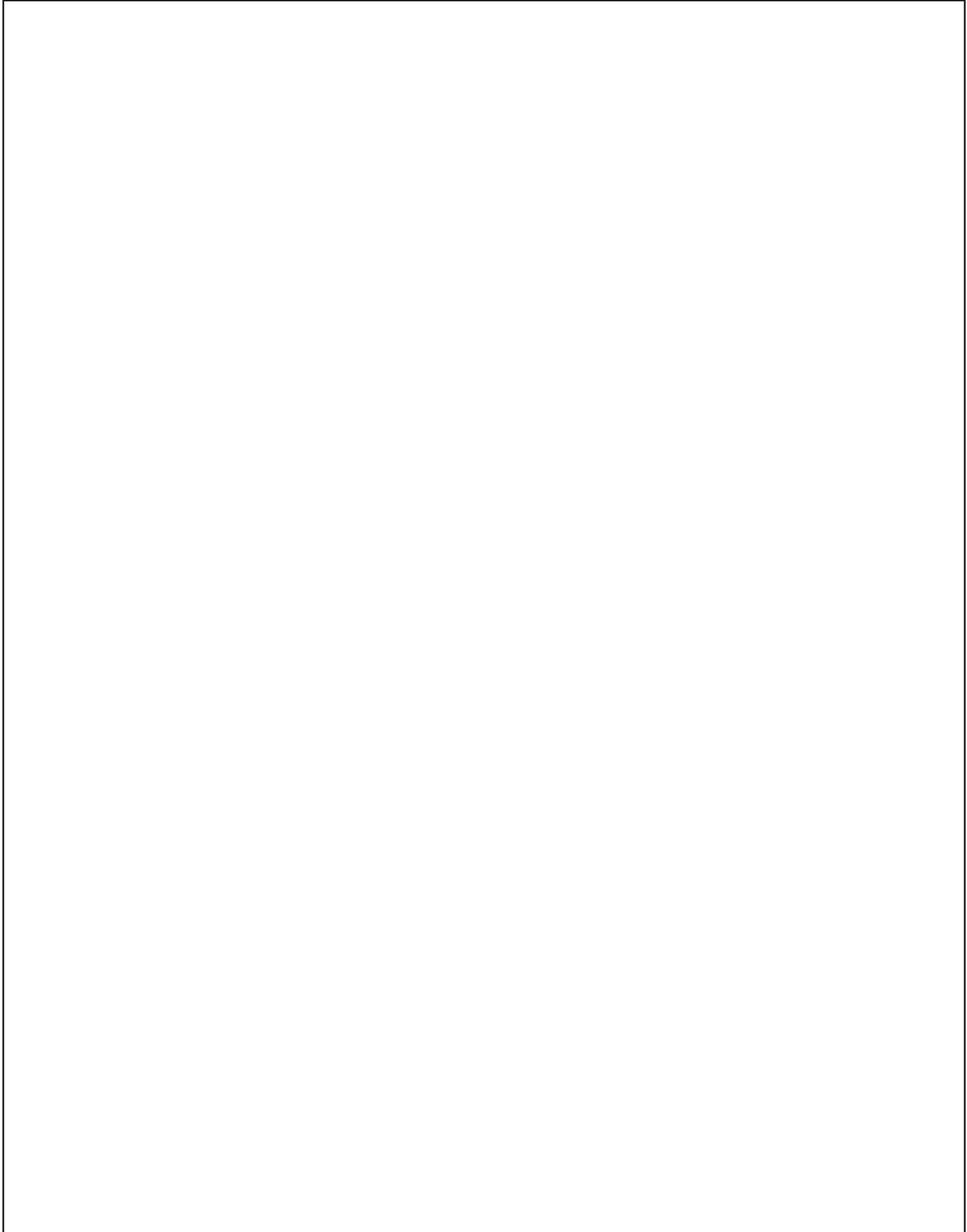

Tall units 2195 mm,
height 03

Tall units 2195 mm,
height 03



Tall units

2195 mm high

Unit without plinth, carcass depth 560 mm

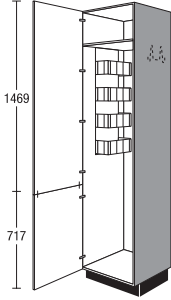
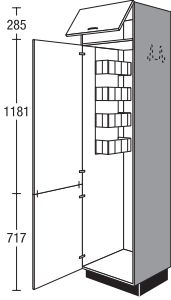
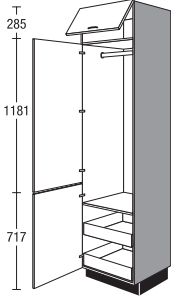
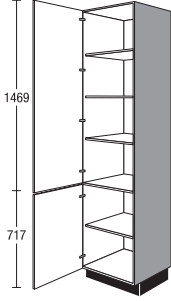
				width	Price group							Servosoft	Pro Servosoft	ProServoglass	Soft closing Top Motion	Soft closing Top Motion Plus					
					1	2	3	4	5	6	7										
	Tall broom cupboard			✓	S	45	03	B	157	169	180	-	-	-	-	-	-	12	12		
	1 hinged door (dowelled)			✓	S	50	03	B	162	177	189	-	-	-	-	-	-	-	12	12	
	1 fixed shelf			✓	S	60	03	B	168	182	194	-	-	-	-	-	-	-	12	12	
	1 wire shelf 1 hook for brooms 1 universal holder for cable, hose and vacuum cleaner accessories stowage of vacuum cleaner, step ladder or ironing board possible																				
<p><i>No wire parts if depth is reduced to less than 410 mm.</i></p> <p><i>Grip ledges are fitted at the works to both side-hung doors in order to achieve a continuous joint pattern.</i></p> <p><i>Available for the following ranges: IP 1200, IP 2200, IP 3150, IP 4050</i></p>																					
	Tall broom cupboard			✓	S	45	03	KB	159	171	182	194	219	240	267	-	-	-	14	24	
	1 flap door			✓	S	50	03	KB	164	179	191	203	227	248	275	-	-	-	14	24	
	1 door (dowelled) 1 wire shelf 1 hook for brooms 1 universal holder for cable, hose and vacuum cleaner accessories stowage of vacuum cleaner, step ladder or ironing board possible			✓	S	60	03	KB	170	184	196	208	234	256	284	-	-	-	14	24	
<p><i>No wire parts if depth is reduced to less than 410 mm.</i></p> <p><i>Grip ledges are fitted at the works to both side-hung doors in order to achieve a continuous joint pattern.</i></p>																					
	Tall unit				S	60	03	KGIS	257	266	278	290	315	338	369	10	16	16	14	24	
1 flap door 1 door (dowelled) 1 garment rail 1 fixed shelf 2 internal drawers																					
<p><i>The hinged doors must open to an angle of at least 90° (observe handle spacing).</i></p> <p><i>Grip ledges are fitted at the works to both side-hung doors in order to achieve a continuous joint pattern.</i></p>																					
	Tall unit			✓	S	30	03		131	142	150	-	-	-	-	-	-	-	12	12	
	1 hinged door			✓	S	45	03		153	167	174	-	-	-	-	-	-	-	-	12	12
	3 adjustable shelves			✓	S	50	03		162	176	182	-	-	-	-	-	-	-	-	12	12
	1 hinged door 1 adjustable shelf			✓	S	60	03		168	181	193	-	-	-	-	-	-	-	-	12	12
<p><i>Available for the following ranges: IP 1200, IP 2200, IP 3150, IP 4050</i></p>																					

Illustrations do not correspond to the door finishes.

Tall units

2195 mm high

Unit without plinth, carcass depth 560 mm

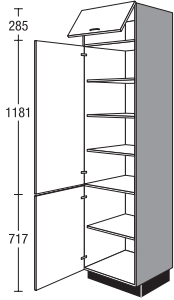
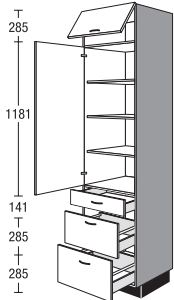
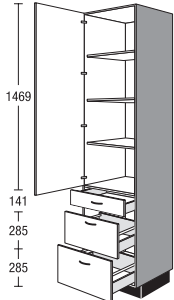
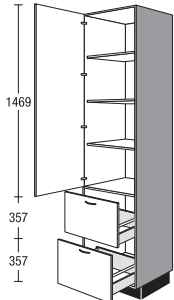
			width	Price group							Servosoft	Pro Servosoft	ProServoGlass	Soft closing Top Motion	Soft closing Top Motion Plus		
				1	2	3	4	5	6	7							
 <p>Tall unit 1 flap door 1 hinged door 3 adjustable shelves 1 hinged door 1 adjustable shelf</p>	<input checked="" type="checkbox"/>	S	30	03	K	133	143	151	159	179	197	219	-	-	-	14	24
	<input checked="" type="checkbox"/>	S	45	03	K	155	168	175	183	216	236	262	-	-	-	14	24
	<input checked="" type="checkbox"/>	S	50	03	K	164	177	183	190	224	245	273	-	-	-	14	24
	<input checked="" type="checkbox"/>	S	60	03	K	170	182	194	206	231	254	282	-	-	-	14	24
 <p>Tall unit 1 flap door 1 hinged door 3 adjustable shelves 1 drawer 2 deep drawers</p>	<input checked="" type="checkbox"/>	SS2A	30	03	K	161	171	179	187	207	225	248	15	24	40	10	20
	<input checked="" type="checkbox"/>	SS2A	45	03	K	179	192	199	207	240	260	287	15	24	40	10	20
	<input checked="" type="checkbox"/>	SS2A	50	03	K	188	201	207	214	248	269	298	15	24	40	10	20
	<input checked="" type="checkbox"/>	SS2A	60	03	K	204	216	228	240	265	288	318	15	24	40	10	20
 <p>Tall unit for crockery 1 hinged door 3 adjustable shelves 1 drawer 2 deep drawers</p> <p><i>Available for the following ranges: IP 1200, IP 2200, IP 3150, IP 4050</i></p>	<input checked="" type="checkbox"/>	NEW	SS2A	30	03	158	168	176	184	204	222	245	15	24	40	8	8
	<input checked="" type="checkbox"/>	NEW	SS2A	45	03	176	189	196	204	237	257	284	15	24	40	8	8
	<input checked="" type="checkbox"/>	NEW	SS2A	50	03	185	198	204	211	245	266	295	15	24	40	8	8
	<input checked="" type="checkbox"/>	NEW	SS2A	60	03	201	213	225	237	262	285	315	15	24	40	8	8
 <p>Tall unit 1 flap door 1 hinged door 3 adjustable shelves 2 deep drawers</p>	<input checked="" type="checkbox"/>	S2A	60	03	K	210	222	233	245	269	291	321	10	16	32	10	20

4.102 Illustrations do not correspond to the door finishes.

Tall units

2195 mm high

Unit without plinth, carcass depth 560 mm

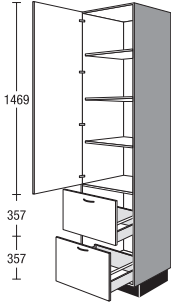
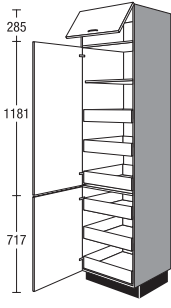
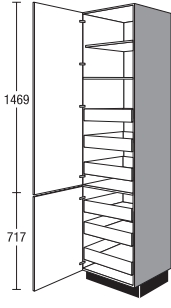
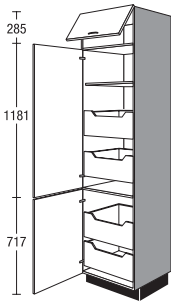
		width		Price group											
		1	2	3	4	5	6	7	Servosoft	Pro Servosoft	ProServoglass	Soft closing Top Motion	Soft closing Top Motion Plus		
 <p>Tall unit</p> <ul style="list-style-type: none"> 1 hinged door 3 adjustable shelves 2 deep drawers <p>Available for the following ranges: IP 1200, IP 2200, IP 3150, IP 4050</p>	NEW	S2A	30	03											
	NEW	S2A	45	03											
	NEW	S2A	50	03											
	NEW	S2A	60	03											
 <p>Tall unit</p> <ul style="list-style-type: none"> 1 flap door 1 hinged door 1 fixed shelf 3 interior drawers 1 hinged door 3 interior drawers <p>The hinged doors must open to an angle of at least 90° (observe handle spacing). Door must not be hinged on side adjacent to the worktop.</p>		S	30	03	KIS										
		S	45	03	KIS										
		S	50	03	KIS										
		S	60	03	KIS										
 <p>Tall unit</p> <ul style="list-style-type: none"> 1 hinged door 1 adjustable shelf 1 fixed shelf 3 interior drawers 1 hinged door 3 interior drawers <p>The hinged doors must open to an angle of at least 90° (observe handle spacing). Door must not be hinged on side adjacent to the worktop.</p> <p>Available for the following ranges: IP 1200, IP 2200, IP 3150, IP 4050</p>	NEW	S	30	03	IS										
	NEW	S	45	03	IS										
	NEW	S	50	03	IS										
	NEW	S	60	03	IS										
 <p>Tall unit</p> <ul style="list-style-type: none"> 1 flap door 1 hinged door 1 fixed shelf 2 interior deep drawers 1 hinged door 2 interior deep drawers <p>The hinged doors must open to an angle of at least 90° (observe handle spacing). Door must not be hinged on side adjacent to the worktop.</p>		S	30	03	KIA										
		S	45	03	KIA										
		S	50	03	KIA										
		S	60	03	KIA										

Illustrations do not correspond to the door finishes.

Tall units

2195 mm high

Unit without plinth, carcass depth 560 mm

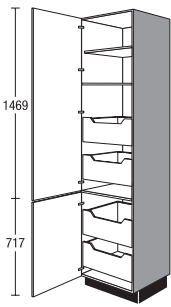
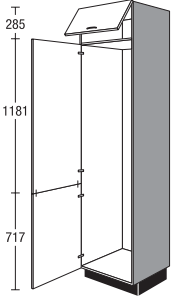
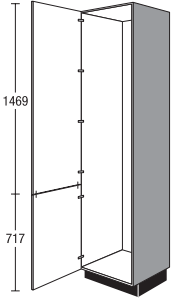
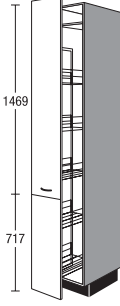
			width	Price group							Servosoft	Pro Servosoft	ProServoGlass	Soft closing Top Motion	Soft closing Top Motion Plus		
				1	2	3	4	5	6	7							
 <p>Tall unit</p> <p>1 hinged door 1 adjustable shelf 1 fixed shelf 2 interior deep drawers 1 hinged door 2 interior deep drawers</p> <p><i>The hinged doors must open to an angle of at least 90° (observe handle spacing). Door must not be hinged on side adjacent to the worktop.</i></p> <p><i>Available for the following ranges: IP 1200, IP 2200, IP 3150, IP 4050</i></p>	NEW	S	30	03	IA	214	228	240	253	281	308	340	20	32	64	12	12
	NEW	S	45	03	IA	239	258	268	280	328	357	396	20	32	64	12	12
	NEW	S	50	03	IA	251	269	278	289	337	367	407	20	32	64	12	12
	NEW	S	60	03	IA	265	282	300	317	353	386	428	20	32	64	12	12
 <p>Tall unit for individual equipping</p> <p>1 flap door 1 door (dowelled)</p> <p><i>Grip ledges are fitted at the works to both side-hung doors in order to achieve a continuous joint pattern.</i></p>		S	60	03	KZ	165	176	188	200	226	248	276	-	-	-	14	24
 <p>Tall unit for individual equipping</p> <p>1 door (dowelled)</p> <p><i>Grip ledges are fitted at the works to both side-hung doors in order to achieve a continuous joint pattern.</i></p> <p><i>Available for the following ranges: IP 1200, IP 2200, IP 3150, IP 4050</i></p>	NEW	S	60	03	Z	160	171	182	194	219	240	268	-	-	-	12	12
 <p>Pull-out tall unit with wire baskets, silver grey</p> <p>1 full-extension pull-out with cushioning consisting of 2 fronts 1 fixed shelf 5 adjustable baskets</p> <p><i>Handle only fitted horizontally</i></p> <p><i>Grip ledges are fitted at the works to both fronts in order to achieve a continuous joint pattern.</i></p> <p><i>Runner profile top and bottom Baskets can be used from both sides.</i></p> <p><i>Available for the following ranges: IP 1200, IP 2200, IP 3150, IP 4050</i></p>		SA	30	03		268	288	292	-	-	-	-	-	-	-	-	-

4.104 Illustrations do not correspond to the door finishes.

Tall units

2195 mm high

Unit without plinth, carcass depth 560 mm

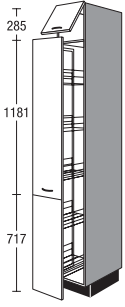
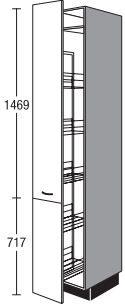
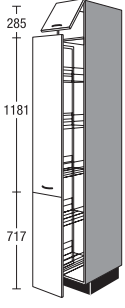
		width	Price group							Servosoft	Pro Servosoft	ProServoglass	Soft closing Top Motion	Soft closing Top Motion Plus		
			1	2	3	4	5	6	7							
 <p>Pull-out tall unit with wire baskets, silver grey</p> <p>1 flap door 1 full-extension pull-out with cushioning consisting of 2 fronts 5 adjustable baskets</p> <p><i>Handle only fitted horizontally</i></p> <p><i>Grip ledges are fitted at the works to both fronts in order to achieve a continuous joint pattern.</i></p> <p><i>Runner profile top and bottom</i></p>	SA	30	03	K	280	301	305	309	327	335	353	36	36	36	4	14
 <p>Pull-out tall unit Baskets with wooden shelf and metal rail</p> <p>1 full-extension pull-out with cushioning consisting of 2 fronts 1 fixed shelf 5 adjustable baskets</p> <p><i>Handle only fitted horizontally</i></p> <p><i>Grip ledges are fitted at the works to both fronts in order to achieve a continuous joint pattern.</i></p> <p><i>Runner profile top and bottom Baskets can be used from both sides.</i></p> <p><i>Available for the following ranges: IP 1200, IP 2200, IP 3150, IP 4050</i></p>	SA	30	03	P	372	392	396	-	-	-	-	-	-	-	-	-
 <p>Pull-out tall unit Baskets with wooden shelf and metal rail</p> <p>1 flap door 1 full-extension pull-out with cushioning consisting of 2 fronts 5 adjustable baskets</p> <p><i>Handle only fitted horizontally</i></p> <p><i>Grip ledges are fitted at the works to both fronts in order to achieve a continuous joint pattern.</i></p> <p><i>Runner profile top and bottom Baskets can be used from both sides.</i></p> <p>Suitable additions:</p> <p>Hanging basket Wooden shelf with metal rail</p>	SA	30	03	KP	385	406	410	414	432	440	462	-	-	-	4	14
	ZIK	30	P		7	7	7	7	7	7	7	7	-	-	-	-

Illustrations do not correspond to the door finishes.

4.105

Tall units

2195 mm high

Unit without plinth, carcass depth 560 mm

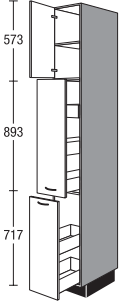
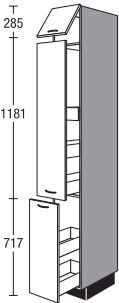
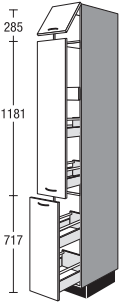
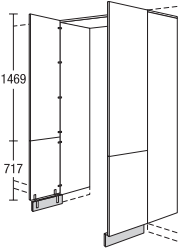
						Price group											
				width		1	2	3	4	5	6	7	Servosoft	Pro Servosoft	ProServoGlass	Soft closing Top Motion	Soft closing Top Motion Plus
 <p>Tall unit <input checked="" type="checkbox"/></p> <p>1 hinged door 1 adjustable shelf 1 deep drawer with 2 drawers 1 internal drawer 1 deep drawer with 2 drawers</p> <p><i>Handle only fitted horizontally</i></p> <p><i>The front panel must be removed to fit handles on ranges IP 4250, IP 7810 CK, IP 7820 CK.</i></p>	SA	30	03	S	213	230	232	237	244	256	275	25	40	40	4	4	
	 <p>Tall unit <input checked="" type="checkbox"/></p> <p>1 flap door 1 deep drawer with 2 drawers 1 internal drawer 1 deep drawer with 2 drawers</p> <p><i>Handle only fitted horizontally</i></p> <p><i>The front panel must be removed to fit handles on ranges IP 4250, IP 7810 CK, IP 7820 CK.</i></p>	SA	30	03	KS	217	234	236	240	246	258	278	25	40	40	4	14
 <p>Tall unit <input checked="" type="checkbox"/> <small>NEW</small></p> <p>1 flap door 1 Auszug mit 2 Auszügen 1 internal drawer 1 Auszug mit 2 Auszügen</p> <p><i>Handle only fitted horizontally</i></p> <p><i>The front panel must be removed to fit handles on ranges IP 4250, IP 7810 CK, IP 7820 CK.</i></p>	SA	30	03	KA	229	246	248	252	258	270	290	25	40	72	4	14	
 <p>Access door</p> <p>2 doors (dowelled) 2 end panels, 16 mm thick, same colour and height as carcass 1 top panel, 16 mm thick, same colour as carcass 2 plinth panels in same colour as carcass, including connecting angle</p> <p><i>Available for the following ranges: IP 1200, IP 2200, IP 3150, IP 4050</i></p> <p><i>Not available in the following plinth decor: 299 Stainless steel effect</i></p> <p><i>Only plan between 2 tall units in height 03.</i></p> <p><i>The delivery comprises several packages.</i></p>	DG	90	03		215	230	245	-	-	-	-	-	-	-	20	20	
	DG	100	03		220	236	251	-	-	-	-	-	-	-	-	20	20

Tall units

2195 mm high

Unit without plinth, carcass depth 560 mm

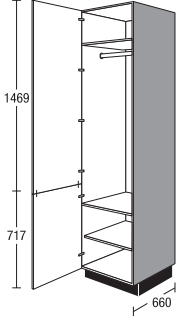
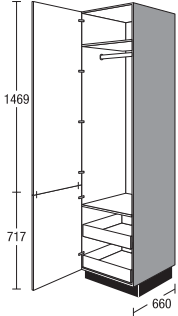
				width	Price group							Servosoft	Pro Servosoft	ProServoglass	Soft closing Top Motion	Soft closing Top Motion Plus
					1	2	3	4	5	6	7					
 <p>Tall unit with clothes rail NEW</p> <p>Carcass depth 660 mm</p> <p>1 door (dowelled) 1 garment rail 1 fixed shelf 1 adjustable shelf</p> <p><i>Grip ledges are fitted at the works to both side-hung doors in order to achieve a continuous joint pattern.</i></p> <p><i>Available for the following ranges: IP 1200, IP 2200, IP 3150, IP 4050</i></p>	S	45	03	66G1	195	213	222	236	259	281	310	-	-	-	12	12
	S	50	03	66G1	204	222	229	247	271	295	324	-	-	-	12	12
	S	60	03	66G1	224	241	257	272	304	333	369	-	-	-	12	12
 <p>Tall unit with clothes rail NEW</p> <p>Carcass depth 660 mm</p> <p>1 hinged door (dowelled) 1 garment rail 1 fixed shelf 2 internal drawers</p> <p><i>Grip ledges are fitted at the works to both side-hung doors in order to achieve a continuous joint pattern.</i></p> <p><i>Available for the following ranges: IP 1200, IP 2200, IP 3150, IP 4050</i></p>	S	45	03	66GIS	249	271	284	298	330	353	383	-	-	-	12	12
	S	50	03	66GIS	258	280	294	308	339	363	394	-	-	-	12	12
	S	60	03	66GIS	278	288	301	314	341	366	399	-	-	-	12	12

Illustrations do not correspond to the door finishes.

Diagonal tall units

2195 mm high

Unit without plinth, carcass depth 560 mm

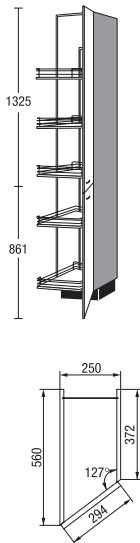
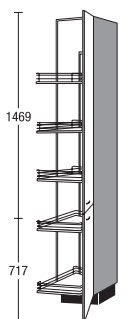
				width	Price group							Servosoft	Pro Servosoft	ProServoGlass	Soft closing Top Motion	Soft closing Top Motion Plus
					1	2	3	4	5	6	7					
 <p>3-D tall unit 560/372 mm deep 1 hinged door (dowelled) 1 basket trolley with 5 adjustable baskets</p> <p><i>Grip ledges are fitted at the works to both side-hung doors in order to achieve a continuous joint pattern.</i></p> <p>Suitable additions:</p> <p>Hanging basket silver-grey</p>	SV	25	03	T2	413	438	442	447	468	477	502	-	-	-	-	-
		ZIK 25 T				11	11	11	11	11	11	11	-	-	-	-
 <p>3-D tall unit <small>NEW</small> 560/372 mm deep 1 hinged door 1 basket trolley with 5 adjustable baskets</p> <p><i>Grip ledges are fitted at the works to both side-hung doors in order to achieve a continuous joint pattern.</i></p> <p><i>Available for the following ranges: IP 1200, IP 2200, IP 3150, IP 4050</i></p> <p>Suitable additions:</p> <p>Hanging basket silver-grey</p>	SV	25	03	T	413	438	442	447	468	477	502	-	-	-	-	-
		ZIK 25 T				11	11	11	11	11	11	11	-	-	-	-

4.108 Illustrations do not correspond to the door finishes.

Appliance housings with niche height 880 mm

2195 mm high

Unit without plinth, carcass depth 560 mm

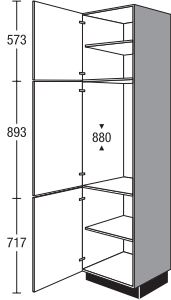
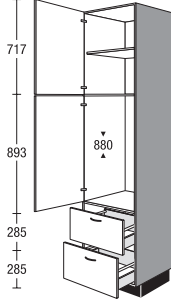
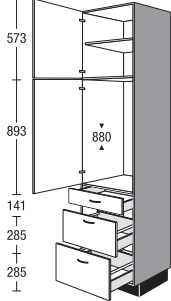
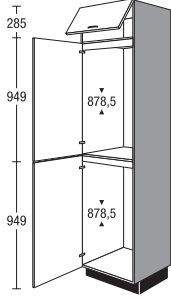
	width	Price group							Servosoft	Pro Servosoft	ProServoglass	Soft closing Top Motion	Soft closing Top Motion Plus	
		1	2	3	4	5	6	7						
 <p>Tall unit for appliances Niche height 880 mm</p> <ul style="list-style-type: none"> 1 hinged door 1 adjustable shelf 1 appliance door 1 hinged door 1 adjustable shelf <p><i>For cladding up to the ceiling, provision must be made for a ventilation opening of min. 200 cm² in diameter.</i></p> <p>G88 03 SIA</p>	G88	03	166	180	194	209	243	272	308	-	-	-	12	12
 <p>Tall unit for appliances Niche height 880 mm</p> <ul style="list-style-type: none"> 1 hinged door 1 adjustable shelf 1 appliance door 2 deep drawers <p><i>For cladding up to the ceiling, provision must be made for a ventilation opening of min. 200 cm² in diameter.</i></p> <p>G882A 03 XSIA</p>	G882A	03 X	206	218	232	246	272	299	333	10	16	32	8	8
 <p>Tall unit for appliances Niche height 880 mm</p> <ul style="list-style-type: none"> 1 hinged door 1 adjustable shelf 1 appliance door 1 drawer 2 deep drawers <p><i>For cladding up to the ceiling, provision must be made for a ventilation opening of min. 200 cm² in diameter.</i></p> <p>G88S2A 03 SIA</p>	G88S2A	03	241	255	271	288	318	350	389	15	24	40	8	8
 <p>Tall unit for appliances Recess height 878.5 mm Recess height 878.5 mm</p> <ul style="list-style-type: none"> 1 flap door 2 hinged appliance doors <p><i>niche size adjustment partially with infill panels.</i></p> <p><i>For cladding up to the ceiling, provision must be made for a ventilation opening of min. 200 cm² in diameter.</i></p> <p>G8888 03 K4STB</p>	G8888	03 K4	168	183	195	207	231	253	281	-	-	-	16	26

Illustrations do not correspond to the door finishes.

Appliance housings with niche height 880 mm, Appliance housings with niche height 1025 mm

2195 mm high

Unit without plinth, carcass depth 560 mm

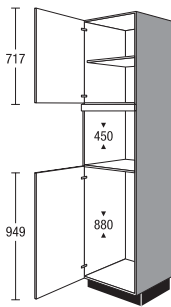
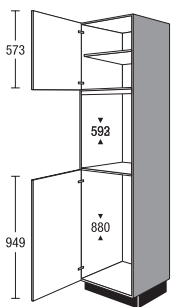
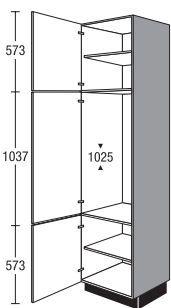
	width	Price group							Servosoft	Pro Servosoft	ProServoGlass	Soft closing Top Motion	Soft closing Top Motion Plus		
		1	2	3	4	5	6	7							
 <p>Tall unit for appliances Niche height 450 mm Niche height 880 mm 1 hinged door 1 adjustable shelf 1 appliance door One front panel per appliance type will be provided for adaptation on site. Recess sizes are adjusted in part through the use of carcass panels. Version supplied may deviate from the illustration according to appliance type. For cladding up to the ceiling, provision must be made for a ventilation opening of min. 200 cm² in diameter.</p> <p>G88M 03 4SOA</p>	G88M	03	4	175	187	193	200	229	250	275	-	-	-	10	10
 <p>Tall unit for appliances Niche height 593 mm Niche height 880 mm 1 hinged door 1 adjustable shelf 1 appliance door One front panel per appliance type will be provided for adaptation on site. Recess sizes are adjusted in part through the use of carcass panels. Version supplied may deviate from the illustration according to appliance type. For cladding up to the ceiling, provision must be made for a ventilation opening of min. 200 cm² in diameter. For foil-wrapped fronts a set of heat deflector plates are supplied free of charge.</p> <p>G88B 03 4SPF</p>	G88B	03	4	192	205	212	220	251	275	302	-	-	-	10	10
 <p>Tall unit for appliances niche height 1025 mm 1 hinged door 1 adjustable shelf 1 hinged appliance door 1 hinged door 1 adjustable shelf For cladding up to the ceiling, provision must be made for a ventilation opening of min. 200 cm² in diameter.</p> <p>G102 03 XSLLC</p>	G102	03	X	172	185	195	205	241	260	282	-	-	-	14	14

4.110 Illustrations do not correspond to the door finishes.

Appliance housings with niche height 1025 mm, Appliance housings with niche height 1225 mm

2195 mm high

Unit without plinth, carcass depth 560 mm

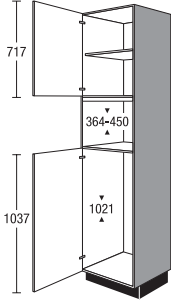
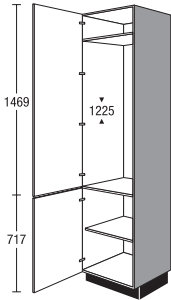
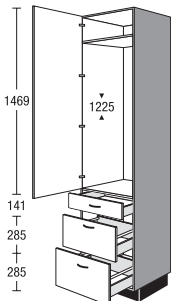
	width	Price group							Servosoft	Pro Servosoft	ProServoglass	Soft closing Top Motion	Soft closing Top Motion Plus		
		1	2	3	4	5	6	7							
 <p>Tall unit for appliances Recess height 365 - 450 mm niche height 1021 mm</p> <p>1 hinged door 1 adjustable shelf 1 appliance door</p> <p><i>One front panel per appliance type will be provided for adaptation on site.</i></p> <p><i>Version supplied may deviate from the illustration according to appliance type.</i></p> <p><i>For cladding up to the ceiling, provision must be made for a ventilation opening of min. 200 cm² in diameter.</i></p> <p><i>Depending on type with metal plinth shelf.</i></p> <p>G102M 03 5SPC</p>	G102M	03	5	208	222	236	251	268	290	317	-	-	-	10	10
 <p>Tall unit for appliances niche height 1225 mm</p> <p>1 appliance door 1 fixed shelf 1 hinged door 1 adjustable shelf</p> <p><i>niche size adjustment partially with infill panels.</i></p> <p><i>Version supplied may deviate from the illustration according to appliance type.</i></p> <p><i>For cladding up to the ceiling, provision must be made for a ventilation opening of min. 200 cm² in diameter.</i></p> <p><i>Available for the following ranges: IP 1200, IP 2200, IP 3150, IP 4050</i></p> <p>G122 03 SNL</p>	G122	03		170	184	199	-	-	-	-	-	-	-	12	12
 <p>Tall unit for appliances niche height 1225 mm</p> <p>1 appliance door 1 fixed shelf 1 drawer 2 deep drawers</p> <p><i>niche size adjustment partially with infill panels.</i></p> <p><i>Version supplied may deviate from the illustration according to appliance type.</i></p> <p><i>For cladding up to the ceiling, provision must be made for a ventilation opening of min. 200 cm² in diameter.</i></p> <p><i>Available for the following ranges: IP 1200, IP 2200, IP 3150, IP 4050</i></p> <p>G122S2A 03 SNL</p>	G122S2A	03		203	215	227	-	-	-	-	15	24	40	8	20

Illustrations do not correspond to the door finishes.

4.111

Appliance housings with niche height 1225 mm

2195 mm high

Unit without plinth, carcass depth 560 mm

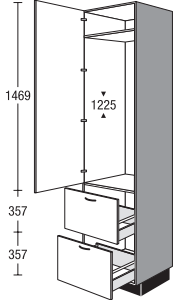
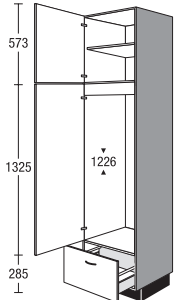
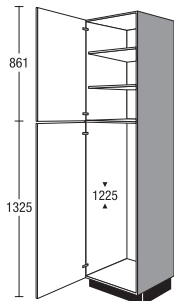
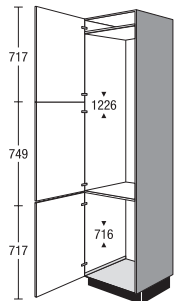
	width	Price group							Servosoft	Pro Servosoft	ProServoGlass	Soft closing Top Motion	Soft closing Top Motion Plus	
		1	2	3	4	5	6	7						
 <p>Tall unit for appliances niche height 1225 mm</p> <p>1 appliance door 1 fixed shelf 2 deep drawers</p> <p><i>niche size adjustment partially with infill panels.</i></p> <p><i>Version supplied may deviate from the illustration according to appliance type.</i></p> <p><i>For cladding up to the ceiling, provision must be made for a ventilation opening of min. 200 cm² in diameter.</i></p> <p><i>Available for the following ranges: IP 1200, IP 2200, IP 3150, IP 4050</i></p> <p>G1222A 03 SNL</p>	G1222A	03	209	221	232	-	-	-	-	10	16	32	8	20
 <p>Tall unit for appliances Niche height 1226 mm</p> <p>1 hinged door 1 adjustable shelf 1 appliance door 1 deep drawer</p> <p><i>niche size adjustment partially with infill panels.</i></p> <p><i>For cladding up to the ceiling, provision must be made for a ventilation opening of min. 200 cm² in diameter.</i></p> <p><i>For ergonomic reasons, the hinged door for appliances is split when handle strips and recessed grips are planned.</i> <i>Front dimension bottom: 429 mm, top: 893 mm</i></p> <p>G122A 03 SNL</p>	G122A	03	202	219	234	250	284	306	333	5	8	16	10	10
 <p>Tall unit for appliances niche height 1225 mm</p> <p>1 hinged door 2 adjustable shelves 1 appliance door</p> <p><i>niche size adjustment partially with infill panels.</i></p> <p><i>Version supplied may deviate from the illustration according to appliance type.</i></p> <p><i>For cladding up to the ceiling, provision must be made for a ventilation opening of min. 200 cm² in diameter.</i></p> <p>G122 03 9SNL</p>	G122	03 9	171	185	200	216	250	272	300	-	-	-	10	10
 <p>Tall unit for appliances Niche height 1226 mm Recess height 716 mm</p> <p>1 hinged appliance door (pinned) 1 appliance door</p> <p><i>niche size adjustment partially with infill panels.</i></p> <p><i>Version supplied may deviate from the illustration according to appliance type.</i></p> <p><i>For cladding up to the ceiling, provision must be made for a ventilation opening of min. 200 cm² in diameter.</i></p> <p>G12272 03 SVF</p>	G12272	03	208	227	242	257	287	316	351	-	-	-	12	12

4.112 Illustrations do not correspond to the door finishes.

Appliance housings with niche height 1400 mm, Appliance housings with niche height 1445 mm

2195 mm high

Unit without plinth, carcass depth 560 mm

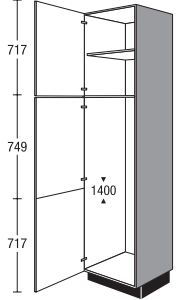
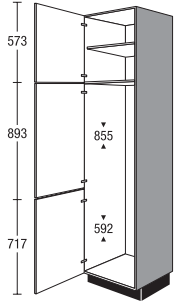
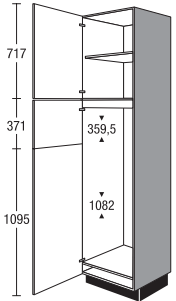
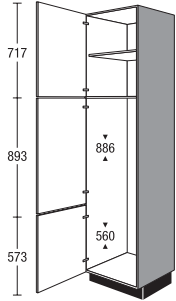
	width	Price group							Servosoft	Pro Servosoft	ProServoglass	Soft closing Top Motion	Soft closing Top Motion Plus		
		1	2	3	4	5	6	7							
 <p>Tall unit for appliances Niche height 1400 mm</p> <p>1 hinged door 1 adjustable shelf 1 hinged appliance door (pinned)</p> <p><i>niche size adjustment partially with infill panels.</i></p> <p><i>Version supplied may deviate from the illustration according to appliance type.</i></p> <p><i>Grip ledges are fitted to all appliance side-hung doors at the works in order to achieve a continuous joint pattern.</i></p> <p><i>For cladding up to the ceiling, provision must be made for a ventilation opening of min. 200 cm² in diameter.</i></p> <p>G140 03 SPA</p>	G140	03	165	178	193	209	241	263	290	-	-	-	12	12	
 <p>Tall unit for appliances Recess height 855 mm Niche height 592 mm</p> <p>1 hinged door 1 adjustable shelf 2 hinged appliance doors</p> <p><i>niche size adjustment partially with infill panels.</i></p> <p><i>Version supplied may deviate from the illustration according to appliance type.</i></p> <p><i>For cladding up to the ceiling, provision must be made for a ventilation opening of min. 200 cm² in diameter.</i></p> <p>G145 03 SPE</p>	G145	03	167	180	196	211	244	266	293	-	-	-	12	12	
 <p>Tall unit for appliances Recess height 359.5 mm Recess height 1082 mm</p> <p>1 hinged door 1 adjustable shelf 2 hinged appliance doors</p> <p><i>niche size adjustment partially with infill panels.</i></p> <p><i>Version supplied may deviate from the illustration according to appliance type.</i></p> <p><i>For cladding up to the ceiling, provision must be made for a ventilation opening of min. 200 cm² in diameter.</i></p> <p>G145 03 6SPK</p>	G145	03	6	161	174	189	204	235	256	282	-	-	-	14	14
 <p>Tall unit for appliances Recess height 886 mm Recess height 560 mm</p> <p>1 hinged door 1 adjustable shelf 2 hinged appliance doors</p> <p><i>niche size adjustment partially with infill panels.</i></p> <p><i>Version supplied may deviate from the illustration according to appliance type.</i></p> <p><i>For cladding up to the ceiling, provision must be made for a ventilation opening of min. 200 cm² in diameter.</i></p> <p>G145 03 XSPM</p>	G145	03	X	159	172	186	201	232	253	279	-	-	-	12	12

Illustrations do not correspond to the door finishes.

Appliance housings with niche height 1580 mm, Appliance housings with niche height 1780 mm

2195 mm high

Unit without plinth, carcass depth 560 mm

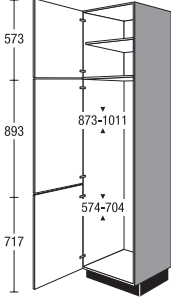
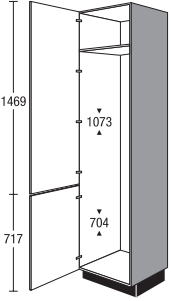
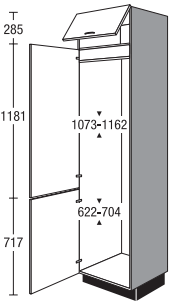
	width	Price group							Servosoft	Pro Servosoft	ProServoGlass	Soft closing Top Motion	Soft closing Top Motion Plus	
		1	2	3	4	5	6	7						
 <p>Tall unit for appliances Recess height 873 - 1011 mm Recess height 574 - 704 mm 1 hinged door 1 adjustable shelf 2 hinged appliance doors for opening together or separately, according to finish and type of appliance <i>niche size adjustment partially with infill panels.</i> <i>Version supplied may deviate from the illustration according to appliance type.</i> Grip ledges are fitted at the works to both appliance doors that open together in order to achieve a continuous joint pattern. For cladding up to the ceiling, provision must be made for a ventilation opening of min. 200 cm² in diameter.</p> <p>G158 03 SRT</p>	G158	03	163	176	191	206	238	259	285	-	-	-	12	12
 <p>Tall unit for appliances Recess height 1073 mm niche height 704 mm 1-2 hinged appliance doors for opening together or separately, according to finish and type of appliance 1 fixed shelf <i>niche size adjustment partially with infill panels.</i> <i>Version supplied may deviate from the illustration according to appliance type.</i> For cladding up to the ceiling, provision must be made for a ventilation opening of min. 200 cm² in diameter. Available for the following ranges: IP 1200, IP 2200, IP 3150, IP 4050</p> <p>G178 03 STD</p>	G178	03	170	187	197	-	-	-	-	-	-	-	12	12
 <p>Tall unit for appliances Recess height 1073 - 1162 mm Recess height 622 - 704 mm 1 flap door 2 hinged appliance doors <i>niche size adjustment partially with infill panels.</i> <i>Version supplied may deviate from the illustration according to appliance type.</i> For cladding up to the ceiling, provision must be made for a ventilation opening of min. 200 cm² in diameter.</p> <p>G178 03 KSTD</p>	G178	03 K	166	182	192	204	233	261	295	-	-	-	14	24

4.114 Illustrations do not correspond to the door finishes.

Appliance housings with aperture height 1890, 1940, 380, 450 mm

2195 mm high

Unit without plinth, carcass depth 560 mm

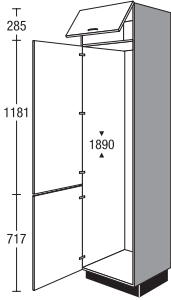
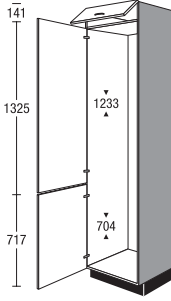
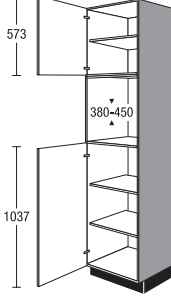
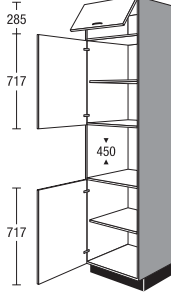
	width	Price group							Servosoft	Pro Servosoft	ProServodglass	Soft closing Top Motion	Soft closing Top Motion Plus		
		1	2	3	4	5	6	7							
 <p>Tall unit for appliances Recess height 1890 mm</p> <p>1 flap door 2 hinged appliance doors for opening together or separately, according to finish and type of appliance</p> <p><i>niche size adjustment partially with infill panels.</i></p> <p><i>Version supplied may deviate from the illustration according to appliance type.</i></p> <p><i>For cladding up to the ceiling, provision must be made for a ventilation opening of min. 200 cm² in diameter.</i></p> <p>G189 03 KSUH</p>	G189	03	K	190	208	220	234	267	299	338	-	-	-	14	24
 <p>Tall unit for appliances Recess height 1233 mm niche height 704 mm</p> <p>1 flap door 2 hinged appliance doors</p> <p><i>niche size adjustment partially with infill panels.</i></p> <p><i>Version supplied may deviate from the illustration according to appliance type.</i></p> <p><i>For cladding up to the ceiling, provision must be made for a ventilation opening of min. 200 cm² in diameter.</i></p> <p>G194 03 KSVE</p>	G194	03	K	170	186	197	209	239	267	301	-	-	-	12	22
 <p>Tall unit for appliances Recess height 380 - 450 mm</p> <p>1 hinged door 1 adjustable shelf 1 hinged door 2 adjustable shelves</p> <p><i>One front panel per appliance type will be provided for adaptation on site.</i></p> <p><i>Recess sizes are adjusted in part through the use of carcass panels.</i></p> <p><i>For cladding up to the ceiling, provision must be made for a ventilation opening of min. 200 cm² in diameter.</i></p> <p>GM 03 5DF</p>	GM	03	5	220	237	252	268	286	311	341	-	-	-	10	10
 <p>Tall unit for appliances Niche height 450 mm</p> <p>1 flap door 1 hinged door 1 adjustable shelf 1 hinged door 1 adjustable shelf</p> <p><i>For cladding up to the ceiling, provision must be made for a ventilation opening of min. 200 cm² in diameter.</i></p> <p>GM 03 KEE</p>	GM	03	K	172	184	195	207	228	242	260	-	-	-	12	22

Illustrations do not correspond to the door finishes.

4.115

Appliance housings with niche height 450 mm, Appliance housings with niche height 590 mm

2195 mm high

Unit without plinth, carcass depth 560 mm

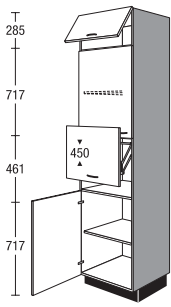
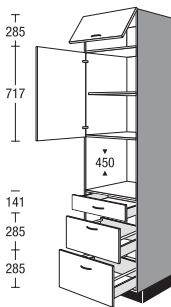
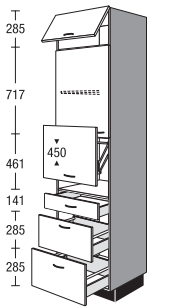
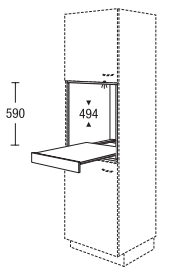
	width	Price group							Servosoft	Pro Servosoft	ProServoGlass	Soft closing Top Motion	Soft closing Top Motion Plus		
		1	2	3	4	5	6	7							
 <p>Tall unit for appliances with lift-up door Niche height 450 mm same as above, but plus 1 lift-up door Maximum size of stand-alone Height 400 mm Width 510 mm Depth: 540 430 mm opening height for lift-up door</p> <p>GM 03 KL</p>	GM	03	KL	242	259	275	291	321	341	366	-	-	-	12	22
 <p>Tall unit for appliances Niche height 450 mm 1 flap door 1 hinged door 1 adjustable shelf 1 drawer 2 deep drawers <i>For cladding up to the ceiling, provision must be made for a ventilation opening of min. 200 cm² in diameter.</i></p> <p>GMS2A 03 KEE</p>	GMS2A	03	K	241	259	276	291	319	350	383	15	24	40	8	18
 <p>Tall unit for appliances with lift-up door Niche height 450 mm same as above, but plus 1 lift-up door Maximum size of stand-alone Height 400 mm Width 510 mm Depth: 540 430 mm opening height for lift-up door</p> <p>GMS2A 03 KL</p>	GMS2A	03	KL	311	334	356	376	412	452	495	15	24	40	8	18
 <p>Modular built in shelf unit for highboard / tall unit for niche heights 590 mm Depth: 505 mm 1 pull-out shelf <i>Finish in carcass material</i> <i>Not available in visible side colours.</i></p>	MR	60	59	TA	201	201	201	201	201	201	-	-	-	-	-

4.116 Illustrations do not correspond to the door finishes.

Appliance housings with niche height 590 mm

2195 mm high

Unit without plinth, carcass depth 560 mm

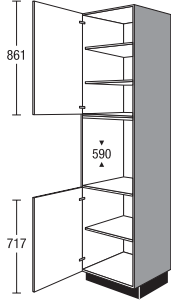
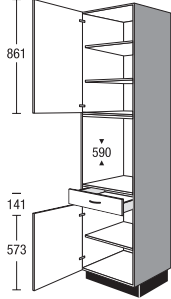
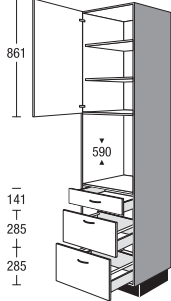
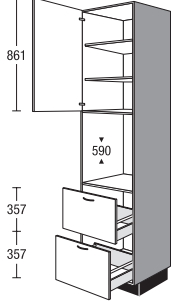
	width	Price group							Servosoft	Pro Servosoft	ProServoglass	Soft closing Top Motion	Soft closing Top Motion Plus	
		1	2	3	4	5	6	7						
 <p>Tall unit for appliances niche height 590 mm</p> <ul style="list-style-type: none"> 1 hinged door 2 adjustable shelves 1 hinged door 1 adjustable shelf <p><i>For cladding up to the ceiling, provision must be made for a ventilation opening of min. 200 cm² in diameter.</i></p> <p><i>For foil-wrapped fronts a set of heat deflector plates are supplied free of charge.</i></p> <p>GB 03 FB</p>	GB	03	159	170	181	192	212	225	242	-	-	-	8	8
 <p>Tall unit for appliances niche height 590 mm</p> <ul style="list-style-type: none"> 1 hinged door 2 adjustable shelves 1 drawer 1 hinged door 1 adjustable shelf <p><i>For cladding up to the ceiling, provision must be made for a ventilation opening of min. 200 cm² in diameter.</i></p> <p><i>For foil-wrapped fronts a set of heat deflector plates are supplied free of charge.</i></p> <p>GBS 03 FB</p>	GBS	03	184	196	209	222	245	260	279	5	8	8	8	8
 <p>Tall unit for appliances niche height 590 mm</p> <ul style="list-style-type: none"> 1 hinged door 2 adjustable shelves 1 drawer 2 deep drawers <p><i>For cladding up to the ceiling, provision must be made for a ventilation opening of min. 200 cm² in diameter.</i></p> <p><i>For foil-wrapped fronts a set of heat deflector plates are supplied free of charge.</i></p> <p>GBS2A 03 FB</p>	GBS2A	03	242	260	277	293	321	352	385	15	24	40	4	4
 <p>Tall unit for appliances niche height 590 mm</p> <ul style="list-style-type: none"> 1 hinged door 2 adjustable shelves 2 deep drawers <p><i>For cladding up to the ceiling, provision must be made for a ventilation opening of min. 200 cm² in diameter.</i></p> <p><i>For foil-wrapped fronts a set of heat deflector plates are supplied free of charge.</i></p> <p>GB2A 03 FB</p>	GB2A	03	217	240	254	267	290	315	344	10	16	32	4	4

Illustrations do not correspond to the door finishes.

Appliance housings with niche height 590 mm

2195 mm high

Unit without plinth, carcass depth 560 mm

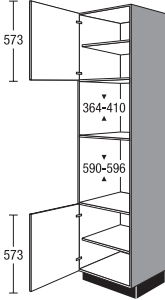
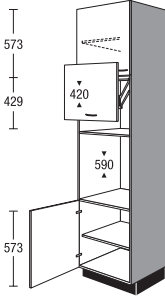
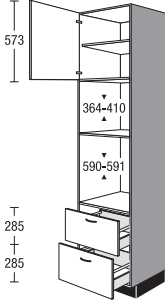
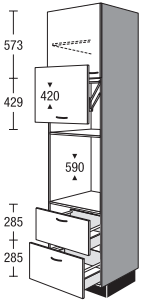
		width	Price group							Servosoft	Pro Servosoft	ProServoGlass	Soft closing Top Motion	Soft closing Top Motion Plus	
			1	2	3	4	5	6	7						
 <p>Tall unit for appliances Recess height 364 - 410 mm Recess height 590 - 596 mm 1 hinged door 1 adjustable shelf 1 hinged door 1 adjustable shelf <i>One front panel per appliance type will be provided for adaptation on site.</i> <i>For cladding up to the ceiling, provision must be made for a ventilation opening of min. 200 cm² in diameter.</i> For foil-wrapped fronts a set of heat deflector plates are supplied free of charge.</p> <p>GMB 03 XLA</p>	GMB	03	X	169	190	201	212	227	250	276	-	-	-	8	8
	 <p>Tall unit for appliances with lift-up door Recess height 420 mm niche height 590 mm same as above, but plus 1 lift-up door Maximum size of stand-alone Height 400 mm Width 510 mm Depth: 540 430 mm opening height for lift-up door</p> <p>GMB 03 LXFB</p>	GMB	03	LX	234	264	280	295	317	350	387	-	-	-	8
 <p>Tall unit for appliances Recess height 364 - 410 mm Recess height 590 - 591 mm 1 hinged door 1 adjustable shelf 2 deep drawers <i>One front panel per appliance type will be provided for adaptation on site.</i> <i>For cladding up to the ceiling, provision must be made for a ventilation opening of min. 200 cm² in diameter.</i> For foil-wrapped fronts a set of heat deflector plates are supplied free of charge.</p> <p>GMB2A 03 XLA</p>		GMB2A	03	X	209	231	242	253	268	293	320	10	16	32	4
	 <p>Tall unit for appliances with lift-up door Recess height 420 mm niche height 590 mm same as above, but plus 1 lift-up door Maximum size of stand-alone Height 400 mm Width 510 mm Depth: 540 430 mm opening height for lift-up door</p> <p>GMB2A 03 LXFB</p>	GMB2A	03	LX	274	304	318	333	353	387	423	10	16	32	4

4.118 Illustrations do not correspond to the door finishes.

Appliance housings with niche height 590 mm

2195 mm high

Unit without plinth, carcass depth 560 mm

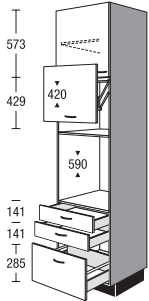
			Price group												
			width	1	2	3	4	5	6	7	Servosoft	Pro Servosoft	ProServoglass	Soft closing Top Motion	Soft closing Top Motion Plus
 <p>Tall unit for appliances with lift-up door Recess height 420 mm niche height 590 mm same as above, but plus 1 lift-up door</p> <p>Maximum size of stand-alone Height 340 mm Width 510 mm Depth: 540 mm</p> <p>430 mm opening height for lift-up door</p> <p><i>For foil-wrapped fronts a set of heat deflector plates are supplied free of charge.</i></p>	GMB2SA	03	LX	282	299	314	329	355	388	424	15	24	32	4	4

Illustrations do not correspond to the door finishes.

Appliance housings with niche height 590 mm

2195 mm high

Unit without plinth, carcass depth 560 mm

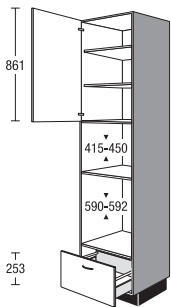
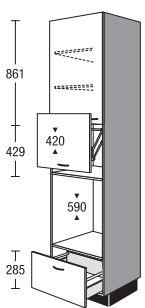
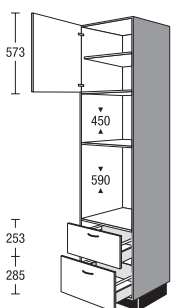
	width	Price group							Servosoft	Pro Servosoft	ProServoGlass	Soft closing Top Motion	Soft closing Top Motion Plus	
		1	2	3	4	5	6	7						
 <p>Tall unit for appliances Recess height 415 - 450 mm Recess height 590 - 592 mm 1 hinged door 2 adjustable shelves 1 deep drawer <i>One front panel per appliance type will be provided for adaptation on site.</i> <i>Recess sizes are adjusted in part through the use of carcass panels.</i> <i>Version supplied may deviate from the illustration according to appliance type.</i> <i>For foil-wrapped fronts a set of heat deflector plates are supplied free of charge.</i></p> <p>GMBA 03 LD</p>	GMBA	03	181	197	206	214	226	244	267	5	8	16	4	4
 <p>Tall unit for appliances with lift-up door Recess height 420 mm niche height 590 mm same as above, but plus 1 lift-up door Maximum size of stand-alone Height 400 mm Width 510 mm Depth: 540 430 mm opening height for lift-up door</p> <p>GMBA 03 LFB</p>	GMBA	03 L	251	273	286	297	313	338	370	5	8	16	4	4
 <p>Tall unit for appliances Niche height 450 mm niche height 590 mm 1 hinged door 1 adjustable shelf 2 deep drawers <i>One front panel per appliance type will be provided for adaptation on site.</i> <i>For cladding up to the ceiling, provision must be made for a ventilation opening of min. 200 cm² in diameter.</i> <i>For foil-wrapped fronts a set of heat deflector plates are supplied free of charge.</i></p> <p>GMB2A 03 YLD</p>	GMB2A	03 Y	189	209	219	230	244	267	292	10	16	32	4	4

4.120 Illustrations do not correspond to the door finishes.

Appliance housings with niche height 590 mm

2195 mm high

Unit without plinth, carcass depth 560 mm

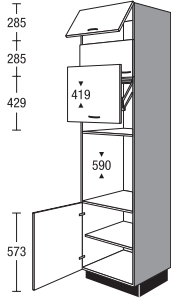
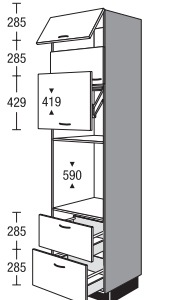
		width	Price group							Servosoft	Pro Servosoft	ProServoglass	Soft closing Top Motion	Soft closing Top Motion Plus	
			1	2	3	4	5	6	7						
 <p>Tall unit for appliances with lift-up door Recess height 419 mm niche height 590 mm 2 flaps 1 lift-up door 1 hinged door 1 adjustable shelf Maximum size of stand-alone Height 390 mm Width 510 mm Depth: 540</p> <p>430 mm opening height for lift-up door</p> <p><i>For foil-wrapped fronts a set of heat deflector plates are supplied free of charge.</i></p>	GMB	03	2KLX	245	275	291	306	328	360	397	-	-	-	15	35
	 <p>Tall unit for appliances with lift-up door Recess height 419 mm niche height 590 mm 2 flaps 1 lift-up door 2 deep drawers Maximum size of stand-alone Height 400 mm Width 510 mm Depth: 540</p> <p>430 mm opening height for lift-up door</p> <p><i>For foil-wrapped fronts a set of heat deflector plates are supplied free of charge.</i></p>	GMB2A	03	2KLX	280	308	323	338	358	391	427	10	16	32	11

Illustrations do not correspond to the door finishes.

Tall shelf units

2195 mm high

Unit without plinth, carcass depth 560 mm

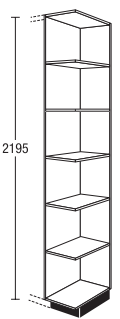
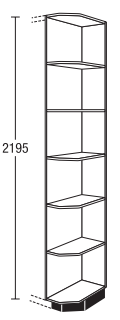
				width	Price group							Servosoft	Pro Servosoft	ProServoGlass	Soft closing Top Motion	Soft closing Top Motion Plus
					1	2	3	4	5	6	7					
	<p>Tall shelf unit</p> <p>5 adjustable shelves</p> <p><i>Finish in carcass material</i></p> <p><i>Please indicate desired width (150-600 mm).</i></p> <p><i>Not available in visible side colours.</i></p>	SR	V	03	218	218	218	218	218	218	218	-	-	-	-	-
	<p><i>Not available in visible side colours.</i></p>															
 <p>Version R</p>	<p>Tall end shelf unit</p> <p>5 fixed shelves</p> <p><i>Measurements with worktop 290 mm</i></p> <p><i>Measurements with modular panel 275 mm</i></p> <p><i>Finish in carcass material</i></p> <p><i>Available in all carcass finishes.</i></p> <p><i>Additional colour variants:</i></p> <p>112 Cappuccino</p> <p>121 Thyme</p> <p>133 Volcano brown</p> <p>134 Alby Blue</p> <p>158 Sage green</p> <p>952 Petrol</p> <p><i>Not available in visible side colours.</i></p>	SRA	30	03	171	171	171	171	171	171	171	-	-	-	-	-
	<p><i>Not available in visible side colours.</i></p>															
 <p>Version R</p>	<p>Tall end shelf unit angled</p> <p>5 fixed shelves</p> <p><i>Finish in carcass material</i></p> <p><i>Not available in visible side colours.</i></p>	SRA	25	03 S	158	158	158	158	158	158	158	-	-	-	-	-
	<p><i>Not available in visible side colours.</i></p>															

4.122 Illustrations do not correspond to the door finishes.

Filler panels, Miscellaneous

2195 mm high

with neutral door division

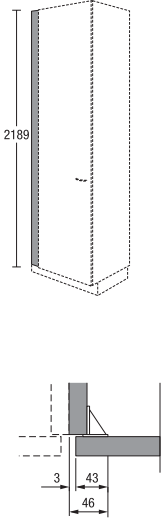
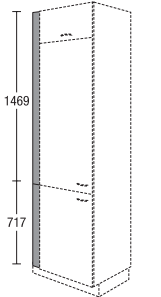
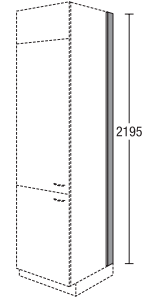
						Price group											
		width				1	2	3	4	5	6	7	Servosoft	Pro Servosoft	ProServoglass	Soft closing Top Motion	Soft closing Top Motion Plus
 <p>Infill panel for tall unit without plinth, 2195 mm high Fitted between wall and carcass side</p> <p><i>Finish in continuous door material without edging on the wall side</i></p> <p><i>Not available for the following fronts: IP 2200, Vintage oak effect no. 138 IP 2200, Light oak effect no. 141 IP 2200, Oregon oak effect no. 142 IP 2200, Oak effect black no. 143 IP 2200, Summerfield oak effect no. 163</i></p> <p><i>Not available in visible side colours.</i></p> <p><i>Due to the installation angle, the maximum possible on-site width reduction is 46 mm.</i></p>	SPF	10	03	E	29	32	34	36	38	41	45	-	-	-	-	-	
	SPF	20	03	E	40	43	44	46	50	54	60	-	-	-	-	-	
<p>Infill panel for tall unit without plinth, 2195 mm high</p> <p><i>Finish in carcass material</i></p> <p><i>Not available in visible side colours.</i></p>	SPK	10	03		20	20	20	20	20	20	20	-	-	-	-	-	
	SPK	20	03		27	27	27	27	27	27	27	-	-	-	-	-	
	SPK	30	03		33	33	33	33	33	33	33	-	-	-	-	-	
 <p>Infill panel for tall unit without plinth, 2195 mm high Neutral door division. Fitted between wall and carcass side</p> <p><i>Finish in door material without edging on the wall side</i></p> <p><i>Available for the following fronts: IP 2200, Vintage oak effect no. 138 IP 2200, Light oak effect no. 141 IP 2200, Oregon oak effect no. 142 IP 2200, Oak effect black no. 143 IP 2200, Summerfield oak effect no. 163</i></p> <p><i>Not available in visible side colours.</i></p> <p><i>Due to the installation angle, the maximum possible on-site width reduction is 46 mm.</i></p>	SPF	10	03		27	30	31	33	35	38	42	-	-	-	-	-	
	SPF	20	03		40	43	44	46	50	54	60	-	-	-	-	-	
 <p>Infill panel for tall-unit side for wall join etc.</p> <p>without plinth, 2195 mm high</p> <p><i>Finish in carcass material</i></p> <p><i>for deeper units, order plinth SO 151 separately</i></p> <p><i>Not available in visible side colours.</i></p>	SPT	10	03		20	20	20	20	20	20	20	-	-	-	-	-	
	SPT	20	03		23	23	23	23	23	23	23	-	-	-	-	-	
	SPT	30	03		26	26	26	26	26	26	26	-	-	-	-	-	

Illustrations do not correspond to the door finishes.

Filler panels, Miscellaneous

2195 mm high

with neutral door division

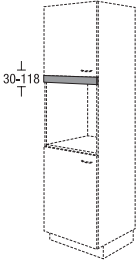
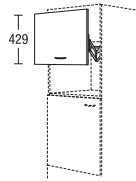
		width		Price group							Servosoft	Pro Servosoft	ProServoGlass	Soft closing Top Motion	Soft closing Top Motion Plus
				1	2	3	4	5	6	7					
 <p>Door material infill panel for appliance housing units For covering the carcass inner panel with edge protection stainless steel coloured Height 30-118 mm <i>Please state the desired height.</i></p>	FBG	60	G	25	29	30	31	33	35	40	-	-	-	-	-
	<p>Door material infill panel for appliance housing units For covering the carcass inner panel with edge protection stainless steel coloured Height 118 mm for on-site adaptation</p>	FBG	60	Z	20	23	24	25	26	28	32	-	-	-	-
 <p>Lift-up door for microwave niche for retrofitting on site For tall units / highboards with niche height 410 mm Max. size of standing appliance Height: 370 mm Width: 510 mm Depth: 540 mm <i>370 mm opening height for lift-up door</i></p>	LKP	60	43	60	63	64	66	73	79	88	-	-	-	-	-

Modules for raised dishwashers

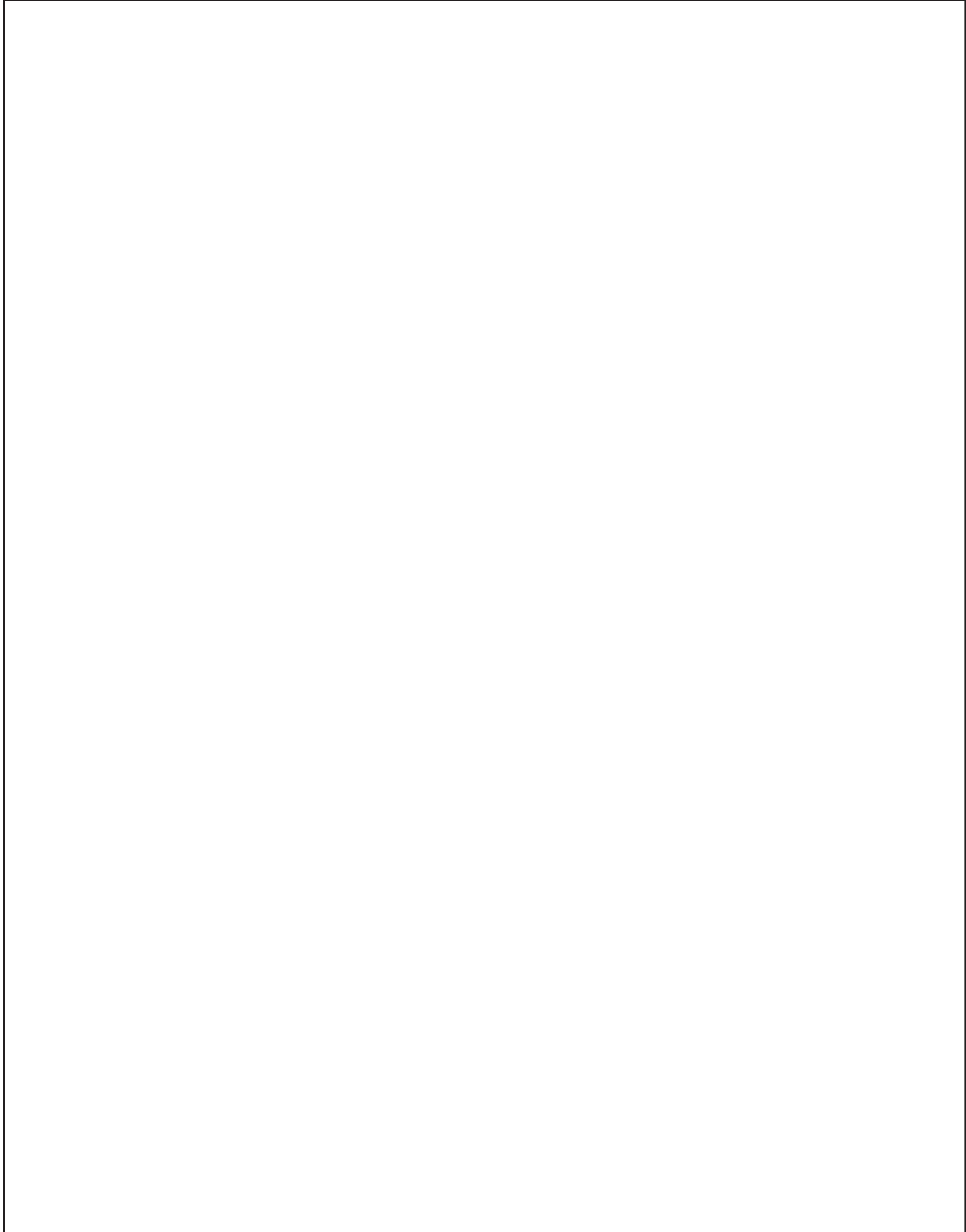

Modules for raised
dishwashers

Modules for raised
dishwashers

Module sets for raised dishwashers

1043 mm high

Unit without worktop and plinth, carcass depth 560 mm. Order worktop separately.

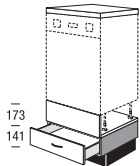
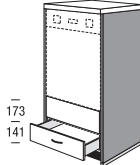
		width	Price group							Servosoft	Pro Servosoft	ProServoGlass	Soft closing Top Motion	Soft closing Top Motion Plus			
			1	2	3	4	5	6	7								
 <p>Modular unit for raised dishwasher</p> <p>Set comprising: 1 plinth platform with 1 front panel 1 drip tray, silver grey 1 base unit 147 mm high with 1 drawer</p> <p><i>Order dishwasher front panel and highboard cover separately.</i></p> <p><i>Max. appliance height 871 mm Not suitable for XXL appliances Please check whether dishwasher is approved for raised installation.</i></p> <p><i>The delivery comprises several packages.</i></p> <p><i>Not available for the following ranges: IP 4820, IP 7500</i></p>	GGS	104	B	115	124	135	146	177	190	208	5	8	8	-	-		
	 <p>Modular unit for raised dishwasher including panels</p> <p>Set comprising: 2 side modular panels (16 mm with panel support, 585 mm deep) 1 plinth platform with 1 front panel 1 drip tray, silver grey 1 base unit 147 mm high with 1 drawer</p> <p><i>Order dishwasher front panel and highboard cover separately.</i></p> <p><i>Max. appliance height 871 mm Not suitable for XXL appliances Please check whether dishwasher is approved for raised installation.</i></p> <p><i>The delivery comprises several packages.</i></p> <p><i>Not available for the following ranges: IP 4820, IP 7500</i></p>	GGS	63	104	B	197	213	231	250	303	325	356	5	8	8	-	-
		<p>Modular unit for raised dishwasher including panels</p> <p>same as above, but 2 lateral modular panels (25 mm with panel shoe)</p>	GGS	65	104	B	204	220	240	259	314	337	369	5	8	8	-

Illustrations do not correspond to the door finishes.

Module sets for raised dishwashers

1475 mm high

Unit without worktop and plinth, carcass depth 560 mm. Order worktop separately.

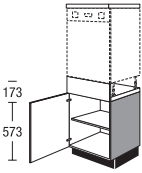
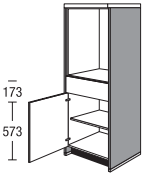
	width	Price group							Servosoft	Pro Servosoft	ProServoGlass	Soft closing Top Motion	Soft closing Top Motion Plus			
		1	2	3	4	5	6	7								
 <p>Modular unit for raised dishwasher</p> <p>Set comprising: 1 plinth platform with 1 front panel 1 base unit 579 mm high with 1 hinged door 1 adjustable shelf 1 drip tray, silver grey</p> <p><i>Order dishwasher front panel and highboard cover separately.</i></p> <p><i>Max. appliance height 871 mm</i></p> <p><i>Not suitable for XXL appliances Please check whether dishwasher is approved for raised installation.</i></p> <p><i>The delivery comprises several packages.</i></p> <p><i>Not available for the following ranges: IP 4820, IP 7500</i></p>	GG	148	BX	116	138	154	172	212	249	295	-	-	-	4	4	
 <p>Modular unit for raised dishwasher including panels</p> <p>to be placed under an integrated dishwasher, suitable for highboards</p> <p>Set comprising: 2 side modular panels (16 mm with panel support, 585 mm deep) 1 plinth platform with 1 front panel 1 base unit 579 mm high with 1 hinged door 1 adjustable shelf 1 drip tray, silver grey</p> <p><i>Panel finish: Panel colours</i></p> <p><i>Order dishwasher front panel and highboard cover separately.</i></p> <p><i>Max. appliance height 871 mm</i></p> <p><i>Not suitable for XXL appliances Please check whether dishwasher is approved for raised installation.</i></p> <p><i>The delivery comprises several packages.</i></p> <p><i>Not available for the following ranges: IP 4820, IP 7500</i></p>	GG	63	148	BX	232	254	270	288	328	365	411	-	-	-	4	4
<p>Modular unit for raised dishwasher including panels</p> <p>same as above, but 2 lateral modular panels (25 mm with panel shoe)</p>	GG	65	148	BX	242	260	276	294	334	371	417	-	-	-	4	4

4.126 Illustrations do not correspond to the door finishes.

Module sets for raised dishwashers

1475 mm high

Unit without worktop and plinth, carcass depth 560 mm. Order worktop separately.

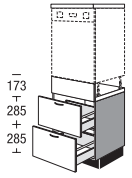
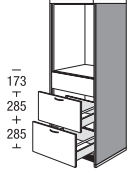
						Price group												
		width				1	2	3	4	5	6	7	Servosoft	Pro Servosoft	ProServoGlass	Soft closing Top Motion	Soft closing Top Motion Plus	
	Modular unit for raised dishwasher Set comprising: 1 plinth platform with 1 front panel 1 base unit 579 mm high with 2 deep drawers 1 drip tray, silver grey <i>Order dishwasher front panel and highboard cover separately.</i> <i>Max. appliance height 871 mm</i> <i>Not suitable for XXL appliances</i> <i>Please check whether dishwasher is approved for raised installation.</i> <i>The delivery comprises several packages.</i> <i>Not available for the following ranges:</i> IP 4820, IP 7500	GG2A	148	BX	159	190	206	224	274	320	382	10	16	32	-	-		
		Modular unit for raised dishwasher including panels to be placed under an integrated dishwasher, suitable for highboards Set comprising: 2 side modular panels (16 mm with panel support, 585 mm deep) 1 plinth platform with 1 front panel 1 base unit 579 mm high with 2 deep drawers 1 drip tray, silver grey <i>Panel finish:</i> Panel colours <i>Order dishwasher front panel and highboard cover separately.</i> <i>Max. appliance height 871 mm</i> <i>Not suitable for XXL appliances</i> Please check whether dishwasher is approved for raised installation. <i>The delivery comprises several packages.</i> <i>Not available for the following ranges:</i> IP 4820, IP 7500	GG2A	63	148	BX	275	306	322	340	390	436	498	10	16	32	-	-
	Modular unit for raised dishwasher including panels same as above, but 2 lateral modular panels (25 mm with panel shoe)	GG2A	65	148	BX	285	312	328	346	396	442	505	10	16	32	-	-	

Illustrations do not correspond to the door finishes.

Module sets for raised dishwashers

1475 mm high

Unit without worktop and plinth, carcass depth 560 mm. Order worktop separately.

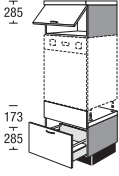
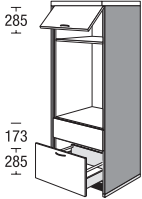
	GGA	width		Price group							Servosoft	Pro Servosoft	ProServoGlass	Soft closing Top Motion	Soft closing Top Motion Plus
				1	2	3	4	5	6	7					
 <p>Modular unit for raised dishwasher</p> <p>Set comprising: 1 dresser unit with 1 flap door 1 plinth platform with 1 front panel 1 base unit 291 mm high with 1 deep drawer 1 drip tray, silver grey</p> <p><i>Order dishwasher front panel and highboard cover separately.</i></p> <p><i>Max. appliance height 868 mm Not suitable for XXL appliances</i></p> <p><i>Please check whether dishwasher is approved for raised installation.</i></p> <p><i>The delivery comprises several packages.</i></p> <p><i>Not available for the following ranges: IP 4820, IP 7500</i></p>			148 KB	149	149	162	176	208	243	287	5	8	16	7	17
 <p>Modular unit for raised dishwasher including panels</p> <p>to be placed under an integrated dishwasher, suitable for highboards</p> <p>Set comprising: 2 side modular panels (16 mm with panel support, 585 mm deep) 1 dresser unit with 1 flap door 1 plinth platform with 1 front panel 1 base unit 291 mm high with 1 deep drawer 1 drip tray, silver grey</p> <p><i>Panel finish: Panel colours</i></p> <p><i>Order dishwasher front panel and highboard cover separately.</i></p> <p><i>Max. appliance height 868 mm Not suitable for XXL appliances</i></p> <p><i>Please check whether dishwasher is approved for raised installation.</i></p> <p><i>The delivery comprises several packages.</i></p> <p><i>Not available for the following ranges: IP 4820, IP 7500</i></p>		63	148 KB	232	244	257	271	303	338	382	5	8	16	7	17
<p>Modular unit for raised dishwasher including panels</p> <p>same as above, but 2 lateral modular panels (25 mm with panel shoe)</p>		65	148 KB	242	250	263	277	309	344	388	5	8	16	7	17

4.128 Illustrations do not correspond to the door finishes.

Module sets for raised dishwashers

1475 mm high

Unit without worktop and plinth, carcass depth 560 mm. Order worktop separately.

		width	Price group							Servosoft	Pro Servosoft	ProServoglass	Soft closing Top Motion	Soft closing Top Motion Plus		
			1	2	3	4	5	6	7							
	<p>Modular unit for raised dishwasher</p> <p>Set comprising: 1 dresser unit with 1 flap door 1 plinth base 1 base unit 291 mm high with 1 deep drawer (deep drawer front piece 461 mm high) 1 drip tray, silver grey</p> <p><i>Order dishwasher front panel and highboard cover separately.</i></p> <p><i>Max. appliance height 868 mm Not suitable for XXL appliances</i></p> <p><i>Please check whether dishwasher is approved for raised installation.</i></p> <p><i>The delivery comprises several packages.</i></p> <p><i>Strip handles 740, 760, 780, 790 and 800 not possible.</i></p> <p><i>Not available for the following ranges: IP 4820, IP 7500</i></p>	GGA	148	K	149	158	171	185	217	252	296	5	8	16	7	17

Illustrations do not correspond to the door finishes.

Module sets for raised dishwashers

1475 mm high

Unit without worktop and plinth, carcass depth 560 mm. Order worktop separately.

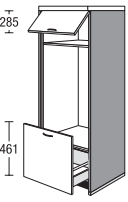
	width	Price group							Servosoft	Pro Servosoft	ProServoGlass	Soft closing Top Motion	Soft closing Top Motion Plus			
		1	2	3	4	5	6	7								
 <p>Modular unit for raised dishwasher Including panels</p> <p>to be placed under an integrated dishwasher, suitable for highboards</p> <p>Set comprising: 2 side modular panels (16 mm with panel support, 585 mm deep) 1 dresser unit with 1 flap door 1 plinth base 1 base unit 291 mm high with 1 deep drawer (deep drawer front piece 461 mm high) 1 drip tray, silver grey</p> <p><i>Panel finish:</i> <i>Panel colours</i></p> <p><i>Order dishwasher front panel and highboard cover separately.</i></p> <p><i>Max. appliance height 868 mm</i> <i>Not suitable for XXL appliances</i></p> <p><i>Please check whether dishwasher is approved for raised installation.</i></p> <p><i>The delivery comprises several packages.</i></p> <p><i>Strip handles 740, 760, 780, 790 and 800 not possible.</i></p> <p><i>Not available for the following ranges:</i> <i>IP 4820, IP 7500</i></p>	GGA	63	148	K	232	237	250	264	296	331	375	5	8	16	7	17
	<p>Modular unit for raised dishwasher Including panels</p> <p>same as above, but 2 lateral modular panels (25 mm with panel shoe)</p>	GGA	65	148	K	242	243	256	270	302	337	381	5	8	16	7

Module sets for raised dishwashers

Height 01, tall unit height 1907 mm

Unit without plinth, carcass depth 560 mm

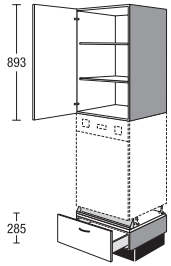

		width	Price group							Servosoft	Pro Servosoft	ProServoglass	Soft closing Top Motion	Soft closing Top Motion Plus
			1	2	3	4	5	6	7					
 <p>Modular unit for raised dishwasher</p> <p>Set comprising: 1 top unit with 1 hinged door 2 adjustable shelves 1 plinth platform with 1 drip tray, silver grey 1 base unit 147 mm high with 1 drawer 285 mm high</p> <p><i>Order dishwasher front panel and highboard cover separately.</i></p> <p><i>Max. appliance height 836 mm Not suitable for XXL appliances</i></p> <p><i>Please check whether dishwasher is approved for raised installation.</i></p> <p><i>The delivery comprises several packages.</i></p> <p><i>Strip handles 740, 760, 780, 790 and 800 not possible.</i></p> <p><i>Not available for the following ranges: IP 4820, IP 7500</i></p>	GGS	01	202	218	235	251	294	321	355	5	8	8	4	4
														

Illustrations do not correspond to the door finishes.

Module sets for raised dishwashers

Height 02, tall unit height 2051 mm

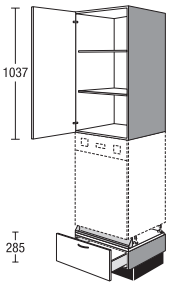
Unit without plinth, carcass depth 560 mm



	width	Price group							Servosoft	Pro Servosoft	ProServoGlass	Soft closing Top Motion	Soft closing Top Motion Plus	
		1	2	3	4	5	6	7						
 <p>Modular unit for raised dishwasher</p> <p>Set comprising: 1 top unit with 1 hinged door 2 adjustable shelves 1 plinth platform with 1 drip tray, silver grey 1 base unit 147 mm high with 1 drawer 285 mm high</p> <p><i>Order dishwasher front panel and highboard cover separately.</i></p> <p><i>Max. appliance height 836 mm Not suitable for XXL appliances</i></p> <p><i>Please check whether dishwasher is approved for raised installation.</i></p> <p><i>The delivery comprises several packages.</i></p> <p><i>Strip handles 740, 760, 780, 790 and 800 not possible.</i></p> <p><i>Not available for the following ranges: IP 4820, IP 7500</i></p> 	GGS	02	225	243	261	279	327	357	405	5	8	8	4	4

4.132 Illustrations do not correspond to the door finishes.

Module sets for raised dishwashers

Height 03, tall unit height 2195 mm

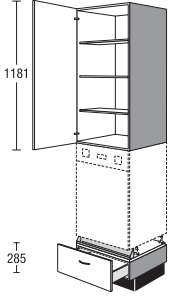
Unit without plinth, carcass depth 560 mm

		width	Price group							Servosoft	Pro Servosoft	ProServoglass	Soft closing Top Motion	Soft closing Top Motion Plus	
			1	2	3	4	5	6	7						
	<p>Modular unit for raised dishwasher</p> <p>Set comprising:</p> <ul style="list-style-type: none"> 1 top unit with 1 hinged door 3 adjustable shelves 1 plinth platform with 1 drip tray, silver grey 1 base unit 147 mm high with 1 drawer 285 mm high <p><i>Order dishwasher front panel and highboard cover separately.</i></p> <p><i>Max. appliance height 836 mm</i> <i>Not suitable for XXL appliances</i></p> <p><i>Please check whether dishwasher is approved for raised installation.</i></p> <p><i>The delivery comprises several packages.</i></p> <p><i>Strip handles 740, 760, 780, 790 and 800 not possible.</i></p> <p><i>Not available for the following ranges:</i> <i>IP 4820, IP 7500</i></p>	GGS	03	237	255	271	288	324	360	422	5	8	8	6	6
															

Illustrations do not correspond to the door finishes.

Module combinations for raised dishwashers

1043 mm high

Unit without worktop and plinth, carcass depth 560 mm. Order worktop separately.

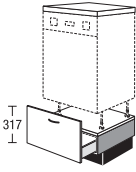
	width	Price group							Servosoft	Pro Servosoft	ProServoGlass	Soft closing Top Motion	Soft closing Top Motion Plus			
		1	2	3	4	5	6	7								
 <p>Modular unit for raised dishwasher</p> <p>Set comprising: 1 plinth platform with 1 drip tray, silver grey 1 base unit 147 mm high with 1 drawer 317 mm high</p> <p><i>Order dishwasher front panel and highboard cover separately.</i></p> <p><i>Max. appliance height 868 mm Not suitable for XXL appliances Please check whether dishwasher is approved for raised installation.</i></p> <p><i>The delivery comprises several packages.</i></p> <p><i>Available for the following ranges: IP 1200, IP 2200, IP 3150, IP 4050</i></p> <p><i>Strip handles 740, 760, 780, 790 and 800 not possible.</i></p>	US	60	32	GS	108	117	127	137	166	178	195	5	8	8	-	-
<p>Modular unit for raised dishwasher</p> <p>same as above, but 1 base unit 147 mm high with 1 drawer 317 mm high, 400 mm deep</p>	US	60	32	K1GS	128	131	132	134	140	142	147	-	4	12	-	-

4.134 Illustrations do not correspond to the door finishes.

Module combinations for raised dishwashers

1475 mm high

Unit without worktop and plinth, carcass depth 560 mm. Order worktop separately.

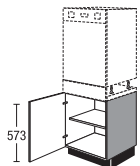
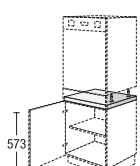
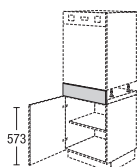
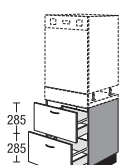
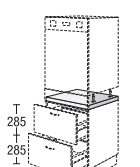
		width		Price group							Servosoft	Pro Servosoft	ProServoglass	Soft closing Top Motion	Soft closing Top Motion Plus	
		60	58	1	2	3	4	5	6	7						
 <p>Modular unit for raised dishwasher For installing integrated dishwashers</p> <p>1 hinged door 1 adjustable shelf</p> <p><i>Plinth platform SOP 60 and fixed panel FB 60 17 GS must be ordered separately.</i></p> <p><i>Order front panel and highboard cover separately.</i></p> <p><i>When using as a stand-alone or at the end of a run, a support panel or carcass material is required as cladding.</i></p>	U	60	58	63	69	74	79	91	93	98	-	-	-	4	4	
	 <p>Plinth platform without plinth feet for dishwasher</p> <p><i>Please order front panel for dishwasher separately.</i></p> <p><i>Please check whether dishwasher is approved for raised installation.</i></p>	SOP	60		31	31	31	31	31	31	31	-	-	-	-	-
		 <p>Fixed front panel on plinth platform For installing dishwashers Door height: 173 mm</p> <p><i>Not available for the following ranges: IP 4820, IP 7500</i></p>	FB	60	17 GS	30	31	34	36	38	40	44	-	-	-	-
 <p>Modular unit for raised dishwasher For installing dishwashers</p> <p>2 deep drawers</p> <p><i>Plinth platform SOP 60 and fixed panel FB 60 17 GS must be ordered separately.</i></p> <p><i>Order front panel and highboard cover separately.</i></p> <p><i>When using as a stand-alone or at the end of a run, a support panel or carcass material is required as cladding.</i></p>	U2A	60	58	106	118	124	131	152	164	180	10	16	32	-	-	
	 <p>Plinth platform without plinth feet for dishwasher</p> <p><i>Please order front panel for dishwasher separately.</i></p> <p><i>Please check whether dishwasher is approved for raised installation.</i></p>	SOP	60		31	31	31	31	31	31	31	-	-	-	-	-

Illustrations do not correspond to the door finishes.

4.135

Module combinations for raised dishwashers

1475 mm high

Unit without worktop and plinth, carcass depth 560 mm. Order worktop separately.

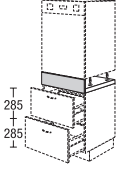

		width	Price group							Servosoft	Pro Servosoft	ProServoGlass	Soft closing Top Motion	Soft closing Top Motion Plus	
			1	2	3	4	5	6	7						
 <p>Fixed front panel on plinth platform For installing dishwashers Door height: 173 mm <i>Not available for the following ranges: IP 4820, IP 7500</i></p>	FB	60	17	GS	30	31	34	36	38	40	44	-	-	-	-

4.136 Illustrations do not correspond to the door finishes.

Module combinations for raised dishwashers

1475 mm high

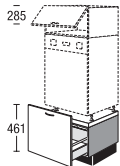
Unit without worktop and plinth, carcass depth 560 mm. Order worktop separately.

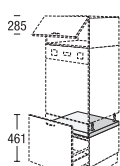
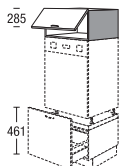

						Price group											
		width				1	2	3	4	5	6	7	Servosoft	Pro Servosoft	ProServoGlass	Soft closing Top Motion	Soft closing Top Motion Plus
 <p>Modular unit for raised dishwasher For installing integrated dishwashers</p> <p>1 base unit 291 mm high with 1 deep drawer (deep drawer front piece 461 mm high) 1 drip tray, silver grey</p> <p><i>Order front panel and highboard cover separately. When using as a stand-alone or at the end of a run, a support panel or carcass material is required as cladding.</i></p> <p><i>Strip handles 740, 760, 780, 790 and 800 not possible.</i></p> <p><i>Not available for the following ranges: IP 4820, IP 7500</i></p>	UA	60	46	GS	123	128	134	141	159	166	178	5	8	16	-	-	
																	
<p>Modular unit for raised dishwasher same as above, but 1 base unit 291 mm high with 1 pull-out (front piece 461 mm high), 400 mm deep</p>	UA	60	46	K1GS	133	138	145	152	172	179	192	-	3	11	-	-	
 <p>Plinth platform without plinth feet for dishwasher</p> <p><i>Please order front panel for dishwasher separately.</i></p> <p><i>Please check whether dishwasher is approved for raised installation.</i></p>	SOP	60			31	-	-	-	-	-							
 <p>Dresser unit 291 mm high</p> <p>1 flap door</p> <p><i>Handle only fitted horizontally</i></p> <p><i>Bottom shelf white.</i></p>	AK AK	60 90	29 29		51 66	54 70	57 74	60 77	66 86	70 90	76 99	- -	- -	- -	7 7	17 17	

Illustrations do not correspond to the door finishes.

Module combinations for raised dishwashers

Height 01, tall unit height 1907 mm

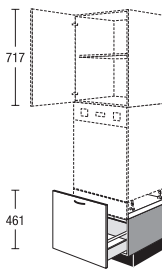
Unit without worktop and plinth, carcass depth 560 mm. Order worktop separately.

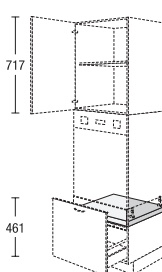
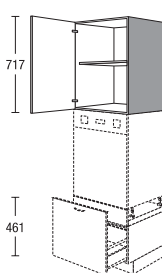
	width	Price group							Servosoft	Pro Servosoft	ProServoGlass	Soft closing Top Motion	Soft closing Top Motion Plus			
		1	2	3	4	5	6	7								
 <p>Modular unit for raised dishwasher For installing dishwashers</p> <p>1 base unit 291 mm high with 1 deep drawer (deep drawer front piece 461 mm high) 1 drip tray, silver grey</p> <p><i>Order front panel and highboard cover separately.</i></p> <p><i>When using as a stand-alone or at the end of a run, a support panel or carcass material is required as cladding.</i></p> <p><i>Strip handles 740, 760, 780, 790 and 800 not possible.</i></p> <p><i>Not available for the following ranges: IP 4820, IP 7500</i></p> 	UA	60	46	GS	123	128	134	141	159	166	178	5	8	16	-	-
<p>Modular unit for raised dishwasher</p> <p>same as above, but 1 base unit 291 mm high with 1 pull-out (front piece 461 mm high), 400 mm deep</p>	UA	60	46	K1GS	133	138	145	152	172	179	192	-	3	11	-	-
 <p>Plinth platform without plinth feet for dishwasher</p> <p><i>Please order front panel for dishwasher separately.</i></p> <p><i>Please check whether dishwasher is approved for raised installation.</i></p>	SOP	60			31	-	-	-	-	-	-					
 <p>Dresser unit as top unit on electrical appliances</p> <p>1 hinged door 1 adjustable shelf</p> <p><i>Can only be installed between modular panels or units.</i></p> <p><i>Bottom shelf white.</i></p>	A	60	72		70	76	80	85	95	105	118	-	-	-	4	4

4.138 Illustrations do not correspond to the door finishes.

Module combinations for raised dishwashers

Height 01, tall unit height 1907 mm

Unit without worktop and plinth, carcass depth 560 mm. Order worktop separately.

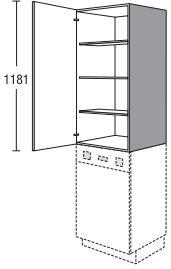
		width	Price group							Servosoft	Pro Servosoft	ProServoGlass	Soft closing Top Motion	Soft closing Top Motion Plus		
			1	2	3	4	5	6	7							
	<p>Dresser unit</p> <p>1187 mm high (height 01)</p> <p>as top unit on electrical appliances</p> <p>1 hinged door 3 adjustable shelves</p> <p><i>Bottom shelf white.</i></p> <p><i>Can only be installed between modular panels or units.</i></p>	A	60	118	131	141	150	159	179	199	233	-	-	-	6	6
	<p>Illustration shows height 01</p>															

Illustrations do not correspond to the door finishes.

Module combinations for raised dishwashers

Height 02, tall unit height 2051 mm

Unit without worktop and plinth, carcass depth 560 mm. Order worktop separately.

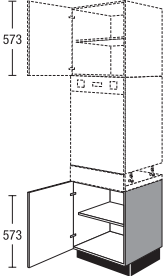
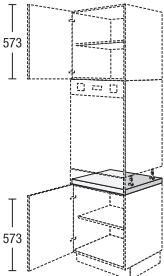
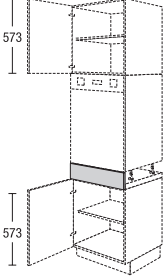
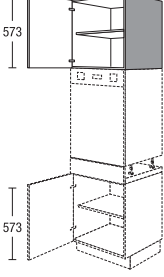

		width	Price group							Servosoft	Pro Servosoft	ProServoGlass	Soft closing Top Motion	Soft closing Top Motion Plus	
			1	2	3	4	5	6	7						
 <p>Modular unit for raised dishwasher For installing integrated dishwashers</p> <p>1 hinged door 1 adjustable shelf</p> <p><i>Plinth platform SOP 60 and fixed panel FB 60 17 GS must be ordered separately.</i></p> <p><i>Order front panel and highboard cover separately.</i></p> <p><i>When using as a stand-alone or at the end of a run, a support panel or carcass material is required as cladding.</i></p>	U	60	58	63	69	74	79	91	93	98	-	-	-	4	4
 <p>Plinth platform without plinth feet for dishwasher</p> <p><i>Please order front panel for dishwasher separately.</i></p> <p><i>Please check whether dishwasher is approved for raised installation.</i></p>	SOP	60		31	31	31	31	31	31	31	-	-	-	-	-
 <p>Fixed front panel on plinth platform For installing dishwashers Door height: 173 mm</p> <p><i>Not available for the following ranges: IP 4820, IP 7500</i></p>	FB	60	17 GS	30	31	34	36	38	40	44	-	-	-	-	-
 <p>Dresser unit as top unit on electrical appliances</p> <p>1 hinged door 1 adjustable shelf</p> <p><i>Can only be installed between modular panels or units.</i></p> <p><i>Bottom shelf white.</i></p>	<input checked="" type="checkbox"/> A	60	58	65	70	74	78	88	97	110	-	-	-	4	4

4.140 Illustrations do not correspond to the door finishes.

Module combinations for raised dishwashers

Height 02, tall unit height 2051 mm

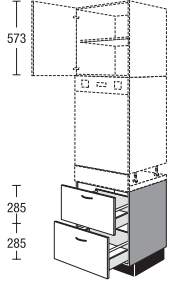
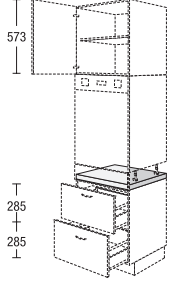
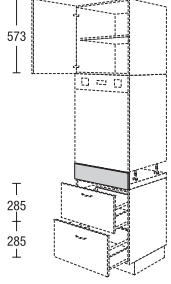
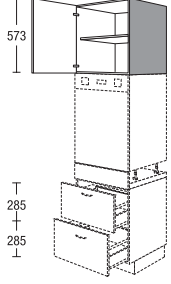
Unit without worktop and plinth, carcass depth 560 mm. Order worktop separately.



				Price group												
				width	1	2	3	4	5	6	7	Servosoft	Pro Servosoft	ProServoglass	Soft closing Top Motion	Soft closing Top Motion Plus
	Modular unit for raised dishwasher For installing dishwashers 2 deep drawers <i>Plinth platform SOP 60 and fixed panel FB 60 17 GS must be ordered separately.</i> <i>Order front panel and highboard cover separately.</i> <i>When using as a stand-alone or at the end of a run, a support panel or carcass material is required as cladding.</i>	U2A	60 58		106	118	124	131	152	164	180	10	16	32	-	-
	Plinth platform without plinth feet for dishwasher <i>Please order front panel for dishwasher separately.</i> <i>Please check whether dishwasher is approved for raised installation.</i>	SOP	60	31	31	31	31	31	31	31	-	-	-	-	-	
	Fixed front panel on plinth platform For installing dishwashers Door height: 173 mm <i>Not available for the following ranges: IP 4820, IP 7500</i>	FB	60 17 GS	30	31	34	36	38	40	44	-	-	-	-	-	
	Dresser unit as top unit on electrical appliances 1 hinged door 1 adjustable shelf <i>Can only be installed between modular panels or units.</i> <i>Bottom shelf white.</i>	 A	60 58	65	70	74	78	88	97	110	-	-	-	4	4	

Illustrations do not correspond to the door finishes.

Module combinations for raised dishwashers

Height 02, tall unit height 2051 mm

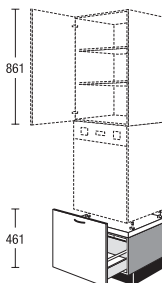
Unit without worktop and plinth, carcass depth 560 mm. Order worktop separately.

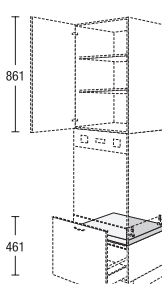
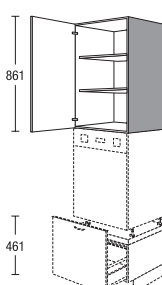
		width	Price group							Servosoft	Pro Servosoft	ProServoGlass	Soft closing Top Motion	Soft closing Top Motion Plus		
			1	2	3	4	5	6	7							
 <p>Modular unit for raised dishwasher For installing dishwashers</p> <p>1 base unit 291 mm high with 1 deep drawer (deep drawer front piece 461 mm high) 1 drip tray, silver grey</p> <p><i>Order front panel and highboard cover separately.</i></p> <p><i>When using as a stand-alone or at the end of a run, a support panel or carcass material is required as cladding.</i></p> <p><i>Strip handles 740, 760, 780, 790 and 800 not possible.</i></p> <p><i>Not available for the following ranges: IP 4820, IP 7500</i></p>	UA	60	46	GS	123	128	134	141	159	166	178	5	8	16	-	-
																
<p>Modular unit for raised dishwasher</p> <p>same as above, but 1 base unit 291 mm high with 1 pull-out (front piece 461 mm high), 400 mm deep</p>	UA	60	46	K1GS	133	138	145	152	172	179	192	-	3	11	-	-
 <p>Plinth platform without plinth feet for dishwasher</p> <p><i>Please order front panel for dishwasher separately.</i></p> <p><i>Please check whether dishwasher is approved for raised installation.</i></p>	SOP	60			31	-	-	-	-	-						
 <p>Dresser unit as top unit on electrical appliances</p> <p>1 hinged door 2 adjustable shelves</p> <p><i>Can only be installed between modular panels or units.</i></p> <p><i>Bottom shelf white.</i></p>	A	60	87		85	91	97	103	115	128	143	-	-	-	4	4

4.142 Illustrations do not correspond to the door finishes.

Module combinations for raised dishwashers

Height 03, tall unit height 2195 mm

Unit without worktop and plinth, carcass depth 560 mm. Order worktop separately.

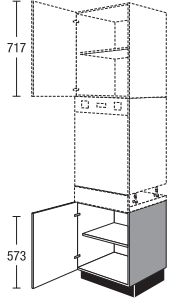
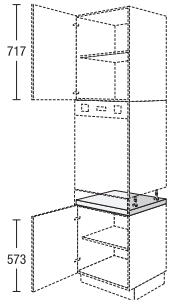
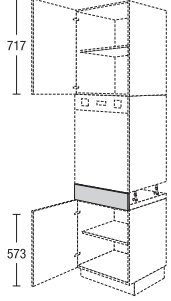
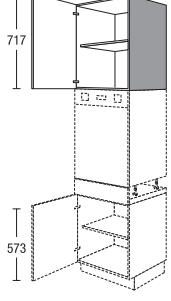
		width		Price group							ServoSoft	Pro ServoSoft	ProServoGlass	Soft closing Top Motion	Soft closing Top Motion Plus
		60	58	1	2	3	4	5	6	7	-	-	-	4	4
 <p>Modular unit for raised dishwasher For installing integrated dishwashers</p> <p>1 hinged door 1 adjustable shelf</p> <p><i>Plinth platform SOP 60 and fixed panel FB 60 17 GS must be ordered separately.</i></p> <p><i>Order front panel and highboard cover separately.</i></p> <p><i>When using as a stand-alone or at the end of a run, a support panel or carcass material is required as cladding.</i></p>	U	60	58	63	69	74	79	91	93	98	-	-	-	4	4
 <p>Plinth platform without plinth feet for dishwasher</p> <p><i>Please order front panel for dishwasher separately.</i></p> <p><i>Please check whether dishwasher is approved for raised installation.</i></p>	SOP	60		31	31	31	31	31	31	31	-	-	-	-	-
 <p>Fixed front panel on plinth platform For installing dishwashers Door height: 173 mm</p> <p><i>Not available for the following ranges: IP 4820, IP 7500</i></p>	FB	60	17 GS	30	31	34	36	38	40	44	-	-	-	-	-
 <p>Dresser unit as top unit on electrical appliances</p> <p>1 hinged door 2 adjustable shelves</p> <p><i>Can only be installed between modular panels or units.</i></p> <p><i>Bottom shelf white.</i></p>	A	60	72	70	76	80	85	95	105	118	-	-	-	4	4

Illustrations do not correspond to the door finishes.

Module combinations for raised dishwashers

Height 03, tall unit height 2195 mm

Unit without worktop and plinth, carcass depth 560 mm. Order worktop separately.

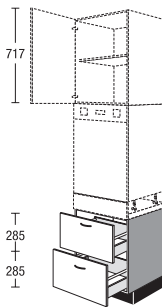
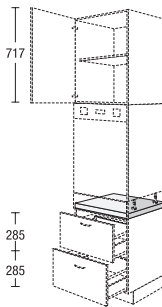
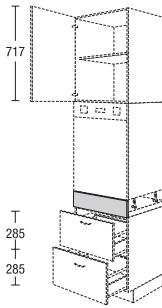
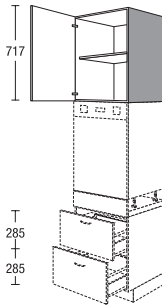
	width	Price group							Servosoft	Pro Servosoft	ProServoGlass	Soft closing Top Motion	Soft closing Top Motion Plus			
		1	2	3	4	5	6	7								
 <p>Modular unit for raised dishwasher For installing dishwashers 2 deep drawers <i>Plinth platform SOP 60 and fixed panel FB 60 17 GS must be ordered separately.</i> <i>Order front panel and highboard cover separately.</i> <i>When using as a stand-alone or at the end of a run, a support panel or carcass material is required as cladding.</i></p>	U2A	60	58	106	118	124	131	152	164	180	10	16	32	-	-	
 <p>Plinth platform without plinth feet for dishwasher <i>Please order front panel for dishwasher separately.</i> <i>Please check whether dishwasher is approved for raised installation.</i></p>	SOP	60		31	31	31	31	31	31	31	-	-	-	-	-	
 <p>Fixed front panel on plinth platform For installing dishwashers Door height: 173 mm <i>Not available for the following ranges: IP 4820, IP 7500</i></p>	FB	60	17	GS	30	31	34	36	38	40	44	-	-	-	-	
 <p>Dresser unit as top unit on electrical appliances 1 hinged door 1 adjustable shelf <i>Can only be installed between modular panels or units.</i> <i>Bottom shelf white.</i></p>	<input checked="" type="checkbox"/> A	60	72		70	76	80	85	95	105	118	-	-	-	4	4

4.144 Illustrations do not correspond to the door finishes.

Single modules for raised dishwashers

Unit without worktop and plinth, carcass depth 560 mm. Order worktop separately.

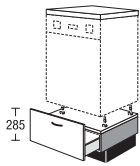
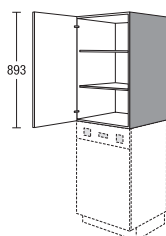
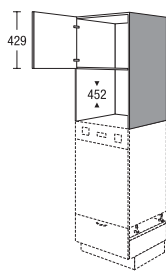
						Price group											
		width				1	2	3	4	5	6	7	Servosoft	Pro Servosoft	ProServoGlass	Soft closing Top Motion	Soft closing Top Motion Plus
 <p>Modular unit for raised dishwasher Set comprising: 1 plinth platform with 1 drip tray, silver grey 1 base unit 147 mm high with 1 drawer 285 mm high</p> <p><i>Order dishwasher front panel and highboard cover separately.</i></p> <p><i>Max. appliance height 836 mm Not suitable for XXL appliances Please check whether dishwasher is approved for raised installation.</i></p> <p><i>The delivery comprises several packages.</i></p> <p><i>Not available for the following ranges: IP 4820, IP 7500</i></p> <p><i>Strip handles 740, 760, 780, 790 and 800 not possible.</i></p>	US	60	29	GS	108	117	127	137	166	178	195	5	8	8	-	-	
	<p>Modular unit for raised dishwasher</p> <p>same as above, but 1 base unit 147 mm high with 1 drawer 285 mm high, 400 mm deep</p>	US	60	29	K1GS	128	131	132	134	140	142	147	-	4	12	-	-
 <p>Dresser unit 899 mm (1619 highboard height) as top unit on electrical appliances</p> <p>1 hinged door 2 adjustable shelves</p> <p><i>Bottom shelf white.</i></p> <p><i>Can only be installed between modular panels or units.</i></p>	<input checked="" type="checkbox"/>	A	60	90	96	103	110	116	130	145	162	-	-	-	4	4	
 <p>Dresser unit Recess height 452 mm as top unit on electrical appliances</p> <p>1 hinged door 1 metal shelf</p> <p><i>Bottom shelf white.</i></p> <p><i>Can only be installed between modular panels or units.</i></p>		AM		90	142	152	163	172	192	214	240	-	-	-	4	4	

Illustrations do not correspond to the door finishes.

Single modules for raised dishwashers

Unit without worktop and plinth, carcass depth 560 mm. Order worktop separately.

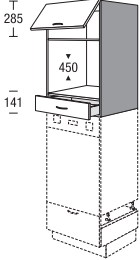
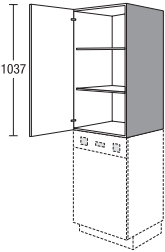
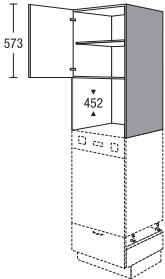
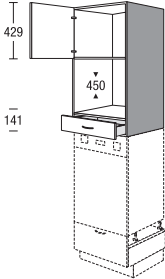
		width	Price group							Servosoft	Pro Servosoft	ProServoGlass	Soft closing Top Motion	Soft closing Top Motion Plus	
			1	2	3	4	5	6	7						
 <p>Dresser unit Niche height 450 mm as top unit on electrical appliances</p> <p>1 flap door 1 drawer</p> <p><i>Bottom shelf white.</i></p> <p><i>Can only be installed between modular panels or units.</i></p>	AMS	90	K	128	138	146	155	174	193	216	5	8	8	4	4
 <p>Dresser unit as top unit on electrical appliances</p> <p>1 hinged door 2 adjustable shelves</p> <p><i>Bottom shelf white.</i></p> <p><i>Can only be installed between modular panels or units.</i></p>	<input checked="" type="checkbox"/> A	60	104	119	128	136	144	163	181	212	-	-	-	4	4
 <p>Dresser unit Recess height 452 mm as top unit on electrical appliances</p> <p>1 hinged door 1 metal shelf</p> <p><i>Can only be installed between modular panels or units.</i></p> <p><i>Bottom shelf white.</i></p>	AM	104		161	173	184	195	221	245	287	-	-	-	4	4
 <p>Dresser unit Niche height 450 mm as top unit on electrical appliances</p> <p>1 hinged door 1 drawer</p> <p><i>Can only be installed between modular panels or units.</i></p> <p><i>Bottom shelf white.</i></p>	AMS	104		140	151	161	170	192	213	239	5	8	8	4	4

4.146 Illustrations do not correspond to the door finishes.

Single modules for raised dishwashers

Unit without worktop and plinth, carcass depth 560 mm. Order worktop separately.

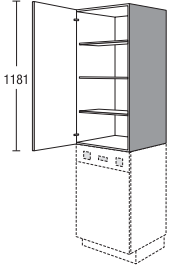
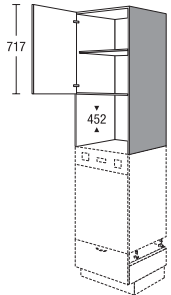
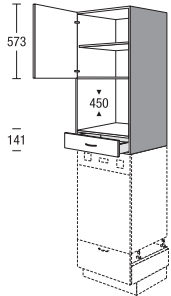
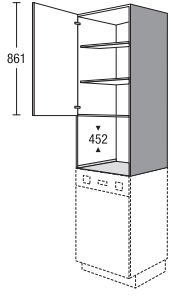
		width	Price group							Servosoft	Pro Servosoft	ProServoglass	Soft closing Top Motion	Soft closing Top Motion Plus	
			1	2	3	4	5	6	7						
 <p>Dresser unit 1187 mm high (height 01) as top unit on electrical appliances</p> <p>1 hinged door 3 adjustable shelves</p> <p><i>Bottom shelf white.</i></p> <p><i>Can only be installed between modular panels or units.</i></p> <p>Illustration shows height 01</p>	A	60	118	131	141	150	159	179	199	233	-	-	-	6	6
	 <p>Dresser unit Recess height 452 mm as top unit on electrical appliances</p> <p>1 hinged door 1 adjustable shelf 1 metal shelf</p> <p><i>Can only be installed between modular panels or units.</i></p> <p><i>Bottom shelf white.</i></p> <p>Illustration shows height 03</p>	AM	118	147	159	168	178	201	223	252	-	-	-	4	4
 <p>Dresser unit Niche height 450 mm as top unit on electrical appliances</p> <p>1 hinged door 1 adjustable shelf 1 drawer</p> <p><i>Can only be installed between modular panels or units.</i></p> <p><i>Bottom shelf white.</i></p> <p>Illustration shows height 03</p>		AMS	118	149	160	170	181	203	226	254	5	8	8	4	4
	 <p>Dresser unit Recess height 452 mm as top unit on electrical appliances</p> <p>1 hinged door 2 adjustable shelves 1 metal shelf</p> <p><i>Can only be installed between modular panels or units.</i></p> <p><i>Bottom shelf white.</i></p> <p>Illustration shows height 03</p>	AM	133	158	171	181	191	216	240	271	-	-	-	4	4

Illustrations do not correspond to the door finishes.

4.147

Single modules for raised dishwashers

Unit without worktop and plinth, carcass depth 560 mm. Order worktop separately.

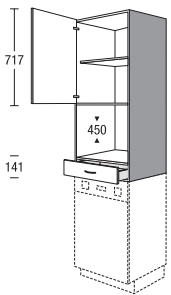
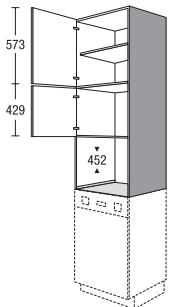
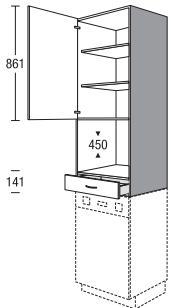
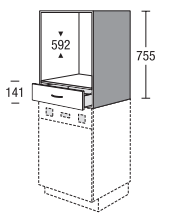
		width	Price group							Servosoft	Pro Servosoft	ProServoGlass	Soft closing Top Motion	Soft closing Top Motion Plus
			1	2	3	4	5	6	7					
 <p>Dresser unit NEW Niche height 450 mm as top unit on electrical appliances</p> <p>1 hinged door 1 adjustable shelf 1 drawer</p> <p><i>Can only be installed between modular panels or units.</i> <i>Bottom shelf white.</i></p>	AMS	133	160	172	183	194	218	243	273	5	8	8	4	4
 <p>Dresser unit NEW Recess height 452 mm as top unit on electrical appliances</p> <p>1 hinged door 1 adjustable shelf 1 hinged door 1 metal shelf</p> <p><i>Can only be installed between modular panels or units.</i> <i>Bottom shelf white.</i></p>	AM	148	170	184	194	206	232	258	291	-	-	-	8	8
 <p>Dresser unit NEW Niche height 450 mm as top unit on electrical appliances</p> <p>1 hinged door 2 adjustable shelves 1 drawer</p> <p><i>Can only be installed between modular panels or units.</i> <i>Bottom shelf white.</i></p>	AMS	148	173	186	197	210	236	262	295	5	8	8	4	4
 <p>Top-mounted unit for oven Niche height 592 mm as dresser unit above dishwasher</p> <p>1 drawer</p> <p><i>matches highboard height 1475 mm</i> <i>Order dishwasher front panel and highboard cover separately.</i> <i>Bottom shelf white.</i></p> <p>Illustration shows 1475 mm height</p>	ABS	75	86	92	97	102	113	123	137	5	8	8	-	-

4.148 Illustrations do not correspond to the door finishes.

5. HANDLELESS / Range C

Product information

Base units

Wall units

Information on tall units for integrated appliances

Highboards, tall units with horizontal recessed grip

Highboards, tall units with vertical recessed grip

Modular panel system

Individual parts, miscellaneous



5. HANDLESS / Range C



Product information

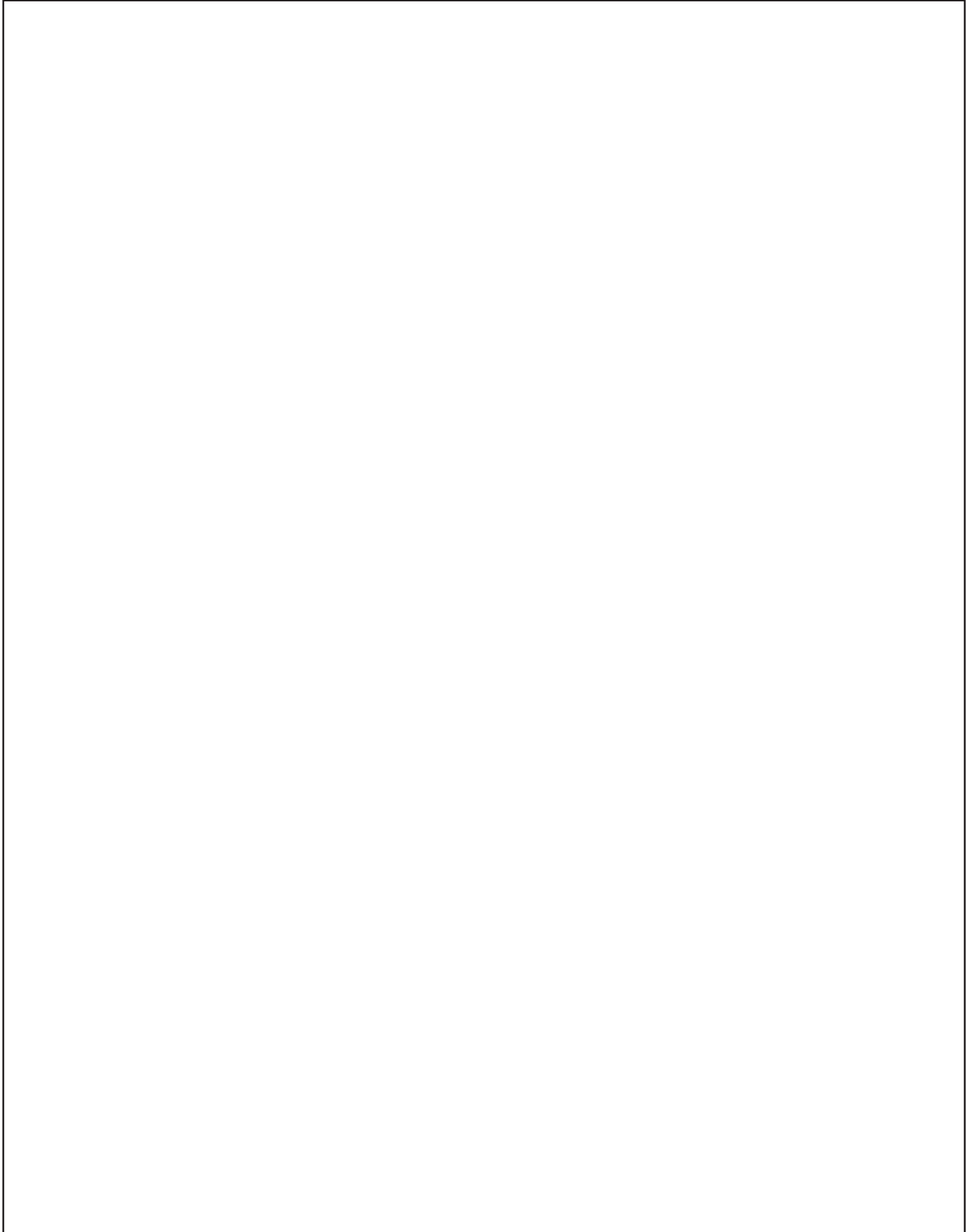



Product information Range C



Irresistible in quality, functionality and form. Our **product range C** satisfies all of the requirements of a modern kitchen and brings with it many advantages.

All smooth fronts are available from us. The possible fronts are marked with the appropriate symbol.
There are no restrictions on carcass decors.

Metal recessed grips are available in the colours stainless steel effect, copper effect, and black and white. In the horizontal planning, the handle profiles directly below the worktop can be fitted with LED lighting.

A genuine added value for our cabinets in **product range C** is the storage space. This gives us more storage space here than in the standard range, which was achieved by changing our carcass height.

The carcass heights of our cabinets in **product range C** are as follows:

- Base units 787 mm (+64 mm)
- Highboards 1507 mm (+32 mm)
- Tall units height 01 1971 mm (+64 mm)
- Tall units height 02 2115 mm (+64 mm)
- Tall units height 03 2259 mm (+64 mm)

The article type in **product range C** is always preceded by the letter C.

We recommend a plinth height of 105 mm so the working height is not too high. The working height (plinth, cabinet and worktop) is then 932 mm (+14 mm on the standard range).

The base and tall units in **product range C** and the highboards need to be drawn forward 16 mm for assembly. We offer a corresponding depth filler in stainless steel effect. An increased carcass depth is also available for an extra charge.

Installation of the handle profile is unique and very easy. Thanks to the new mounting system, the profile does not move once mounted on the unit. Less time is needed for mounting, because mounting is practically without tools.



Product information Range C

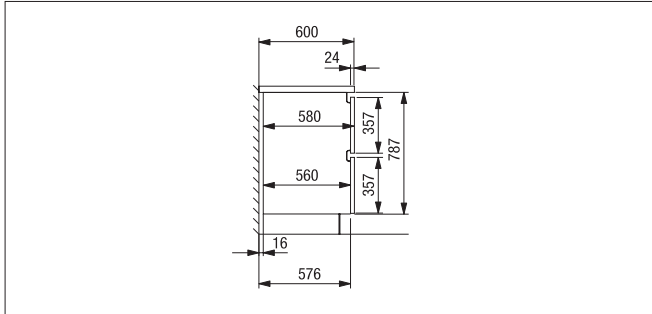

Base units

The base units must be pulled forwards 16 mm from the wall.
The standard worktop depth is 600 mm. The worktop protrusion at a worktop depth of 600 mm is 24 mm (without front).

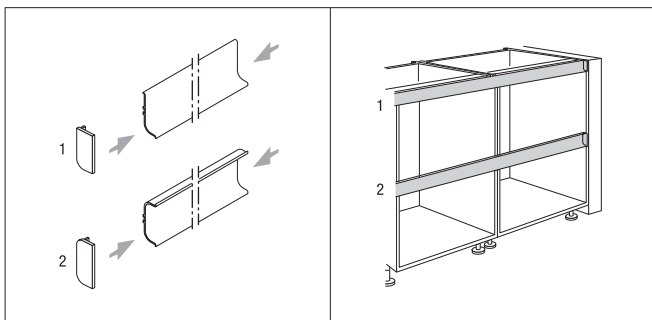

Metal grip ledge profile

The profile is delivered cut to length. End caps and 90° corner connectors are plastic, and match the profile colour. The maximum length of the handle profile is 4000 mm.

Horizontal planning:

The L profile (1) is installed below the worktop. The C profile (2) between the fronts below this.

Vertical planning:

The L profile is needed between panel and highboard / tall unit.
The C profile (2) is installed between highboards / tall units.

The horizontal grip ledge profile and the necessary corner and end caps are included in the unit price.

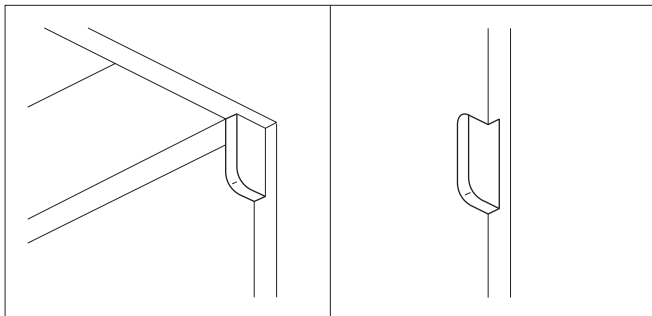

Planning closure with carcass side

The milling is not along the full length of the carcass side.
The handle profile ends in a milled pocket which is milled into the carcass side.

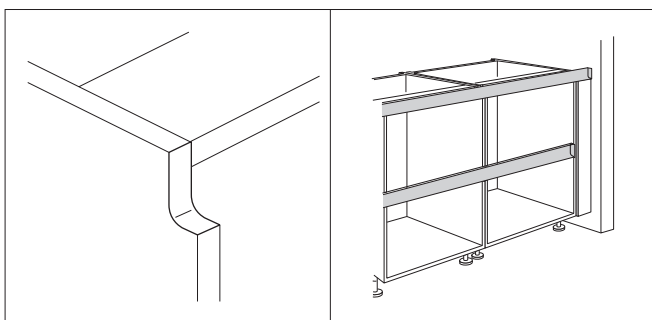

Planning closure with front filler to the wall

The full length of the carcass side is milled.
The L profile below the worktop continues up to the wall. The C profile between 2 fronts ends at the filler panel.

Product information Range C

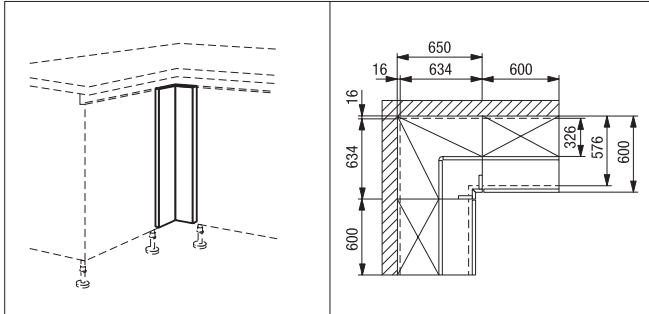

Corner infill panel base units

The planning dimensions for the corner are 650 x 650 mm. The footprint of the filler panel is 634 x 634 mm. Side lengths of 40 - 191 mm are possible. Only angles of 90° are possible.

Corner infill panels are cut and glued. On-site changes are not possible. Please state the planning dimensions when ordering.

When planning dishwashers, use corner filler panel with return pipes.

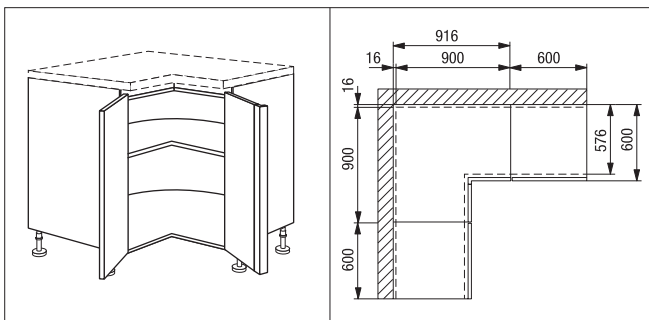

Corner base units

The planning dimensions for corner base units are calculated as follows: corner base unit footprint plus 16 mm (distance between wall and unit).

Corner base units can be delivered as flat packs. Please order item ZUSZERL for this.

With corner base units, the filler panel is installed on site. Only 90° solutions are possible.

When planning dishwashers adjacent to the corner base unit, a panel with return pipes must be ordered.

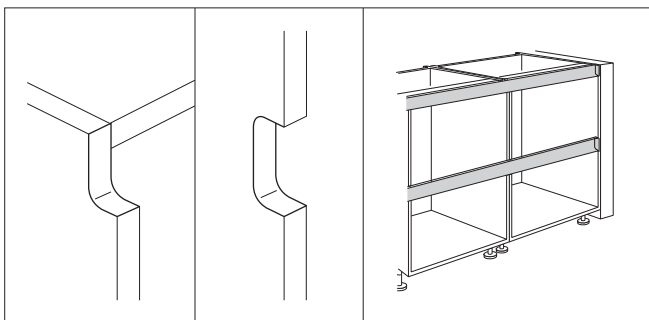

Planning closure with panel

The full length of the carcass side is milled.

The L and C profiles end at the panel.

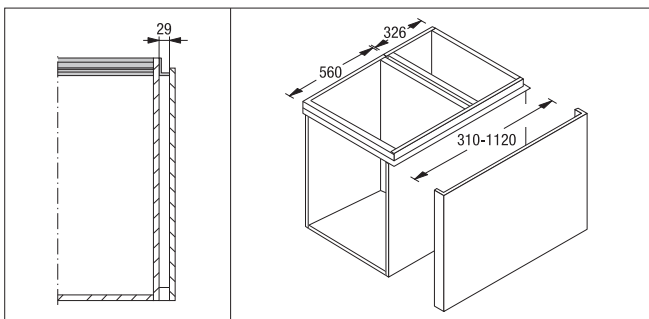

Island solutions with front panels

Use front panels for all-round handle recesses.

The planning dimension of the front panels including the worktop overhang is 53 mm. The depth of the front panels is variable from 310 to 1120 mm in addition to the standard versions.

The anti-tilting device must be fitted on island solutions!

Do not plan front panels directly adjacent to appliances.

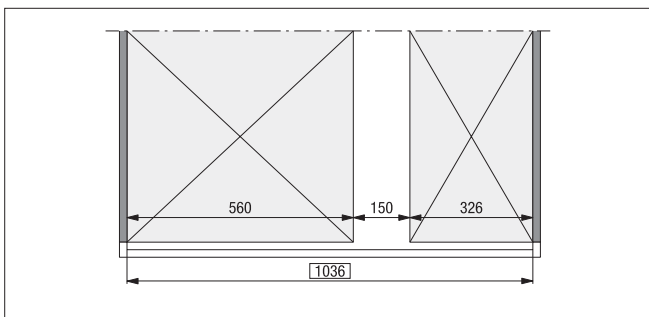

Planning / calculation example front panels:

For the front panels, calculate the desired outer dimension of the carcass. This is the planning dimension for the order.

In the adjacent example, simply add the body depths and any desired space in between (150 mm here). The order dimension for the front panel is then 1036 mm.

Product information Range C

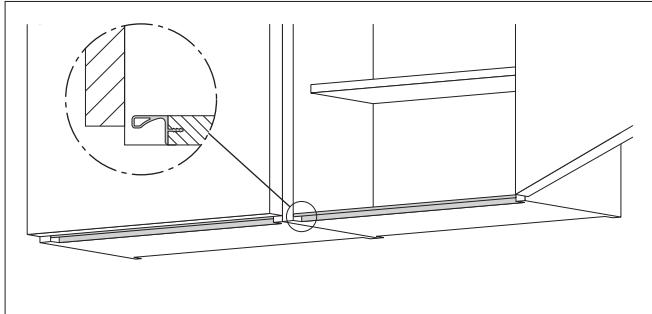

Wall units

Wall units are available in heights 291, 363, 579 (01), 723 (02) and 867 (03) mm. They have a metal handle profile fitted to the carcass base as standard. The metal handle profile for wall units is only available in the colour stainless steel effect.

Wall units from product range C cannot be planned as display wall units.
Include handle profile version 960 stainless-steel effect in planning!

Wall units with hinged doors are available in widths 300, 400, 450, 500 and 600 mm.

Upward folding doors are also available in widths 800, 900 and 1000 mm. Can be combined with cabinets in the standard range. In this case, please also order Tip-On fittings (ZID 251) and without handle and handle drilling for these units where necessary.

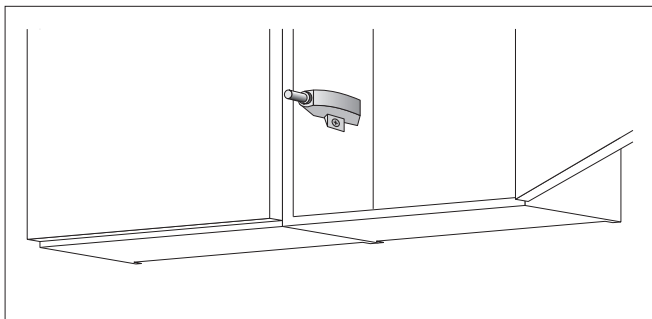

Wall units for cooker hoods

Wall units for cooker hoods are opened with Tip-On fittings (ZID 251). The fitting is already integrated into the respective item and does not have to be ordered separately.

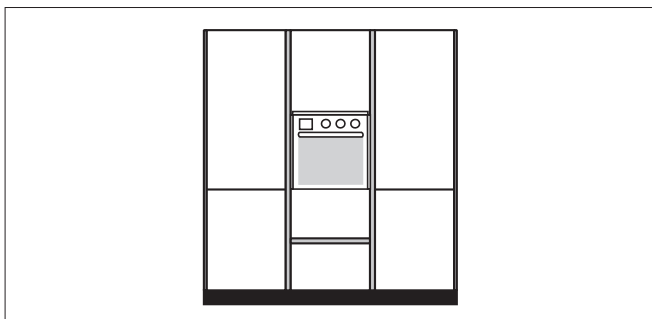

Combination handle profile horizontal/vertical

The combination of the handle profile perfectly unify various tall units. Units can therefore be planned without intermediate panels. Adjacent units are then to be fitted with the L profile.

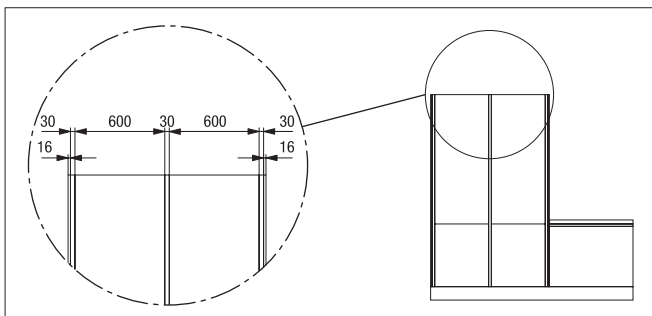

Tall units / highboards with vertical handle profile

Vertical handle profile strips must be planned between consecutive tall units and highboards. The distance between the units is 30 mm.

Product information Range C

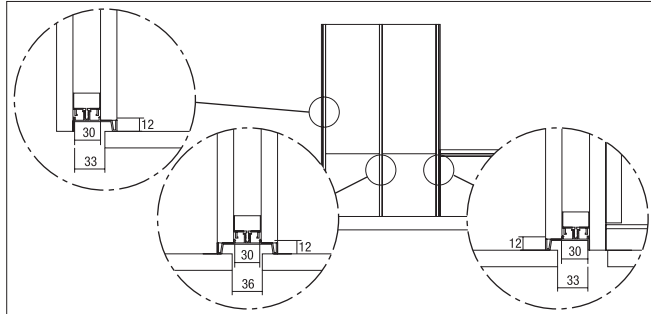

Invisible attachment of the vertical handle profile

The attachment of the vertical handle profiles is not visible in the unit. For easy installation, the units are to be equipped with spacers on the rear carcass side. **Tall units and highboards are also available with horizontal handle profile. These have a special item type and are listed in a separate subsection in the sales manual.**

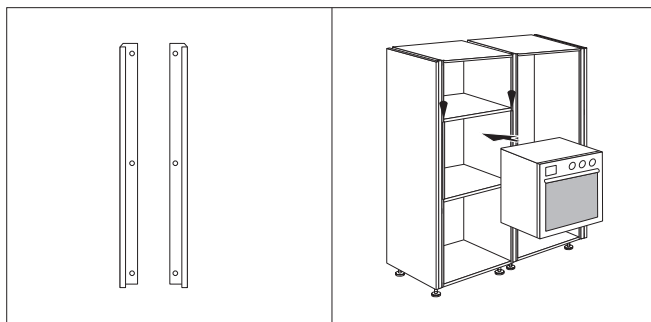

Tall units / highboards with oven aperture

For visual and safety reasons, additional cover strips should be mounted in combination with the vertical handle profile for microwave and oven apertures. A set of cover strips for the microwave and oven aperture (MZCVMW and MZCVBO) is included for a charge and does not need to be factored into the order. The cover profiles are made of metal. Length: cover for microwave aperture 440 mm, length for oven aperture 580 mm. Available colours: stainless steel effect, copper effect, black, white.

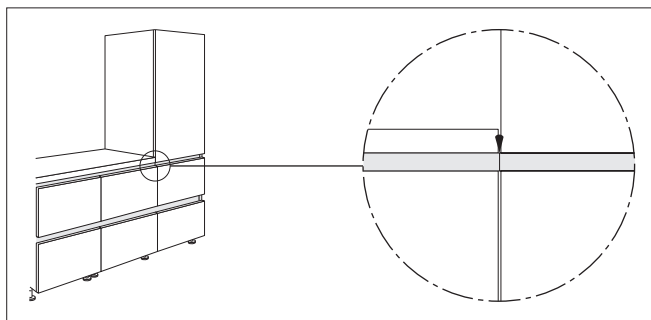

Transition tall unit/highboard to base unit

When planning tall units or highboards directly adjacent to base units, the L profile between the unit transitions is fitted with a butt joint. If this is not desired, we recommend planning a panel between the respective units.

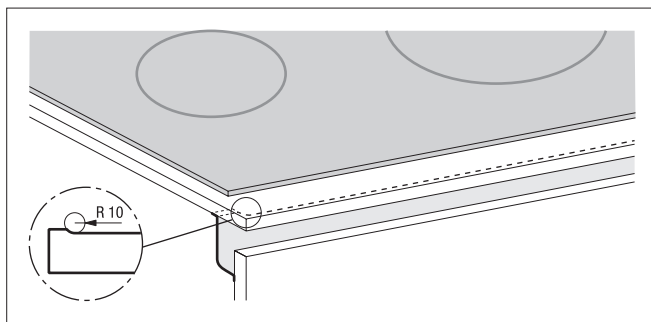

Planning with induction hobs

Some induction hobs require a cutout in the handle profile for air circulation. This is cut out at the factory. Therefore, please specify the appliance type when ordering. The item type CLHFIK must be ordered in addition.

The specification for ventilation to the front is mandatory.

The appliance manufacturers' instructions must also be observed without fail.

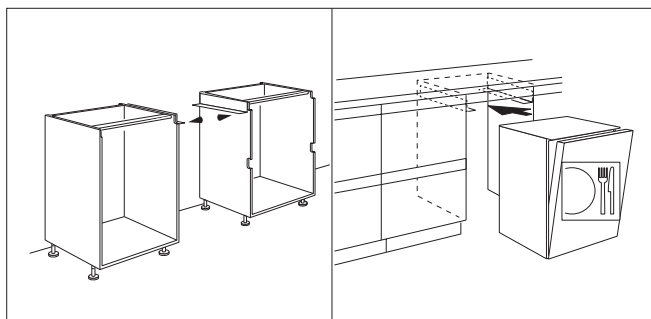

Planning with dishwashers

Only fully integrateable dishwashers are to be planned. The dishwasher is positioned below the worktop with guide brackets. Installing XXL dishwashers is possible above a plinth height of 155 mm. For the front panels for dishwashers (CTGV45 and CTGV60), plastic moisture protectors ZVC449 / ZVC 559 will be included free of charge.

Dimension system Range C

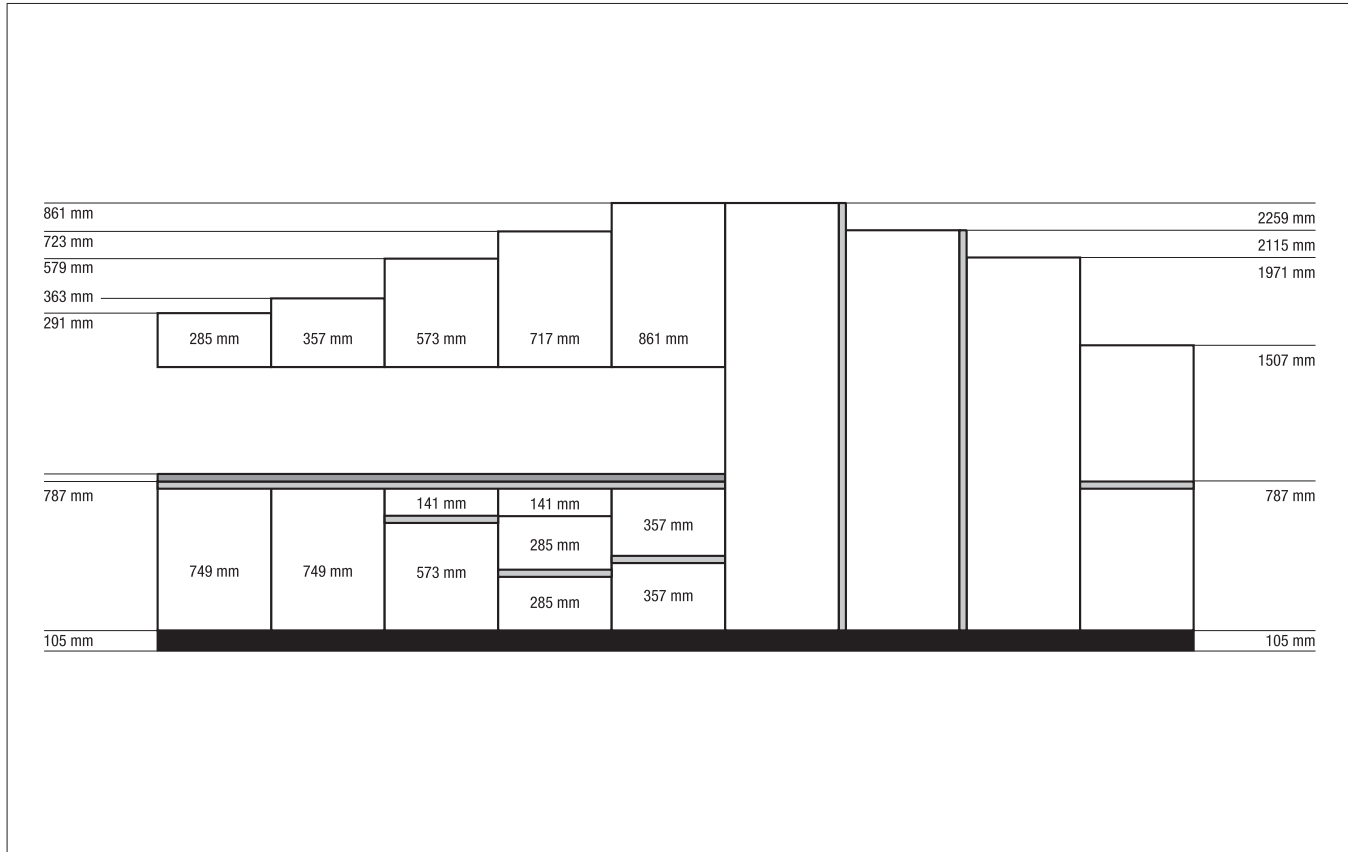

Front dimensions

Kitchens can be optimally planned with our grid system with 141 mm grid size (front drawer panel).
The elegant handle profile of 35 mm (horizontal, visible) meets the high standards expected of consistent, design-oriented planning in every respect.

Various cabinet heights and plinth heights of 105-205 mm allow a working height of 932 to 1032 mm.

Planning options in detail:

Base unit height 787 mm
4 highboard/tall unit heights ranging from 1507 to 2259 mm
4 wall unit heights ranging from 291 to 867 mm
3 plinth heights ranging from 105 to 205 mm

Dimension system Range C



Carcase dimensions

Various unit heights as well as plinth heights of 105 to 205 mm enable a working height of 932 to 1032 mm.

Highboard and tall unit heights of 1507 to 2259 mm fit perfectly into the overall appearance.

Change to the carcass dimensions in comparison to the standard range:

- Base unit: 787 mm (standard range 723 mm: +64 mm)
- Highboard: 1507 mm (standard range 1475 mm: +32 mm)
- Tall unit 01 height: 1971 mm (standard range 1907 mm: +64 mm)
- Tall unit 02 height: 2115 mm (standard range 2051 mm: +64 mm)
- Tall unit 03 height: 2259 mm (standard range 2195 mm: +64 mm)

Notes

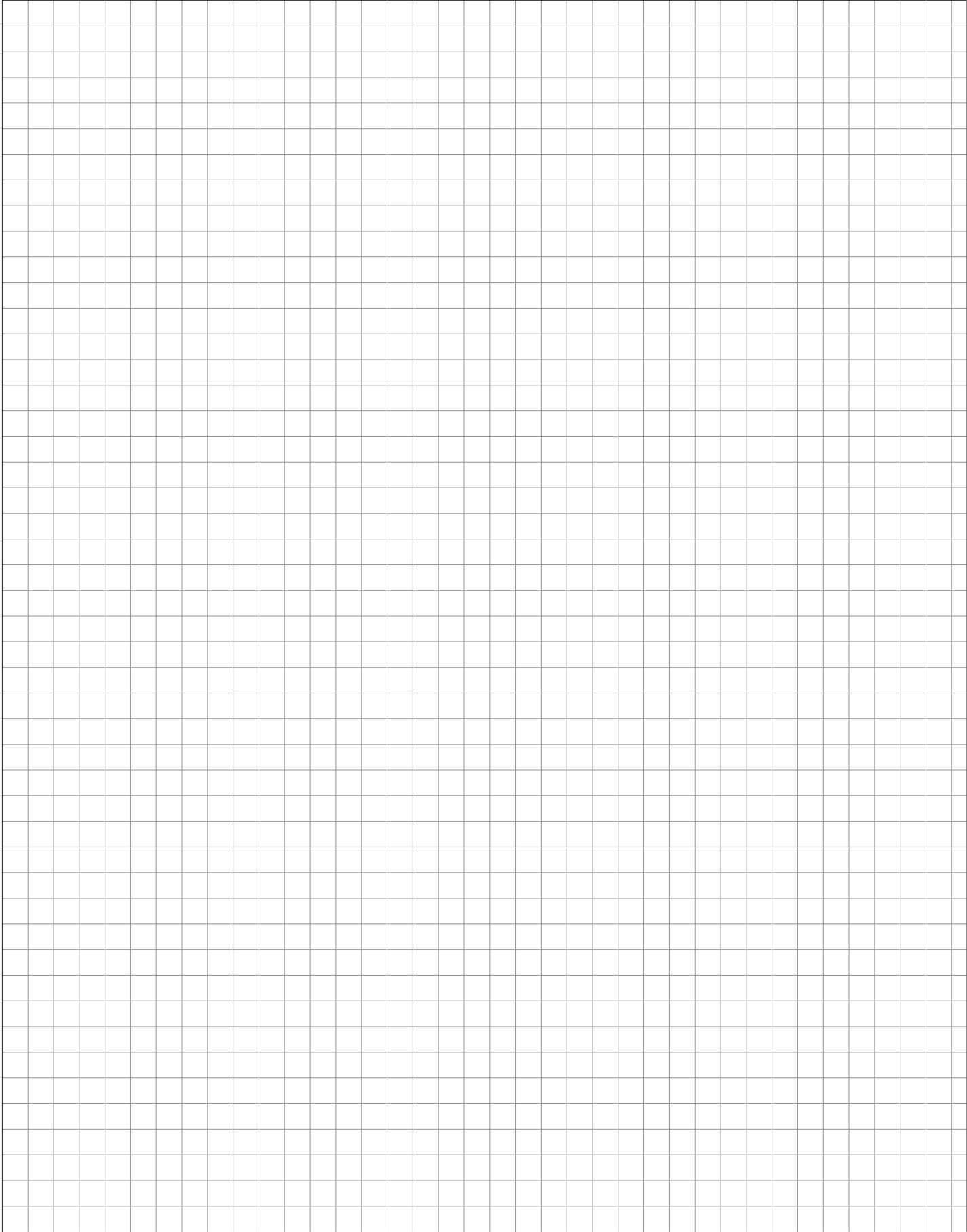

Base units

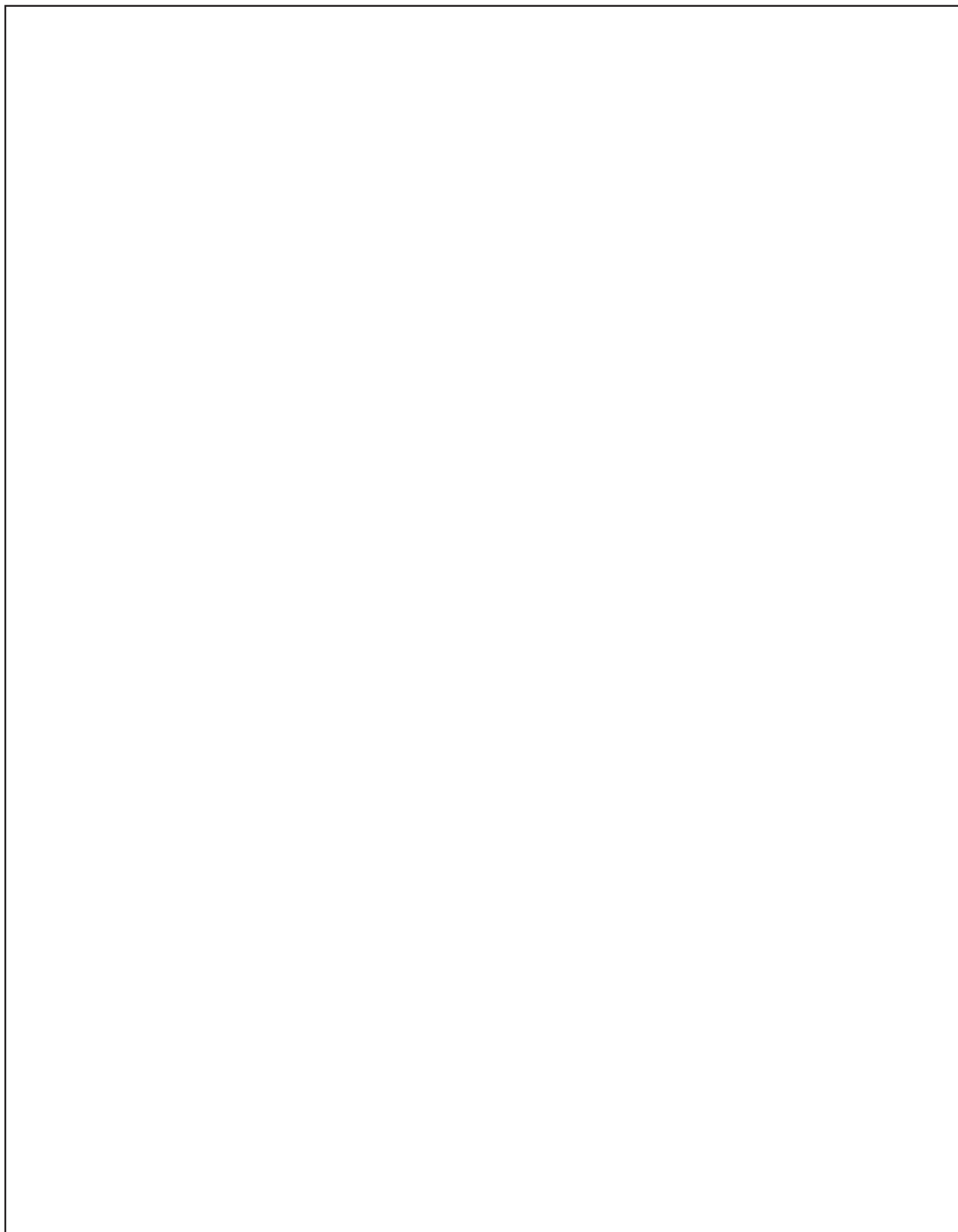

Base units



Base units

Planning information for hob base units

For safety reasons, it is essential to fit a heat shield for conventional hobs and induction hobs if the appliance in question does not have its own heat shield and is to be fitted in a worktop directly above a drawer, deep drawer or side-hung door.

Batches in range C will also have a cut-out in the handle profile. This will be cut at the factory. Therefore, please specify the appliance type when ordering. Item type CLHFIK must be included in the order.

If planning hobs over a number of cabinets, the neighbouring cabinets must also be fitted with heat shields.

Induction hobs must not be planned over 2-door base units or corner cabinets as it is not possible to adapt the heat shield to these items.

Check the feasibility before using ceramic hobs with heat radiation across semi-corner cabinets.

For safety reasons, hobs may not be fitted over built-under appliances without a heat shield.



Summary of the most used/planned base units

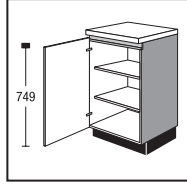

CU30
CU40
CU45
CU50
CU60

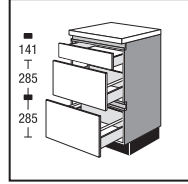

CUS2A30
CUS2A40
CUS2A45
CUS2A50
CUS2A60
CUS2A80
CUS2A90
CUS2A100
CUS2A120

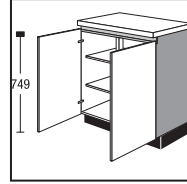

CU80
CU90
CU100
CU120

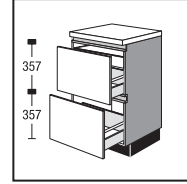

CU2A50IS
CU2A60IS
CU2A80IS
CU2A90IS
CU2A100IS
CU2A120IS

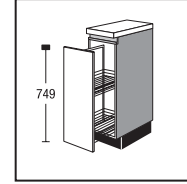

CUA30

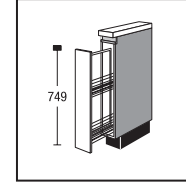

CUA15

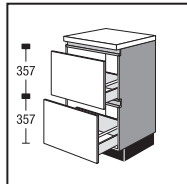

CU2A50
CU2A60
CU2A80
CU2A90
CU2A100
CU2A120

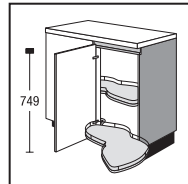

CUE125LM

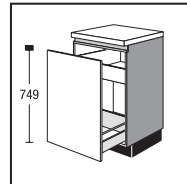

CUA30IS
CUA45IS
CUA50IS
CUA60IS

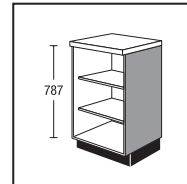

CURV

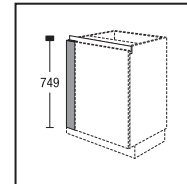

CUPF10
CUPF20

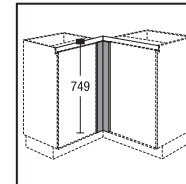

CUPEF65

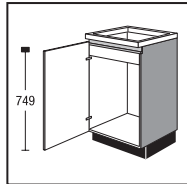

CSP40
CSP45
CSP50
CSP60

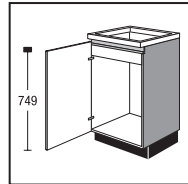

CSP40RW
CSP45RW
CSP50RW
CSP60RW

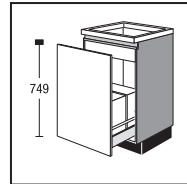

CSPA50M
CSPA60M

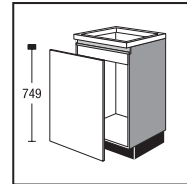

CSP45T
CSP50T
CSP60T

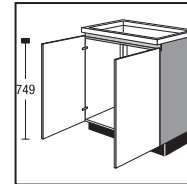

CSP80RW
CSP90RW
CSP100RW
CSP120RW

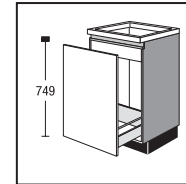

CSPA45
CSPA50
CSPA60

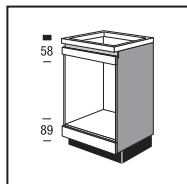

CUHB2

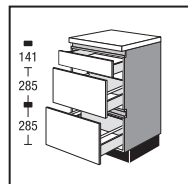

CKIS2A60
CKIS2A80
CKIS2A90
CKIS2A100
CKIS2A120

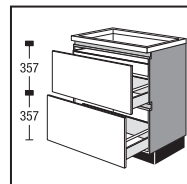

CKI2A60IS
CKI2A80IS
CKI2A90IS
CKI2A100IS
CKI2A120IS

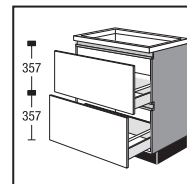

CKD2A60
CKD2A80
CKD2A90
CKD2A100
CKD2A120

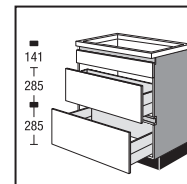

CKDB2A60
CKDB2A80
CKDB2A90
CKDB2A100
CKDB2A120

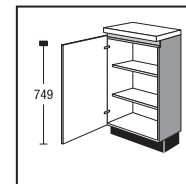

CU307933
CU407933
CU457933
CU507933
CU607933

Legend of symbols used



Depth reduction

Surcharge for depth reduction at the end of the subsection.

Units shortened to the next smallest unit width available.
Example: unit width 600 mm = shortened to 501 mm



Depth reduction

For surcharges and information see register 9 Design elements, special topics, sub-register Surcharges/miscellaneous



Width and depth reduction

Combination of both variants

For surcharges and information see register 9 Design elements, special topics, sub-register Surcharges/miscellaneous



Base unit with carcass depth 326 mm

Plinth feet are supplied loose.

For units with drawer / deep drawer:

- drawer / deep drawer depth 270 mm
- units always with Servosoft

Information on customised products







Please note the possible customisations for cabinets.

The following individualisations are possible:

- Width reduction
- Depth reduction
- Carcase with increased side depth

You will find further information on this under register 9 Design elements, special topics, sub-register Surcharges/miscellaneous.

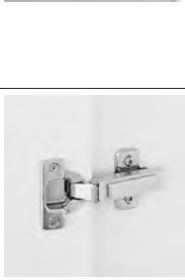
Equipment versions

	<p>Drawers / deep drawers in standard finish TANDEMBOX plus</p> <p>Colour silver grey Version: 506 = full-extension pull-out with Servosoft (allow for surcharge!)</p>
	<p>Drawers / deep drawers Professional (surcharge) TANDEMBOX antaro</p> <p>Colour anthracite Full-extension pull-out with Servosoft Version: 508 = Professional full-extension pull-out with Servosoft</p>
	<p>Drawers / deep drawers Professional with glass side (surcharge) TANDEMBOX antaro</p> <p>Colour anthracite Full-extension pull-out with Servosoft Versions: 510 = Professional with Servosoft and clear glass 512 = Professional with Servosoft and frosted glass</p>
	<p>Non-slip mats (surcharge per unit)</p> <p>All drawers / deep drawers in a batch are fitted with the available non-slip mats</p> <p>Drawer / deep drawer features: Versions: 99 = Without non-slip mat 106 = Non-slip mat in silver-grey 108 = Non-slip mat in anthracite</p>
	<p>Clip hinge, standard version</p> <p>Version 414</p> <p>in combination with a high-quality flap stay</p>
	<p>Cushioning for hinged doors Top Motion (surcharge)</p> <p>Version 418</p> <p>Integrated door cushioning CLIP top BLUMOTION by Blum in combination with a high-quality flap stay</p>
	<p>Cushioning for hinged doors Top Motion (surcharge)</p> <p>Version 428</p> <p>Integrated door cushioning CLIP top BLUMOTION by Blum in combination with AVENTOS HKS flap stay by Blum</p>

Base units

787 mm high

Unit without worktop and plinth, carcass depth 560 mm

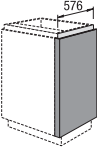
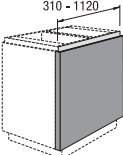
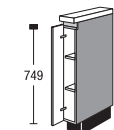
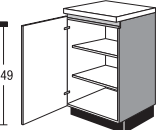









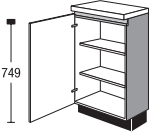





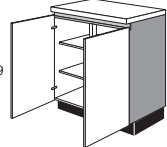



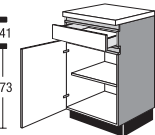





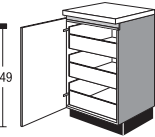





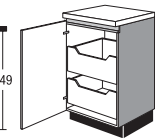





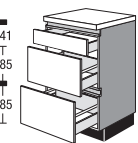









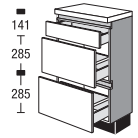

				Price group												
				width	1	2	3	4	5	6	7	ServoSoft	Pro ServoSoft	ProServoGlass	Soft closing Top Motion	Soft closing Top Motion Plus
 <p>Front panel For row ends Front material with recessed grip 576 mm deep for carcass depth 560 mm Planning dimension: 53 mm Do not plan front panels directly adjacent to appliances. Please state carcass depth when ordering.</p>	CWUF53	60		152	155	157	159	170	189	211	-	-	-	-	-	
	CWUF 53	60	CKM	-	-	-	-	-	189	211	-	-	-	-	-	
	CWUF53	V		177	180	182	184	195	214	236	-	-	-	-	-	
	CWUF53	V	CKM	-	-	-	-	-	214	236	-	-	-	-	-	
	CWUF53	V	I	182	185	187	189	200	219	241	-	-	-	-	-	
	CWUF53	V	ICKM	-	-	-	-	-	219	241	-	-	-	-	-	
 <p>Front panel variable in dimensions For island plans Front material with recessed grip Variable for carcass depth 310 - 1120 mm Planning dimension: 53 mm Do not plan front panels directly adjacent to appliances. Please state carcass depth when ordering.</p>	CWUF53	93	I	163	166	168	170	181	200	222	-	-	-	-	-	
	CWUF 53	93	ICKM	-	-	-	-	-	200	222	-	-	-	-	-	
	CWUF53	93		163	166	168	170	181	200	222	-	-	-	-	-	
	CWUF 53	93	ICKM	-	-	-	-	-	200	222	-	-	-	-	-	
 <p>Base unit 1 hinged door 2 adjustable shelves</p>	CU	15		94	102	107	116	128	140	155	-	-	-	4	4	
	CU	30		72	76	80	84	90	97	106	-	-	-	4	4	
 <p>Base unit 1 hinged door 2 adjustable shelves</p>	CU	40		82	86	89	94	102	108	116	-	-	-	4	4	
	CU	45		82	86	90	95	104	110	117	-	-	-	4	4	
	CU	50		83	88	92	97	106	112	119	-	-	-	4	4	
	CU	60		84	89	94	99	110	112	117	-	-	-	4	4	
	CU	60		84	89	94	99	110	112	117	-	-	-	4	4	

5.12 The anti-tilt device which is supplied automatically must be fitted for room divider versions.

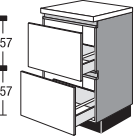
Base units

787 mm high

Unit without worktop and plinth, carcass depth 560 mm











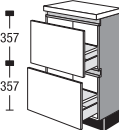

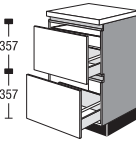

						Price group											
				width		1	2	3	4	5	6	7	Servosoft	Pro Servosoft	ProServoglass	Soft closing Top Motion	Soft closing Top Motion Plus
 <p>Base unit 1 hinged door 2 adjustable shelves <i>Plinth feet are supplied loose.</i></p>		CU	30	79	33	112	116	119	123	130	136	146	-	-	-	4	4
		CU	40	79	33	121	125	129	133	142	148	155	-	-	-	4	4
		CU	45	79	33	124	129	133	137	147	152	160	-	-	-	4	4
		CU	50	79	33	127	133	136	141	150	156	164	-	-	-	4	4
		CU	60	79	33	132	137	142	147	158	160	165	-	-	-	4	4
 <p>Base unit 2 hinged doors 2 adjustable shelves</p>		CU	80			121	132	139	148	164	175	190	-	-	-	8	8
		CU	90			126	136	144	151	168	180	197	-	-	-	8	8
		CU	100			132	138	146	154	173	186	205	-	-	-	8	8
		CU	120			154	161	169	178	198	212	232	-	-	-	8	8
 <p>Base unit 1 drawer 1 hinged door 1 adjustable shelf</p>		CUS	30			81	84	87	92	101	109	120	5	8	8	4	4
		CUS	40			88	93	98	102	114	120	131	5	8	8	4	4
		CUS	45			97	103	108	113	126	133	143	5	8	8	4	4
		CUS	50			100	106	111	116	128	134	144	5	8	8	4	4
		CUS	60			108	114	120	126	142	147	158	5	8	8	4	4
 <p>Base unit with interior drawers 1 hinged door 3 interior drawers <i>When planning next to a wall, the hinged doors must be able to open 90°.</i></p>		CU	30		IS	129	136	142	149	159	164	175	15	24	24	4	4
		CU	40		IS	142	150	156	162	174	179	191	15	24	24	4	4
		CU	45		IS	147	155	161	167	180	184	197	15	24	24	4	4
		CU	50		IS	149	157	164	170	181	187	199	15	24	24	4	4
		CU	60		IS	153	164	170	178	191	197	210	15	24	24	4	4
 <p>Base unit with interior deep drawers 1 hinged door 2 interior deep drawers <i>When planning next to a wall, the hinged doors must be able to open 90°.</i></p>		CU	30		IA	116	122	128	134	145	155	170	10	16	32	4	4
		CU	40		IA	129	136	143	150	164	174	186	10	16	32	4	4
		CU	45		IA	132	139	146	153	168	178	190	10	16	32	4	4
		CU	50		IA	134	144	150	158	174	184	197	10	16	32	4	4
		CU	60		IA	139	149	156	164	182	185	195	10	16	32	4	4
 <p>Base unit 1 drawer 2 deep drawers</p>		CUS2A	30			117	125	132	139	152	163	178	15	24	40	-	-
		CUS2A	40			119	126	133	141	154	164	180	15	24	40	-	-
		CUS2A	45			125	132	138	146	159	169	184	15	24	40	-	-
		CUS2A	50			134	143	150	158	174	184	199	15	24	40	-	-
		CUS2A	60			142	154	160	167	188	200	218	15	24	40	-	-
		CUS2A	80			174	184	193	201	224	239	259	21	30	46	-	-
		CUS2A	90			181	192	200	209	231	246	267	21	30	46	-	-
		CUS2A	100			195	206	215	225	249	265	288	21	30	46	-	-
		CUS2A	120			229	241	250	262	287	304	330	21	30	46	-	-
 <p>Base unit with Servosoft / Pro Servosoft 1 drawer 270 mm deep 2 deep drawers 270 mm deep <i>Plinth feet are supplied loose.</i></p>		CUS2A	30	79	33	158	165	172	180	193	203	218	-	9	25	-	-
		CUS2A	40	79	33	166	173	179	186	199	209	224	-	9	25	-	-
		CUS2A	45	79	33	170	177	183	191	204	214	229	-	9	25	-	-
		CUS2A	50	79	33	172	180	187	195	210	219	233	-	9	25	-	-
		CUS2A	60	79	33	180	191	196	203	223	234	251	-	9	25	-	-
 <p>Base unit 2 deep drawers</p>		CU2A	50			128	138	145	150	170	180	196	10	16	32	-	-
		CU2A	60			135	147	153	160	180	192	209	10	16	32	-	-
		CU2A	80			193	203	211	219	241	256	276	16	22	38	-	-
		CU2A	90			204	214	223	231	254	269	291	16	22	38	-	-
		CU2A	100			215	220	229	238	261	276	301	16	22	38	-	-
		CU2A	120			250	255	260	270	294	309	339	16	22	38	-	-

The anti-tilt device which is supplied automatically must be fitted for room divider versions.

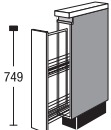
Base units

787 mm high

Unit without worktop and plinth, carcass depth 560 mm





			width	Price group							Servosoft	Pro Servosoft	ProServoGlass	Soft closing Top Motion	Soft closing Top Motion Plus		
				1	2	3	4	5	6	7							
 <p>Base unit with Servosoft / Pro Servosoft</p> <p>2 deep drawers 270 mm deep</p> <p><i>Plinth feet are supplied loose.</i></p>		CU2A	50	79	33	155	166	171	178	196	208	224	-	6	22	-	-
		CU2A	60	79	33	161	172	178	184	204	215	232	-	6	22	-	-
 <p>Base unit with interior drawer</p> <p>1 deep drawer 1 internal drawer 1 deep drawer</p> <p><i>Order carrier for interior drawers separately. Item ZIS 1 (1 unit included)</i></p> <p>Suitable additions:</p> <p>Carrier for interior drawer / interior deep drawer for screwing on the front panel 1 each</p> <p><i>Cannot be used on the following ranges: IP 4820, IP 7500</i></p>		CU2A	50		IS	159	168	177	184	205	207	239	15	24	40	-	-
		CU2A	60		IS	171	181	190	198	221	223	257	15	24	40	-	-
		CU2A	80		IS	216	227	236	245	270	287	309	21	30	46	-	-
		CU2A	90		IS	227	237	245	254	276	294	327	21	30	46	-	-
		CU2A	100		IS	237	246	255	262	283	302	340	21	30	46	-	-
		CU2A	120		IS	271	278	287	292	309	330	384	21	30	46	-	-
 <p>Larder base unit with cushioning</p> <p>1 full-extension pull-out with cushioning, 2 baskets included</p> <p><i>Wire parts silver grey</i></p> <p>hinge L</p>		CUA	15			148	153	159	164	175	186	199	-	-	-	-	-
 <p>Base unit</p> <p>1 deep drawer with 2 drawers</p>		CUA	30		S	96	102	106	112	122	130	141	10	16	16	-	-
		CUA	40		S	112	117	121	128	137	145	157	10	16	16	-	-
 <p>Base unit</p> <p>1 deep drawer with 2 drawers 1 internal drawer</p>		CUA	30		SIS	120	127	133	140	153	163	177	15	24	24	-	-
		CUA	40		SIS	136	142	148	155	167	177	191	15	24	24	-	-

5.14 The anti-tilt device which is supplied automatically must be fitted for room divider versions.

Base units

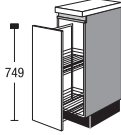
787 mm high

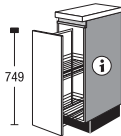
Unit without worktop and plinth, carcass depth 560 mm



		width	Price group							Servosoft	Pro Servosoft	ProServoglass	Soft closing Top Motion	Soft closing Top Motion Plus
			1	2	3	4	5	6	7					
 <p>Larder base unit with cushioning 1 full-extension pull-out with cushioning 2 adjustable baskets <i>Wire parts silver grey</i> <i>R/h hinge = runner on the r/h side</i> <i>L/h hinge = runner on the l/h side</i></p>  <p>Suitable additions:</p> <p>Hanging basket silver-grey 2 each</p>	CUA	30	152	158	163	167	177	186	198	-	-	-	-	-
	ZIK 30 S2		10	10	10	10	10	10	10	-	-	-	-	-
 <p>Base unit Dispensa Junior III 1 full-extension pull-out with cushioning, 2 baskets included <i>Equipment feature baskets: wire parts silver grey</i> <i>Supplementary unit information: Including full pull-out with cushioning</i></p> <p>Note unit information.</p>  <p>Baskets: clip-on baskets silver grey</p> <p>Suitable additions:</p> <p>Insert tray plastic white 12 mm high</p> <p>Hanging basket silver-grey</p>	CUA	30	J	167	174	180	185	196	208	222	-	-	-	-
	ZIE	30		3	3	3	3	3	3	3	-	-	-	-
	ZIK	30		6	6	6	6	6	6	6	-	-	-	-

The anti-tilt device which is supplied automatically must be fitted for room divider versions.

Base units

787 mm high

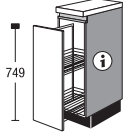
Unit without worktop and plinth, carcass depth 560 mm

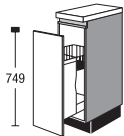
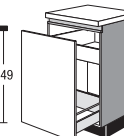
		width	Price group							Servosoft	Pro Servosoft	ProServoGlass	Soft closing Top Motion	Soft closing Top Motion Plus	
			1	2	3	4	5	6	7						
 <p>Base unit Dispensa Junior III 1 full-extension pull-out with cushioning, 2 baskets included</p> <p><i>Basket features:</i> Comfortline, wooden base with metal railing</p> <p><i>Supplementary unit information:</i> Including full pull-out with cushioning</p> <p>Note unit information.</p>  <p>Baskets: wooden shelf and metal rail</p> <p>Suitable additions:</p> <p>Hanging basket Wooden shelf with metal rail</p>	CUA	30	JP	177	184	190	196	208	219	233	-	-	-	-	
	ZIK	30	P	7	7	7	7	7	7	7	7	-	-	-	-
 <p>Base unit for baguettes 1 deep drawer with basket insert and pocket for baguettes</p> <p><i>Wire parts silver grey</i></p> <p><i>Handle arrangement only horizontal</i></p>	CUA	30	B	149	154	159	164	174	183	196	5	8	8	-	-
 <p>Base unit with interior drawer</p> <p>1 deep drawer 1 internal drawer</p> <p><i>Order carrier for interior drawers separately. Item ZIS 1 (1 unit included)</i></p> <p>Suitable additions:</p> <p>Carrier for interior drawer / interior deep drawer for screwing on the front panel 1 each</p> <p><i>Cannot be used on the following ranges: IP 4820, IP 7500</i></p>	<input checked="" type="checkbox"/> CUA	30	IS	97	102	107	113	123	131	142	10	16	24	-	-
	<input checked="" type="checkbox"/> CUA	45	IS	115	119	124	131	141	149	161	10	16	24	-	-
	<input checked="" type="checkbox"/> CUA	50	IS	117	124	129	135	148	154	166	10	16	24	-	-
	<input checked="" type="checkbox"/> CUA	60	IS	118	127	132	137	153	163	177	10	16	24	-	-
	ZIS 1			2	2	2	2	2	2	2	2	-	-	-	-

5.16 The anti-tilt device which is supplied automatically must be fitted for room divider versions.

Base units, Corner base units

787 mm high

Unit without worktop and plinth, carcass depth 560 mm

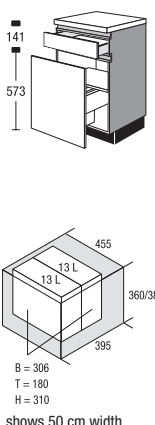
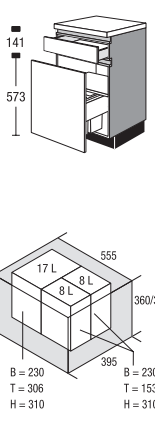
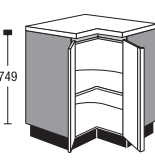
				Price group												
				width	1	2	3	4	5	6	7	Servosoft	Pro Servosoft	ProServoglass	Soft closing Top Motion	Soft closing Top Motion Plus
 <p>Base unit with waste separation system 1 drawer 1 deep drawer 1 cover panel 2 waste bins Capacity 50 cm drawer width 2 containers 13 litres 60 cm drawer width 2 containers 17 litres</p>	CUSA	50	MH2		237	252	256	258	288	300	318	-	6	6	-	-
	CUSA	60	MH2	245	261	265	268	298	310	329	-	6	6	-	-	
 <p>Base unit with waste separation system 1 drawer 1 deep drawer 1 cover panel 3 waste bins Capacity 2 containers 8 litres 1 container 17 litres</p>	CUSA	60	MH3	256	273	276	280	311	324	343	-	6	6	-	-	
	CUE	90		222	232	238	244	250	257	274	-	-	-	8	8	
 <p>Corner base unit 2 hinged doors 1 fixed shelf Planning dimension 916 x 916 mm Unit can be dismantled on site</p>																

The anti-tilt device which is supplied automatically must be fitted for room divider versions.

Corner base units

787 mm high

Unit without worktop and plinth, carcass depth 560 mm

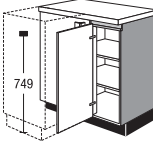
	width	Price group							Servosoft	Pro Servosoft	ProServoGlass	Soft closing Top Motion	Soft closing Top Motion Plus	
		1	2	3	4	5	6	7						
 <p>Corner base unit with smooth add-on panel and loose infill panel, in door finish or door colour for adding base units 1 hinged door 2 adjustable shelves</p> <p><i>Planning dimensions: 905-1100 x 616-650 mm</i> <i>Carcass width 600 mm</i></p> <p><i>The corner infill panel is supplied with returns for kitchens planned with adjacent dishwasher.</i></p> <p><i>An additional infill panel must be ordered for planning dimensions over 650 mm.</i></p> <p><i>Order hinged door opening limited Z19 separately if required.</i></p> <p>Version L</p>	CUE with 30 cm door	95	139	149	158	167	175	188	209	-	-	-	4	4
<p>Corner base unit same as above, but</p> <p><i>Planning dimensions: 1005-1200 x 616-650 mm</i> <i>Carcass width 900 mm</i></p>	CUE with 40 cm door	105	149	158	167	177	184	197	217	-	-	-	4	4
<p>Corner base unit same as above, but</p> <p><i>Planning dimensions: 1055-1250 x 616-650 mm</i> <i>Carcass width 900 mm</i></p>	CUE with 45 cm door	110	153	163	173	182	190	204	225	-	-	-	4	4
<p>Corner base unit same as above, but</p> <p><i>Planning dimensions: 1105-1300 x 616-650 mm</i> <i>Carcass width 1000 mm</i></p>	CUE with 50 cm door	115	154	162	171	180	188	201	222	-	-	-	4	4
<p>Corner base unit same as above, but</p> <p><i>Planning dimensions: 1205-1400 x 616-650 mm</i> <i>Carcass width 1000 mm</i></p>	CUE with 60 cm door	125	154	162	171	180	188	201	222	-	-	-	4	4

5.18 The anti-tilt device which is supplied automatically must be fitted for room divider versions.

Corner base units

787 mm high

Unit without worktop and plinth, carcass depth 560 mm

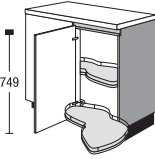
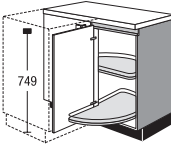
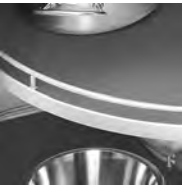
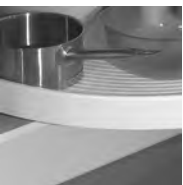
		width	Price group							Servosoft	Pro Servosoft	ProServoglass	Soft closing Top Motion	Soft closing Top Motion Plus	
			1	2	3	4	5	6	7						
 <p>Corner base unit with smooth built-in panel and loose infill panel 50 mm wide in door finish or door colour for adding on base units 1 hinged door 2 fully pivotable wooden carousel shelves with LeMans metal rail with self-closing mechanism and cushioning effect</p> <p><i>Planning dimension 1100 x 650 mm Carcass width 900 mm</i></p> <p><i>May be pulled forward to balance dimensions. (minimum dimension: 1055 x 600 mm)</i></p> <p><i>The corner infill panel is supplied with returns for kitchens planned with adjacent dishwasher.</i></p> <p><i>An additional infill panel must be ordered for planning dimensions over 650 mm.</i></p>	CUE	110	LMP	351	361	368	375	388	402	431	-	-	-	4	4
	<p>Corner base unit same as above, but 2 fully pivotable wooden carousel shelves with LeMans metal rail</p> <p><i>Planning dimension 1100 x 650 mm Carcass width 900 mm</i></p> <p><i>May be pulled forward to balance dimensions. (minimum dimension: 1055 x 600 mm)</i></p>	CUE	110	LM	326	337	345	351	364	377	404	-	-	-	4
 <p>Corner base unit with smooth mounting panel and loose panel 50 mm wide, in door colour for mounting base units 1 hinged door 2 wooden carousel shelves with metal rail</p> <p><i>Planning dimensions: 1105-1300 x 616-650 mm Carcass width 1000 mm</i></p> <p><i>The corner infill panel is supplied with returns for kitchens planned with adjacent dishwasher.</i></p> <p><i>An additional infill panel must be ordered for planning dimensions over 650 mm.</i></p> <p><i>Order hinged door opening limited Z19 separately if required.</i></p> <p>Version L</p> 	CUE	115	KP	220	230	238	245	258	273	296	-	-	-	4	4
	<p>Corner base unit same as above, but 2 laminate swing-out shelves</p> <p>Version L</p> 	CUE	115	K	164	174	181	189	202	216	237	-	-	-	4

The anti-tilt device which is supplied automatically must be fitted for room divider versions.

5.19

Corner base units

787 mm high

Unit without worktop and plinth, carcass depth 560 mm

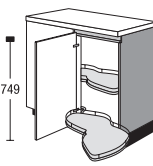
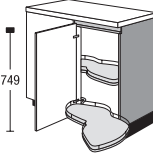
		width	Price group							Servosoft	Pro Servosoft	ProServoGlass	Soft closing Top Motion	Soft closing Top Motion Plus	
			1	2	3	4	5	6	7						
 <p>Version L</p> <p>Corner base unit with smooth built-in panel and loose infill panel 50 mm wide in door finish or door colour for adding on base units 1 hinged door 2 fully pivotable wooden carousel shelves with LeMans metal rail</p> <p><i>Planning dimensions: 1105-1300 x 616-650 mm Carcass width 1000 mm</i></p> <p><i>The corner infill panel is supplied with returns for kitchens planned with adjacent dishwasher.</i></p> <p><i>An additional infill panel must be ordered for planning dimensions over 650 mm.</i></p> <p><i>Order hinged door opening limited Z19 separately if required.</i></p>	CUE	115	LM	336	346	355	361	374	388	415	-	-	-	4	4
	<p>Corner base unit same as above, but 2 fully pivotable wooden carousel shelves with LeMans metal rail with self-closing mechanism and cushioning effect</p>	CUE	115	LMP	360	370	378	385	399	413	442	-	-	-	4
 <p>Version L</p> <p>Corner base unit with smooth built-in panel and loose infill panel 50 mm wide in door finish or door colour for adding on base units 1 hinged door 2 fully pivotable wooden carousel shelves with LeMans metal rail</p> <p><i>Planning dimensions: 1205-1400 x 616-650 mm Carcass width 1000 mm</i></p> <p><i>The corner infill panel is supplied with returns for kitchens planned with adjacent dishwasher.</i></p> <p><i>An additional infill panel must be ordered for planning dimensions over 650 mm.</i></p> <p><i>Order hinged door opening limited Z19 separately if required.</i></p>	CUE	125	LM	344	354	363	370	384	399	427	-	-	-	4	4
	<p>Corner base unit same as above, but 2 fully pivotable wooden carousel shelves with LeMans metal rail with self-closing mechanism and cushioning effect</p>	CUE	125	LMP	368	379	387	395	408	423	452	-	-	-	4

5.20 The anti-tilt device which is supplied automatically must be fitted for room divider versions.

Shelf units

787 mm high

Unit without worktop and plinth, carcass depth 560 mm



Base shelf unit

2 adjustable shelves

Finish in carcass material

Please indicate desired width (150-600 mm).

Not available in visible side colours.



CUR

width

Price group

1	2	3	4	5	6	7
---	---	---	---	---	---	---

Servosoft
Pro Servosoft
ProServoGlass
Soft closing Top Motion
Soft closing Top Motion Plus

130	130	130	130	130	130	130
-----	-----	-----	-----	-----	-----	-----

-	-	-	-	-	-	-
---	---	---	---	---	---	---

The anti-tilt device which is supplied automatically must be fitted for room divider versions.

5.21

Oven housing units / hob units

787 mm high

Unit without worktop and plinth, carcass depth 560 mm

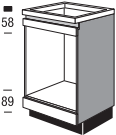
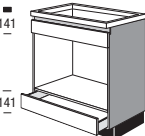
		width	Price group							Servosoft	Pro Servosoft	ProServoGlass	Soft closing Top Motion	Soft closing Top Motion Plus
			1	2	3	4	5	6	7					
 <p>Base unit for built-under oven</p> <p>Aperture dimensions: 599 mm high, max. 568 mm wide, 560 mm deep</p> <p>2 fixed front panels</p> <p><i>Oven model must be indicated</i></p> <p><i>Please state worktop thickness</i></p> <p><i>The specification for ventilation to the front is mandatory.</i></p> <p><i>For foil-wrapped fronts a set of heat deflector plates are supplied free of charge.</i></p>	CUHB	2	97	100	102	104	106	110	118	-	-	-	-	-
	<p>Surcharge for recessed grip milling for induction hobs</p> <p>For ventilation below the worktop</p> <p><i>Specify appliance type</i></p>	CLHFIK		8	8	8	8	8	8	8	-	-	-	-
 <p>Base unit for built-under oven</p> <p>Aperture dimensions: 464-494 mm high max. 868 mm wide, 560 mm deep</p> <p>1 fixed front panel 1 drawer</p> <p><i>Front panel must be cut to size on-site.</i></p> <p><i>Specify appliance type</i></p> <p><i>Please state worktop thickness</i></p> <p><i>The specification for ventilation to the front is mandatory.</i></p>	CUMBS	90	181	190	196	204	217	222	232	5	8	8	-	-
	<p>Surcharge for recessed grip milling for induction hobs</p> <p>For ventilation below the worktop</p> <p><i>Specify appliance type</i></p>	CLHFIK		8	8	8	8	8	8	8	-	-	-	-

5.22 The anti-tilt device which is supplied automatically must be fitted for room divider versions.

Oven housing units / hob units

787 mm high

Unit without worktop and plinth, carcass depth 560 mm

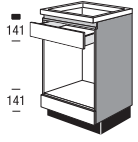
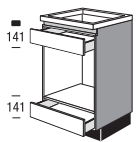
		width	Price group							Servosoft	Pro Servosoft	ProServoglass	Soft closing Top Motion	Soft closing Top Motion Plus
			1	2	3	4	5	6	7					
 <p>Base unit for microwave oven Niche sizes: 450 mm high, max. 568 mm wide, 560 mm deep</p> <p>1 drawer 1 cable protection shelf 1 fixed front panel</p> <p><i>Please state worktop thickness</i></p> <p><i>Specify appliance type</i></p> <p><i>The specification for ventilation to the front is mandatory.</i></p>	CKIMSB	122	129	133	139	149	152	160	5	8	8	-	-	
	<p>Surcharge for recessed grip milling for induction hobs For ventilation below the worktop</p> <p><i>Specify appliance type</i></p>	CLHFIK	8	8	8	8	8	8	8	-	-	-	-	-
 <p>Base unit for microwave oven Niche sizes: 450 mm high, max. 568 mm wide, 560 mm deep</p> <p>2 drawers 1 cable protection shelf</p> <p><i>Please state worktop thickness</i></p> <p><i>Specify appliance type</i></p> <p><i>The specification for ventilation to the front is mandatory.</i></p>	CKIM2S	149	156	161	167	177	180	189	10	16	16	-	-	
	<p>Surcharge for recessed grip milling for induction hobs For ventilation below the worktop</p> <p><i>Specify appliance type</i></p>	CLHFIK	8	8	8	8	8	8	8	-	-	-	-	-

The anti-tilt device which is supplied automatically must be fitted for room divider versions.

Hob base units optimised for induction and conventionally heated hobs

787 mm high

Unit without worktop and plinth, carcass depth 560 mm

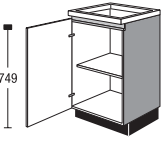
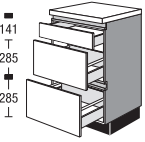
		width	Price group							Servosoft	Pro Servosoft	ProServoGlass	Soft closing Top Motion	Soft closing Top Motion Plus	
			1	2	3	4	5	6	7						
 <p>Hob base unit 1 hinged door 1 cable protection shelf 1 adjustable shelf</p> <p><i>Specify appliance type</i> Please state worktop thickness The specification for ventilation to the front is mandatory.</p>	CKI	40	87	90	95	101	112	117	125	-	-	-	4	4	
	CKI	45	88	91	97	102	114	118	127	-	-	-	4	4	
	CKI	50	89	95	100	104	116	120	129	-	-	-	4	4	
	CKI	60	91	97	102	108	122	129	138	-	-	-	4	4	
<p>Surcharge for recessed grip milling for induction hobs For ventilation below the worktop <i>Specify appliance type</i></p>	CLHFIK		8	8	8	8	8	8	8	-	-	-	-	-	
	 <p>Hob base unit 1 drawer 1 cable protection shelf 2 deep drawers</p> <p><i>Specify appliance type</i> Please state worktop thickness 40 mm clearance to bottom edge of worktop. During planning and installation, it is essential to observe the safety distances of the electrical appliance manufacturer! The specification for ventilation to the front is mandatory.</p>	CKIS2A	60	171	183	190	197	219	232	252	15	24	40	-	-
		CKIS2A	80	224	235	245	255	280	297	321	21	30	46	-	-
		CKIS2A	90	232	244	254	263	289	306	331	21	30	46	-	-
CKIS2A		100	247	260	271	282	310	329	349	21	30	46	-	-	
CKIS2A		120	274	289	301	313	344	365	381	21	30	46	-	-	
<p>Surcharge for recessed grip milling for induction hobs For ventilation below the worktop <i>Specify appliance type</i></p>	CLHFIK		8	8	8	8	8	8	8	-	-	-	-	-	

5.24 The anti-tilt device which is supplied automatically must be fitted for room divider versions.

Hob base units optimised for induction and conventionally heated hobs

787 mm high

Unit without worktop and plinth, carcass depth 560 mm

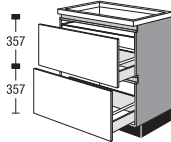
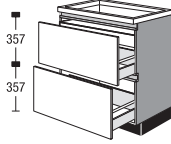
		width	Price group							Servosoft	Pro Servosoft	ProServoglass	Soft closing Top Motion	Soft closing Top Motion Plus		
			1	2	3	4	5	6	7							
 <p>Hob base unit 1 deep drawer 1 cable protection shelf 1 deep drawer</p> <p>40 mm clearance to bottom edge of worktop. Please state worktop thickness</p> <p>Specify appliance type</p> <p>During planning and installation, it is essential to observe the safety distances of the electrical appliance manufacturer!</p> <p>The specification for ventilation to the front is mandatory.</p>	CKI2A	60		156	166	175	183	206	221	241	10	16	32	-	-	
		CKI2A	80		197	207	215	224	244	259	280	16	22	38	-	-
		CKI2A	90		207	217	226	234	257	272	293	16	22	38	-	-
		CKI2A	100		218	223	232	241	264	279	304	16	22	38	-	-
		CKI2A	120		243	248	253	262	288	303	332	16	22	38	-	-
		CLHFIK			8	8	8	8	8	8	8	-	-	-	-	-
<p>Surcharge for recessed grip milling for induction hobs</p> <p>For ventilation below the worktop</p> <p>Specify appliance type</p>																
 <p>Hob base unit 1 deep drawer 1 cable protection shelf 1 internal drawer 1 deep drawer</p> <p>Please state worktop thickness</p> <p>40 mm clearance to bottom edge of worktop.</p> <p>Specify appliance type</p> <p>During planning and installation, it is essential to observe the safety distances of the electrical appliance manufacturer!</p> <p>The specification for ventilation to the front is mandatory.</p>	CKI2A	60	IS	178	189	199	209	234	251	274	15	24	40	-	-	
		CKI2A	80	IS	221	231	242	251	274	291	313	21	30	46	-	-
		CKI2A	90	IS	233	245	255	264	290	306	331	21	30	46	-	-
		CKI2A	100	IS	245	259	268	277	305	321	349	21	30	46	-	-
		CKI2A	120	IS	273	286	298	307	340	355	389	21	30	46	-	-
		CLHFIK			8	8	8	8	8	8	8	-	-	-	-	-
<p>Surcharge for recessed grip milling for induction hobs</p> <p>For ventilation below the worktop</p> <p>Specify appliance type</p>																
<p>Suitable additions:</p>																
<p>Carrier for interior drawer / interior deep drawer</p> <p>for screwing on the front panel 1 each</p> <p>Cannot be used on the following ranges: IP 4820, IP 7500</p>		ZIS 1		2	2	2	2	2	2	2	-	-	-	-	-	

The anti-tilt device which is supplied automatically must be fitted for room divider versions.

5.25

Hob base units for hob extractors

787 mm high

Unit without worktop and plinth, carcass depth 560 mm

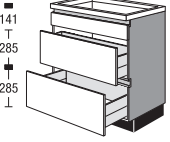
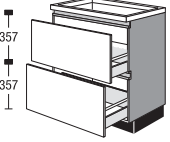
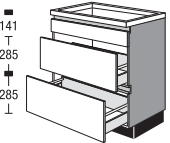
		width	Price group							Servosoft	Pro Servosoft	ProServoGlass	Soft closing Top Motion	Soft closing Top Motion Plus	
			1	2	3	4	5	6	7						
 <p>Hob base unit for hob extractor</p> <p>1 fixed front panel 1 deep drawer 1 deep drawer (reduced in depth depending on appliance) NEW</p> <p><i>Specify appliance type</i></p> <p><i>Please state worktop thickness</i></p> <p><i>Depending on appliance, an adjustment must be made on site.</i></p> <p><i>The specification for ventilation to the front is mandatory.</i></p> <p><i>We cannot accept responsibility for swelling damage due to circulating air mode.</i></p>	CKDB2A	60		181	191	198	206	227	241	258	10	16	32	-	-
	CKDB2A	80		187	197	206	214	236	251	271	16	22	38	-	-
	CKDB2A	90		189	199	208	216	239	254	274	16	22	38	-	-
	CKDB2A	100		202	213	222	231	256	272	292	16	22	38	-	-
	CKDB2A	120		230	242	251	261	289	306	327	16	22	38	-	-
 <p>Hob base unit for hob extractor</p> <p>1 deep drawer (reduced in depth depending on appliance) 1 fixed inside panel 1 deep drawer (reduced in depth depending on appliance)</p> <p><i>Specify appliance type</i></p> <p><i>Please state worktop thickness</i></p> <p><i>Depending on appliance, an adjustment must be made on site.</i></p> <p><i>The specification for ventilation to the front is mandatory.</i></p> <p><i>We cannot accept responsibility for swelling damage due to circulating air mode.</i></p>	CKD2A	60		177	186	193	200	220	234	250	10	16	32	-	-
	CKD2A	80		182	193	200	209	229	244	263	16	22	38	-	-
	CKD2A	90		184	195	202	211	232	247	266	16	22	38	-	-
	CKD2A	100		197	209	216	226	249	265	285	16	22	38	-	-
	CKD2A	120		225	238	245	256	282	299	320	16	22	38	-	-
 <p>Hob base unit for hob extractor NEW</p> <p>with full-height back panel NEW</p> <p>1 fixed front panel NEW</p> <p>1 deep drawer NEW</p> <p>1 deep drawer NEW</p> <p><i>Specify appliance type</i></p> <p><i>Please state worktop thickness</i></p> <p><i>Depending on appliance, an adjustment must be made on site.</i></p> <p><i>The specification for ventilation to the front is mandatory.</i></p> <p><i>We cannot accept responsibility for swelling damage due to circulating air mode.</i></p> <p><i>Appliance must be suitable for non-ducted recirculating air.</i></p>	CKDB2A	60	U	181	191	198	206	227	241	258	10	16	32	-	-
	CKDB2A	80	U	187	197	206	214	236	251	271	16	22	38	-	-
	CKDB2A	90	U	189	199	208	216	239	254	274	16	22	38	-	-
	CKDB2A	100	U	202	213	222	231	256	272	292	16	22	38	-	-
	CKDB2A	120	U	230	242	251	261	289	306	327	16	22	38	-	-

5.26 The anti-tilt device which is supplied automatically must be fitted for room divider versions.

Hob base units for hob extractors

787 mm high

Unit without worktop and plinth, carcass depth 560 mm

		width	Price group							Servosoft	Pro Servosoft	ProServoglass	Soft closing Top Motion	Soft closing Top Motion Plus		
			1	2	3	4	5	6	7							
 <p>Hob base unit for hob extractor</p> <ul style="list-style-type: none"> with full-height back panel 1 deep drawer 1 fixed inside panel 1 deep drawer <p><i>Specify appliance type</i></p> <p><i>Please state worktop thickness</i></p> <p><i>Depending on appliance, an adjustment must be made on site.</i></p> <p><i>The specification for ventilation to the front is mandatory.</i></p> <p><i>We cannot accept responsibility for swelling damage due to circulating air mode.</i></p> <p><i>Appliance must be suitable for non-ducted recirculating air.</i></p>	NEW	CKD2A	60	U	177	186	193	200	220	234	250	10	16	32	-	-
	NEW	CKD2A	80	U	182	193	200	209	229	244	263	16	22	38	-	-
	NEW	CKD2A	90	U	184	195	202	211	232	247	266	16	22	38	-	-
	NEW	CKD2A	100	U	197	209	216	226	249	265	285	16	22	38	-	-
	NEW	CKD2A	120	U	225	238	245	256	282	299	320	16	22	38	-	-

The anti-tilt device which is supplied automatically must be fitted for room divider versions.

Decor panels and front panels, Sink base units

787 mm high

Unit without worktop and plinth, carcass depth 560 mm

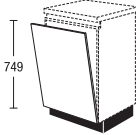
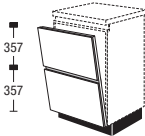
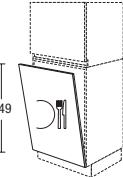
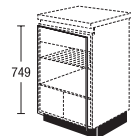
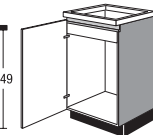
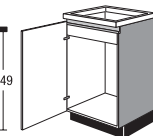
		width		Price group							Servosoft	Pro Servosoft	ProServoGlass	Soft closing Top Motion	Soft closing Top Motion Plus
				1	2	3	4	5	6	7					
 <p>Front panel for fully integrated built-under dishwashers incl. support brackets and moisture protectors <i>Specify appliance type Maximum appliance height 834 mm with plinth height 105 mm</i></p>	CTGV	45		36	39	41	44	51	55	61	-	-	-	-	-
	CTGV	60		37	41	43	46	52	58	67	-	-	-	-	-
 <p>Front panel with split front and handle profile for fully integrated built-under dishwashers incl. support brackets and moisture protectors 1 spacer frame in stainless steel effect <i>Specify appliance type Maximum appliance height 834 mm with plinth height 105 mm</i> <i>When planning a split effect dishwasher front, the run of units needs to be pulled 30 mm forward from the wall.</i> <i>If planning at the end of a run, an end panel is required next to the dishwasher.</i> <i>Cannot be combined with front panels.</i> <i>We recommend the use of appliances with sliding door technology.</i></p>	CTGV	60	M2	169	173	175	178	184	190	199	-	-	-	-	-
 <p>Front panel for fully integrated dishwashers in combination with top-mounted cabinets, including moisture protectors <i>Specify appliance type Maximum appliance height 834 mm with plinth height 105 mm</i></p>	CTGV	60	S	22	24	26	27	31	34	40	-	-	-	-	-
 <p>Base unit door without stop bar for built-under integrated refrigerators and freezers. <i>Specify appliance type</i></p>	CTK	60	F	37	41	42	44	52	58	67	-	-	-	-	-
 <p>Sink base unit 1 hinged door 1 fixed inside panel</p>	CSP	40		77	80	81	83	89	95	103	-	-	-	4	4
	CSP	45		78	82	85	88	92	97	105	-	-	-	4	4
	CSP	50		80	84	86	90	96	102	111	-	-	-	4	4
	CSP	60		82	87	92	97	109	112	118	-	-	-	4	4
 <p>Sink base unit 1 hinged door 1 fixed inside panel with full-height back panel</p>	CSP	40	RW	86	89	90	92	99	104	113	-	-	-	4	4
	CSP	45	RW	87	91	94	98	102	106	115	-	-	-	4	4
	CSP	50	RW	89	93	96	100	105	111	120	-	-	-	4	4
	CSP	60	RW	91	97	102	106	118	121	128	-	-	-	4	4

5.28 The anti-tilt device which is supplied automatically must be fitted for room divider versions.

Sink base units

787 mm high

Unit without worktop and plinth, carcass depth 560 mm

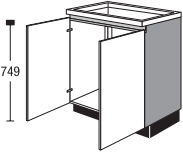
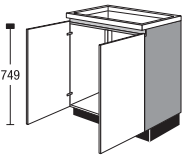
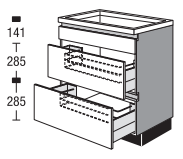
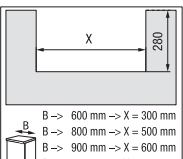
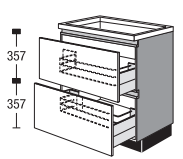
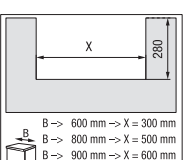
			Price group												
			width								Servosoft	Pro Servosoft	ProServoglass	Soft closing Top Motion	Soft closing Top Motion Plus
				1	2	3	4	5	6	7					
 <p>Sink base unit 2 hinged doors</p>	CSP	80		121	129	135	143	162	172	187	-	-	-	8	8
	CSP	90		122	130	136	144	163	174	189	-	-	-	8	8
	CSP	100		127	135	142	149	168	180	198	-	-	-	8	8
	CSP	120		129	137	144	151	170	182	200	-	-	-	8	8
 <p>Sink base unit 2 hinged doors with full-height back panel</p>	CSP	80	RW	131	138	145	152	171	181	196	-	-	-	8	8
	CSP	90	RW	132	139	146	153	172	183	198	-	-	-	8	8
	CSP	100	RW	136	145	151	159	178	190	208	-	-	-	8	8
	CSP	120	RW	138	147	153	161	180	192	210	-	-	-	8	8
 <p>Sink base unit for Quooker systems 1 fixed front panel 2 deep drawers Deep drawers with cut-out in middle, approx. 275 mm deep</p>	CSPB2A	60	Q	255	269	281	293	324	345	374	10	16	32	-	-
	CSPB2A	80	Q	262	275	287	297	326	346	374	16	22	38	-	-
	CSPB2A	90	Q	280	293	305	315	344	364	393	16	22	38	-	-
	CSPB2A	100	Q	293	306	318	328	357	376	405	16	22	38	-	-
 <p>Sink base unit for Quooker systems 2 deep drawers Deep drawers with cut-out in middle, approx. 275 mm deep</p>	CSP2A	60	Q	257	269	278	289	315	332	360	10	16	32	-	-
	CSP2A	80	Q	265	277	289	299	326	345	372	16	22	38	-	-
	CSP2A	90	Q	283	294	304	314	339	357	384	16	22	38	-	-
	CSP2A	100	Q	295	305	313	323	347	363	388	16	22	38	-	-
	CSP2A	120	Q	329	337	341	351	372	385	408	16	22	38	-	-
	III. shows 90 cm width														
 <p>Sink base unit 1 fixed front panel 1 drawer 285 mm high, 270 mm deep 1 pull-out 270 mm deep</p>	CSPB2A	80	SK2	184	194	201	210	229	243	263	13	19	27	-	-
	CSPB2A	90	SK2	202	211	220	227	248	262	284	13	19	27	-	-
	CSPB2A	100	SK2	212	222	230	238	258	273	293	13	19	27	-	-
 <p>Sink base unit 1 drawer 357 mm high, 270 mm deep 1 fixed infill panel 1 pull-out 270 mm deep</p>	CSP2A	80	SK2	182	191	198	206	224	237	257	13	19	27	-	-
	CSP2A	90	SK2	201	210	216	224	242	254	273	13	19	27	-	-
	CSP2A	100	SK2	211	219	225	232	248	259	278	13	19	27	-	-

The anti-tilt device which is supplied automatically must be fitted for room divider versions.

Sink base units

787 mm high

Unit without worktop and plinth, carcass depth 560 mm

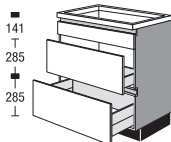
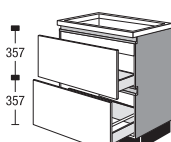
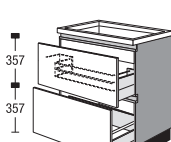
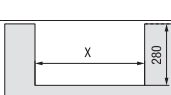
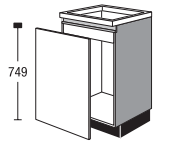
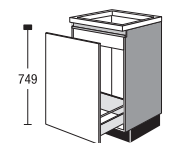
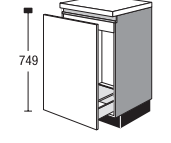

		width		Price group							Servosoft	Pro Servosoft	ProServoGlass	Soft closing Top Motion	Soft closing Top Motion Plus
				1	2	3	4	5	6	7					
 <p>Sink base unit 1 fixed front panel 1 drawer 285 mm high 270 mm deep 1 deep drawer</p>	CSPB2A	60	S	175	185	193	201	223	237	257	10	16	24	-	-
	CSPB2A	80	S	187	196	204	212	233	247	267	13	19	27	-	-
	CSPB2A	90	S	205	214	223	230	252	266	288	13	19	27	-	-
	CSPB2A	100	S	215	225	233	241	262	276	297	13	19	27	-	-
 <p>Sink base unit 1 drawer 270 mm deep 1 deep drawer</p>	CSP2A	60	S	174	182	189	196	213	226	243	10	16	24	-	-
	CSP2A	80	S	185	194	201	209	227	241	260	13	19	27	-	-
	CSP2A	90	S	204	212	219	227	245	258	276	13	19	27	-	-
	CSP2A	100	S	214	222	227	235	252	263	282	13	19	27	-	-
 <p>Sink base unit 2 deep drawers top deep drawer with central cutout for drain approx. 580 mm wide, approx. 325 mm deep</p>  <p>B → 600 mm → X = 300 mm B → 800 mm → X = 500 mm B → 900 mm → X = 600 mm B → 1000 mm → X = 700 mm B → 1200 mm → X = 900 mm</p>	CSP2A	60		211	221	228	237	258	273	295	10	16	32	-	-
	CSP2A	80		216	227	235	243	266	281	304	16	22	38	-	-
	CSP2A	90		229	239	246	255	275	290	311	16	22	38	-	-
	CSP2A	100		243	251	258	266	285	298	319	16	22	38	-	-
	CSP2A	120		274	279	285	293	308	319	338	16	22	38	-	-
 <p>Sink base unit 1 front panel 1 fixed inside panel</p> <p><i>For on-site installation of a waste collection system with deep drawer.</i></p>	CSP	45	T	74	76	77	79	83	84	88	-	-	-	-	-
	CSP	50	T	77	78	80	82	86	86	91	-	-	-	-	-
	CSP	60	T	81	83	85	86	91	92	97	-	-	-	-	-
 <p>Sink base unit 1 deep drawer 1 fixed inside panel</p>	CSPA	45		88	90	92	94	99	100	107	5	8	16	-	-
	CSPA	50		97	99	101	103	109	110	117	5	8	16	-	-
	CSPA	60		101	103	105	108	114	116	124	5	8	16	-	-
 <p>Sink base unit 1 deep drawer depth 400 mm 1 fixed inside panel</p> <p>NEW NEW NEW</p>	CSPA	45	K1	93	95	97	99	105	106	113	-	3	11	-	-
	CSPA	50	K1	102	104	106	108	115	116	123	-	3	11	-	-
	CSPA	60	K1	106	108	110	113	120	122	130	-	3	11	-	-

5.30 The anti-tilt device which is supplied automatically must be fitted for room divider versions.

Sink base units

787 mm high

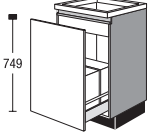
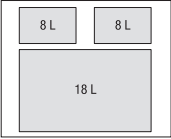
Unit without worktop and plinth, carcass depth 560 mm

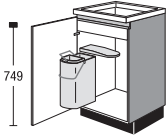
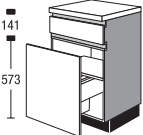
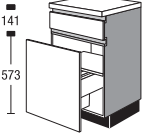
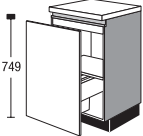
				Price group											
		width		1	2	3	4	5	6	7	Servosoft	Pro Servosoft	ProServoglass	Soft closing Top Motion	Soft closing Top Motion Plus
 <p>Sink base unit 1 deep drawer with waste bin for waste separation 1 fixed inside panel</p> <p>with 3 waste containers Capacity 1 x 18 litre container 2 x 8 litre containers 1 lid for 8 litre containers Organisation system</p> <p><i>Bottom edge carcass to top edge waste container approx. 350 mm</i></p>  <p>III. shows 60 cm width</p> 	CSPA	50	M	173	179	182	188	199	202	217	5	8	16	-	-
	CSPA	60	M	178	183	187	193	204	207	223	5	8	16	-	-
 <p>Sink base unit</p> <p>1 hinged door 1 fixed inside panel 1 waste bin 1 container 14 litres 1 container 5 litres</p> <p><i>Unit leaves factory ready fitting waste bin</i></p> <p>NEW NEW NEW</p>	CSP	45	MT1	117	123	128	132	138	146	158	-	-	-	4	4
	CSP	50	MT1	119	125	128	134	143	152	165	-	-	-	4	4
	CSP	60	MT1	121	128	136	143	161	165	174	-	-	-	4	4
 <p>Sink base unit</p> <p>1 fixed front panel 1 deep drawer</p> <p>1 cover panel 2 containers Capacity 2 containers 13 litres</p>	CSPBA	50	MH2	194	200	205	211	225	228	244	-	3	3	-	-
	CSPBA	60	MH2	199	206	211	218	230	234	250	-	3	3	-	-
 <p>Sink base unit</p> <p>1 fixed front panel 1 deep drawer</p> <p>1 cover panel 3 waste bins Capacity 2 containers 13 litres 1 container 17 litres</p>	CSPBA	60	MH3	210	216	221	229	243	246	263	-	3	3	-	-
 <p>Sink base unit</p> <p>1 deep drawer 1 fixed inside panel</p> <p>1 cover panel 2 containers Capacity 2 containers 13 litres</p>	CSPA	50	MH2	189	196	200	206	219	223	239	-	3	3	-	-
	CSPA	60	MH2	195	201	206	212	225	228	244	-	3	3	-	-

The anti-tilt device which is supplied automatically must be fitted for room divider versions.

Sink base units

787 mm high

Unit without worktop and plinth, carcass depth 560 mm

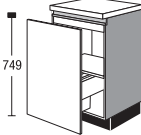
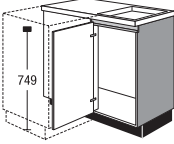
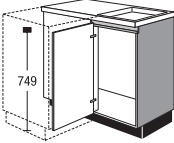
		width		Price group							Servosoft	Pro Servosoft	ProServoGlass	Soft closing Top Motion	Soft closing Top Motion Plus
				1	2	3	4	5	6	7					
 <p>Sink base unit 1 deep drawer 1 fixed inside panel 1 cover panel 3 waste bins Capacity 2 containers 13 litres 1 container 17 litres</p>	CSPA	60	MH3	205	211	216	224	237	241	258	-	3	3	-	-
 <p>Corner sink base unit with smooth built-in panel and loose infill panel 50 mm wide in door finish or door colour for adding on base units 1 hinged door <i>Planning dimensions: 1105-1300 x 616-650 mm</i> <i>Carcass width 1000 mm</i> <i>The corner infill panel is supplied with returns for kitchens planned with adjacent dishwasher.</i> <i>An additional infill panel must be ordered for planning dimensions over 650 mm.</i> <i>Installation of the waste bin ZAT 40 is not possible.</i></p> <p>Version L</p>	CSPE	115	with 50 cm door	134	142	149	155	165	178	195	-	-	-	4	4
<p>Corner sink base unit same as above, but <i>Planning dimensions: 1205-1400 x 616-650 mm</i> <i>Cannot be combined with drip insert EZIT...A.</i></p>	CSPE	125	with 60 cm door	136	146	153	162	179	188	203	-	-	-	4	4
 <p>Corner sink base unit with full-height back panel with smooth built-in panel and loose infill panel 50 mm wide in door finish or door colour for adding on base units 1 hinged door <i>Planning dimensions: 1005-1200 x 616-650 mm</i> <i>Carcass width 900 mm</i> <i>Installation of the waste bin ZAT 40 is not possible.</i> <i>The corner infill panel is supplied with returns for kitchens planned with adjacent dishwasher.</i> <i>An additional infill panel must be ordered for planning dimensions over 650 mm.</i> <i>Cannot be combined with drip insert EZIT...A.</i></p>	CSPE	105	RW with 40 cm door	140	148	154	160	170	182	198	-	-	-	4	4
<p>Corner sink base unit same as above, but <i>Planning dimensions: 1055-1250 x 616-650 mm</i> <i>Carcass width 900 mm</i></p>	CSPE	110	RW with 45 cm door	143	150	157	164	174	186	203	-	-	-	4	4

5.32 The anti-tilt device which is supplied automatically must be fitted for room divider versions.

Sink base units, Filler panels

787 mm high

Unit without worktop and plinth, carcass depth 560 mm

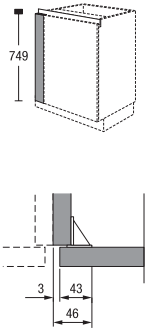
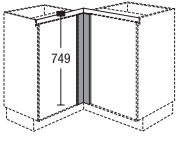
				Price group														
				width	1	2	3	4	5	6	7	Servosoft	Pro Servosoft	ProServoglass	Soft closing Top Motion	Soft closing Top Motion Plus		
<p>Corner sink base unit same as above, but <i>Planning dimensions: 1105-1300 x 616-650 mm</i> <i>Carcass width 1000 mm</i></p>				CSPE with 50 cm door	115	RW	144	151	158	164	175	187	204	-	-	-	4	4
<p>Corner sink base unit same as above, but <i>Planning dimensions: 1205-1400 x 616-650 mm</i> <i>Carcass width 1000 mm</i> <i>Cannot be combined with drip insert EZIT...A.</i></p>				CSPE with 60 cm door	125	RW	146	155	163	171	188	197	212	-	-	-	4	4
 <p>Infill panel for base units without plinth, 787 mm high Fitted between wall and carcass side <i>Finish in door material without edging on the wall side</i> <i>Not available in visible side colours.</i> <i>Due to the installation angle, the maximum possible on-site width reduction is 46 mm.</i></p>	CUPF	10		24	27	28	29	30	31	34	-	-	-	-	-	-		
	CUPF	20		28	31	32	33	35	37	40	-	-	-	-	-	-		
<p>Infill panel for base units same as above, but with carcass returns when planned next to a dishwasher.</p>	CUPF	10	GS	29	32	33	34	35	36	39	-	-	-	-	-			
	CUPF	20	GS	33	36	37	38	40	42	45	-	-	-	-	-			
 <p>Corner infill panel for base units without plinth, 787 mm high <i>Finish in door material for corner 650 x 650 mm</i> <i>Not available in visible side colours.</i></p>	CUPEF	65		29	32	33	34	35	37	41	-	-	-	-	-			
	CUPEF	65	GS	31	34	35	36	37	39	43	-	-	-	-	-			

The anti-tilt device which is supplied automatically must be fitted for room divider versions.

Filler panels

787 mm high

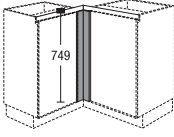
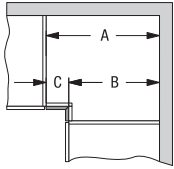
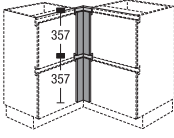
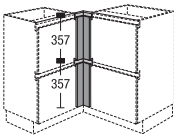
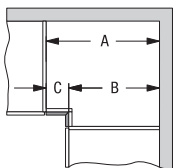
		width		Price group							Servosoft	Pro Servosoft	ProServoGlass	Soft closing Top Motion	Soft closing Top Motion Plus
				1	2	3	4	5	6	7					
 <p>Corner infill panel for base units without plinth, 787 mm high</p> <p><i>Finish in door material</i></p> <p><i>Dimensions given are from one carcass corner to another</i></p> <p><i>Side lengths less than 60 mm wide are not possible.</i></p>  <p><i>Not available in visible side colours.</i></p> <p>Panel size in mm: A=B=C</p>	CUPEF	66	V	33	37	38	39	40	43	47	-	-	-	-	-
	CUPEF	76	V	36	40	41	43	44	47	51	-	-	-	-	-
<p>Corner infill panel for base units same as above, but with carcass returns when planned next to a dishwasher.</p>	CUPEF	66	VGS	38	42	43	44	45	48	52	-	-	-	-	-
	CUPEF	76	VGS	41	45	46	48	49	52	56	-	-	-	-	-
 <p>Corner infill panel for base units with split front and handle profile without plinth, 787 mm high</p> <p><i>Finish in door material for corner 650 x 650 mm</i></p> <p><i>Not available in visible side colours.</i></p>	CUPEF	65	M2	61	67	69	72	74	78	86	-	-	-	-	-
	CUPEF	65	GSM2	65	71	73	75	78	82	90	-	-	-	-	-
 <p>Corner infill panel for base units with split front and handle profile without plinth, 787 mm high</p> <p><i>Finish in door material</i></p> <p><i>Dimensions given are from one carcass corner to another</i></p> <p><i>Side lengths less than 60 mm wide are not possible.</i></p>  <p><i>Not available in visible side colours.</i></p> <p>Panel size in mm: A=B=C</p>	CUPEF	66	VM2	67	75	77	79	81	87	95	-	-	-	-	-
	CUPEF	76	VM2	72	80	82	86	88	94	102	-	-	-	-	-
<p>Corner infill panel for base units with split front and handle profile same as above, but with carcass returns when planned next to a dishwasher.</p>	CUPEF	66	VGSM2	78	86	88	90	92	99	107	-	-	-	-	-
	CUPEF	76	VGSM2	83	91	93	97	99	105	113	-	-	-	-	-

5.34 The anti-tilt device which is supplied automatically must be fitted for room divider versions.

Filler panels

787 mm high

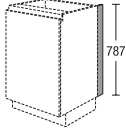
	width	Price group							Servosoft	Pro Servosoft	ProServoglass	Soft closing Top Motion	Soft closing Top Motion Plus
		1	2	3	4	5	6	7					
 <p>Infill panel base-unit side without plinth, 787 mm high 16 mm deep for wall end</p> <p><i>Finish laminate, stainless steel look</i></p> <p><i>for deeper tops, order plinth SO 151 separately</i></p>	CDTU	5	5	5	5	5	5	5	-	-	-	-	-

The anti-tilt device which is supplied automatically must be fitted for room divider versions.

5.35

LED recessed grip lighting



LED recessed grip lighting

7.8 W per metre started Profile
 Lighting of the handle recess (L profile) below the worktop for base units
 Colour temperature infinitely variable from warm white to cold white.
 Cover semi-transparent
 Light colour temperature:
 without control unit: 2700 K
 with control unit: 2700 - 6500 K
 Dimmer function: yes
 Beam angle: 120 degrees
 12 Volt
 incl. necessary end caps, inside/outside corners, fixings and connection cable
 Cable length 2.8 m incl. mini-plug
 Light source energy efficiency class: F

Order electronic LED transformers and connection accessories separately.

Not possible for units with handle profile milling.

Maximum length: 4000 mm

*Information on pricing:
 Depending on the planning software, the required length of the LED recessed grip ledge lighting must be specified in the commercial data for the correct price indication.*

Calculated per mm

7.8 W per metre started Profile

Inner corner 90° per piece

Outer corner 90° per piece

End cap left per piece

End cap right per piece

width

150
-4000

Item

CHLED U

CHLED IE

CHLED AE

CHLED EL

CHLED ER

universal

36

1

1

1

1

Wall units

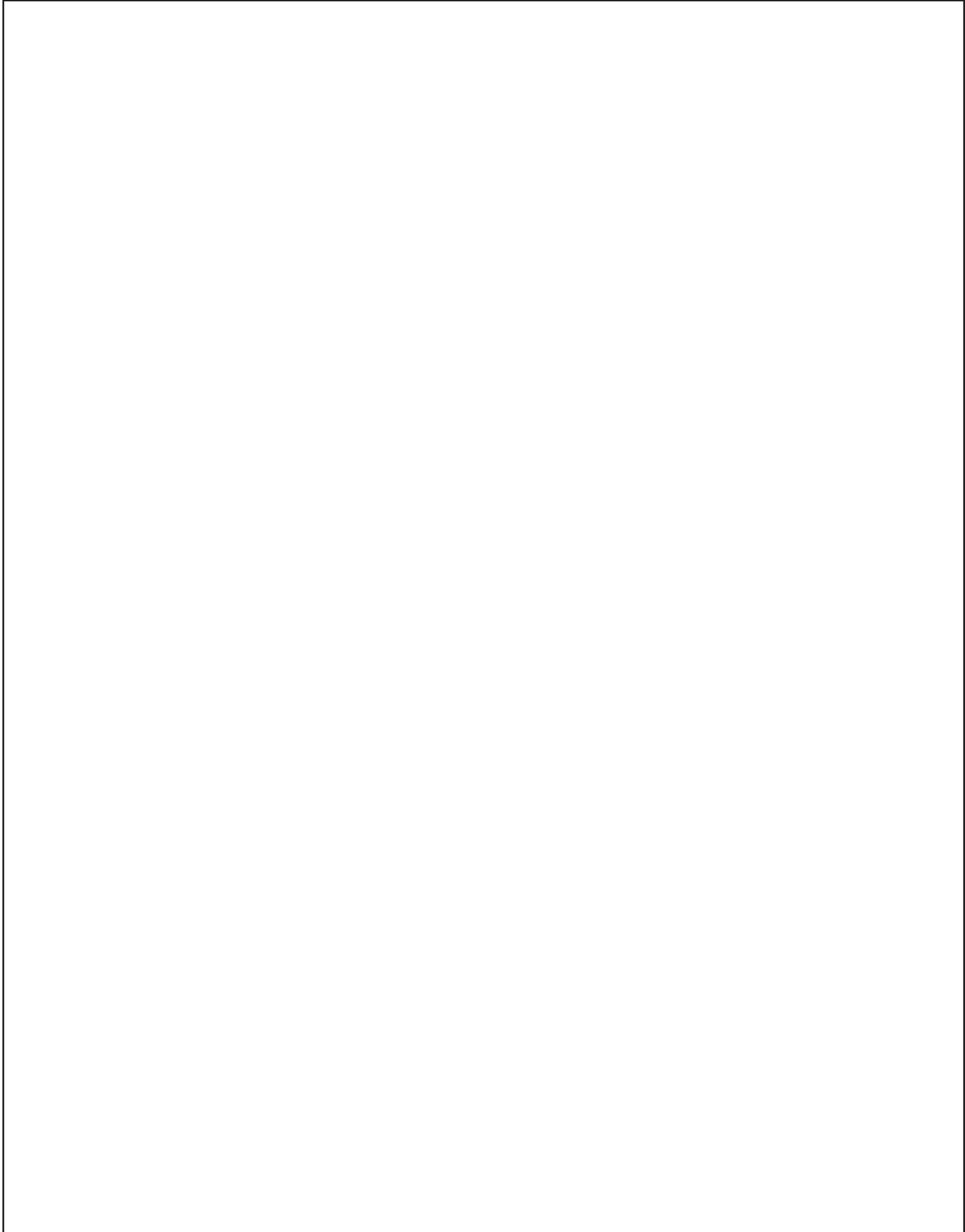

Wall units



Wall units



Summary of the most commonly planned wall units

CHK3029 CHK4029 CHK4529 CHK5029 CHK6029 CHK8029 CHK9029 CHK10029	CHK5036 CHK6036 CHK8036 CHK9036 CHK10036	CHKG5036 CHKG6036 CHKG8036 CHKG9036 CHKG10036	CH3001 CH4001 CH4501 CH5001 CH6001	CHFK4501 CHF5001 CHF6001 CHF8001 CHF9001 CHF10001	CHLK6001
CHE8001 CHE9001	CHG4501N1 CHG5001N1 CHG6001N1 CHG4501N1D CHG5001N1D CHG6001N1D	CHG4501 CHG5001 CHG6001	CHFKGU5001 CHFKGU6001 CHFKGU8001 CHFKGU9001 CHFKGU10001	CHD6001	CHD9001
CH3002 CH4002 CH4502 CH5002 CH6002	CHF5002 CHF6002 CHF8002 CHF9002 CHF10002	CHE8002 CHE9002	CHG4502N1 CHG5002N1 CHG6002N1 CHG4502N1D CHG5002N1D CHG6002N1D	CHG4502 CHG5002 CHG6002	CHF5002 CHF6002 CHF8002 CHF9002 CHF10002
CHD6002	CHD9002	CHM6002	CH3003 CH4003 CH4503 CH5003 CH6003	CHG4503N1 CHG5003N1 CHG6003N1 CHG4503N1D CHG5003N1D CHG6003N1D	CHG4503 CHG5003 CHG6003

Legend of symbols used

D

Interior finish

Unit interior in carcass finish
Not available in visible side colours.

Information on customised products

Please note the possible customisations for cabinets.
The following individualisations are possible:

- Width reduction
- Depth reduction
- Carcase with increased side depth

You will find further information on this under register 9 Design elements, special topics, sub-register Surcharges/
miscellaneous.

Equipment versions

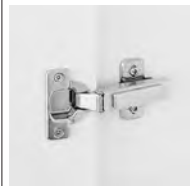

Clip hinge, standard version

Version 414

in combination with a high-quality flap stay



Cushioning for hinged doors Top Motion (surcharge)

Version 418

Integrated door cushioning CLIP top BLUMOTION by Blum
in combination with a high-quality flap stay



Cushioning for hinged doors Top Motion (surcharge)



Version 428

Integrated door cushioning CLIP top BLUMOTION by Blum
in combination with AVENTOS HKS flap stay by Blum



LED lighting options for wall units

Order electronic LED transformers, start sets and connection accessories separately.

		width	Item	universal	
<p>Planning advice</p> <p>Choosing the surcharge for the lighting option on the wall unit means the bottom shelf and/or the top shelf will have the required cut-out. The up/down lighting is fitted at the works, LED linear and LED built-in lights are added to the accessories box and have to be fitted on-site. This makes the order process easier as there is no need to order the lights in addition to the cut-out.</p> <p>The shelf features are chosen in the order header: 963 = features of bottom shelf 964 = features of top shelf</p> <p>Please observe the following planning information:</p> <ul style="list-style-type: none"> - Available for cabinet widths 300 - 1000 mm - Width and depth reductions are not possible - 60 cm and 65 cm corner wall units, diagonal wall units, shelf units in variable dimensions, end shelf units are not possible <p>Order electronic LED transformers, start sets and connection accessories separately.</p>					
	<p>Grip ledge with up/down LED lighting</p> <p>Version 200, surcharge per unit</p>		MP963	23	
		5.8 W, 490 lm			300
	Surcharge includes:	8.2 W, 673 lm			400
	Grip ledge with up/down LED lighting in bottom shelf of carcass instead of handle profile without lighting	9.3 W, 764 lm			450
	Light colour temperature:	10.5 W, 856 lm			500
	with control unit: 2700 - 6500 K, without control unit: 2700 K	12.8 W, 1039 lm			600
	including 1.8 metre extension cable as an accessory with mini-plug	17.5 W, 1405 lm			800
	Light source energy efficiency class	19.8 W, 1588 lm			900
	Top: F	22.1 W, 1771 lm			1000
	Bottom: G				
<p><i>Only possible for wall units with integrated handle profile on carcass base panel (article types CH...).</i></p> <p><i>Do not include light pelmets in plans.</i></p>					
	<p>LED built-in spotlight</p> <p>Extra charge per cabinet</p> <p>Version 221 = stainless steel effect</p>		MP963	8	
		1 light for units to 600 mm wide			
	Surcharge includes:	2 lights for units from 800 mm wide	MP963	15	
	cut-out in bottom shelf of cupboard				
	LED built-in spotlight, ZLI 58 ...				
	Each light: 4.0 W, 250 lm				
	Light colour temperature: 3000 K				
	with connecting cable, 2 metres, including mini-plug				
Light source energy efficiency class: F					
<p>LED built-in spotlight with colour control</p> <p>Extra charge per cabinet</p> <p>Version 220 = stainless steel effect</p> <p>Version 222 = black</p>					
Surcharge includes:	Version 220 = stainless steel effect	MP963	11		
cut-out in bottom shelf of cupboard	1 light for units to 600 mm wide				
with connecting cable, 2 metres, including mini-plug		MP963	21		
Energy efficiency of light source: refer to individual item					
	Version 220 = stainless steel effect				
Version 220 = stainless steel effect:					
LED built-in spotlight, ZLI 58 ECC					
Each light: 3.0 W, 160 lm					
Light colour temperature:	Version 222 = black	MP963	11		
with control unit: 3000 - 6000 K	1 light for units to 600 mm wide				
without control unit: 3000 K					
Version 222 = black:					
LED built-in spotlight, ZLI 58 SCC					
Each light: 4.0 W, 250 lm					
Light colour temperature:	Version 222 = black	MP963	21		
with control unit: 2700 - 6500 K	2 lights for units from 800 mm wide				
without control unit: 2700 K					



LED lighting options for wall units

Order electronic LED transformers, start sets and connection accessories separately.

		width	Item	universal
	<p>Cutout without light 58 mm in diameter <small>NEW</small></p> <p>Extra charge per cabinet</p> <p>Version 229</p> <p>Surcharge includes: cut-out in bottom shelf of cupboard 1 cut-out for units up to 600 mm width 2 cut-outs for units from 800 mm width</p>		MP963	7
	<p>Cutout without light 68 mm in diameter <small>NEW</small></p> <p>Extra charge per cabinet</p> <p>Version 449</p> <p>Surcharge includes: cut-out in bottom shelf of cupboard 1 cut-out for units up to 600 mm width 2 cut-outs for units from 800 mm width</p>		MP963	7
	<p>LED built-in light, straight aluminium profile</p> <p>Extra charge per cabinet</p> <p>Version 210 = stainless steel effect</p> <p>Surcharge includes: cut-out in bottom shelf of cupboard LED built-in light ZLIL...ECC Light colour temperature: with control unit: 2700 - 6500 K, without control unit: 2700 K with connecting cable, 2 metres, including mini-plug Light source energy efficiency class: G</p>	<p>3 W, 288 lm 300</p> <p>4.2 W, 396 lm 400</p> <p>4.8 W, 450 lm 450</p> <p>5.4 W, 504 lm 500</p> <p>6.6 W, 612 lm 600</p> <p>9 W, 828 lm 800</p> <p>10.2 W, 936 lm 900</p> <p>11.4 W, 1044 lm 1000</p>	MP963	18

LED lighting options for wall units





Order electronic LED transformers, start sets and connection accessories separately.

		width	Item	universal
 <p>LED built-in spotlight Extra charge per cabinet Version 221 = stainless steel effect</p> <p>Surcharge includes: Cut-out in top shelf of cupboard LED built-in spotlight, ZLI 58 ... Each light: 4.0 W, 250 lm Light colour temperature: 3000 K with connecting cable, 2 metres, including mini-plug Light source energy efficiency class: F</p> <p>LED built-in spotlight with colour control Extra charge per cabinet Version 220 = stainless steel effect Version 222 = black</p> <p>Surcharge includes: Cut-out in top shelf of cupboard with connecting cable, 2 metres, including mini-plug Energy efficiency of light source: refer to individual item</p> <p>Version 220 = stainless steel effect: LED built-in spotlight, ZLI 58 ECC Each light: 3.0 W, 160 lm Light colour temperature: with control unit: 3000 - 6000 K without control unit: 3000 K</p> <p>Version 222 = black: LED built-in spotlight: ZLI 58 SCC Each light: 4.0 W, 250 lm Light colour temperature: with control unit: 2700 - 6500 K without control unit: 2700 K</p>	1 light for units to 600 mm wide		MP964	8
	2 lights for units from 800 mm wide		MP964	15
	Version 220 = stainless steel effect 1 light for units to 600 mm wide		MP964	11
	Version 220 = stainless steel effect 2 lights for units from 800 mm wide		MP964	21
	Version 222 = black 1 light for units to 600 mm wide		MP964	11
	Version 222 = black 2 lights for units from 800 mm wide		MP964	21
<p>Cutout without light 58 mm in diameter Extra charge per cabinet Version 229</p> <p>Surcharge includes: Cut-out in top shelf of cupboard 1 cut-out for units up to 600 mm width 2 cut-outs for units from 800 mm width</p> <p>Cutout without light 68 mm in diameter Extra charge per cabinet Version 449</p> <p>Surcharge includes: Cut-out in top shelf of cupboard 1 cut-out for units up to 600 mm width 2 cut-outs for units from 800 mm width</p>		NEW	MP964	7
		NEW	MP964	7
 <p>LED built-in light, straight aluminium profile Extra charge per cabinet Version 210 = stainless steel effect</p> <p>Surcharge includes: Cut-out in top shelf of cupboard LED built-in light ZLIL...ECC Light colour temperature: with control unit: 2700 - 6500 K, without control unit: 2700 K with connecting cable, 2 metres, including mini-plug Light source energy efficiency class: G</p>	3 W, 288 lm	300	MP964	18
	4.2 W, 396 lm	400		
	4.8 W, 450 lm	450		
	5.4 W, 504 lm	500		
	6.6 W, 612 lm	600		
	9 W, 828 lm	800		
	10.2 W, 936 lm	900		
11.4 W, 1044 lm	1000			

Wall or top-mounted units, Wall units

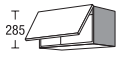
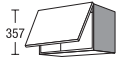
291 / 363 / 579 mm high

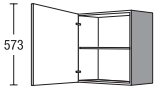
Carcase depth 326 mm

		width		Price group							Servosoft	Pro Servosoft	ProServoglass	Soft closing Top Motion	Soft closing Top Motion Plus	
				1	2	3	4	5	6	7						
 <p>Wall unit 1 flap door</p>	CHK	30	29	41	43	44	45	54	57	63	-	-	-	4	14	
	CHK	40	29	43	45	45	47	56	59	65	-	-	-	4	14	
	CHK	45	29	44	45	46	48	56	60	66	-	-	-	4	14	
	CHK	50	29	45	46	48	51	57	61	66	-	-	-	4	14	
	CHK	60	29	52	55	56	59	66	69	76	-	-	-	4	14	
	CHK	80	29	58	62	65	68	76	82	89	-	-	-	4	14	
	CHK	90	29	64	67	70	74	83	86	94	-	-	-	4	14	
	CHK	100	29	66	69	72	76	85	88	96	-	-	-	4	14	
 <p>Wall unit 1 flap door</p>	CHK	50	36	53	56	57	61	66	70	77	-	-	-	4	14	
	CHK	60	36	56	58	60	64	70	74	81	-	-	-	4	14	
	CHK	80	36	63	66	70	74	83	88	96	-	-	-	7	31	
	CHK	90	36	70	74	77	81	91	96	103	-	-	-	7	31	
	CHK	100	36	73	76	80	84	94	98	106	-	-	-	7	31	
 <p>Wall unit with glass flap door 1 glass flap door</p> <p><i>For glass and frame finishes please refer to programme summary</i></p> <p>Framed glass door No. 701</p>	CHKG	50	36	98	104	107	114	125	131	146	-	-	-	4	14	
	CHKG	60	36	102	107	110	117	129	136	150	-	-	-	4	14	
	CHKG	80	36	114	120	127	134	151	161	176	-	-	-	7	31	
	CHKG	90	36	119	126	132	138	156	163	176	-	-	-	7	31	
	CHKG	100	36	126	132	138	145	162	170	185	-	-	-	7	31	
 <p>Wall unit with glass flap door 1 glass flap door</p> <p><i>For glass and frame finishes please refer to programme summary</i></p>	CHKG	50	36	N1	128	134	137	144	155	161	176	-	-	-	4	14
	CHKG	60	36	N1	136	142	145	152	164	171	185	-	-	-	4	14
	CHKG	80	36	N1	150	157	164	170	187	197	212	-	-	-	7	31
	CHKG	90	36	N1	158	165	171	177	195	202	215	-	-	-	7	31
	CHKG	100	36	N1	168	175	181	187	205	213	227	-	-	-	7	31
 <p>Wall unit 1 hinged door 1 adjustable shelf</p>	CH	30	01	45	50	52	55	56	62	69	-	-	-	4	4	
	CH	40	01	50	54	56	58	62	66	73	-	-	-	4	4	
	CH	45	01	52	56	58	61	65	69	76	-	-	-	4	4	
	CH	50	01	54	57	60	63	66	72	79	-	-	-	4	4	
	CH	60	01	58	62	65	67	71	77	86	-	-	-	4	4	
 <p>Wall unit with upward folding door consisting of 2 fronts 1 adjustable shelf with pull-out safety device</p> <p><i>Folding door pivots approx. 140 mm upwards and 345 mm forwards from the upper front edge of the carcass. Upward lifting door takes up a minimum of space (depth) of 675 mm when open.</i></p> <p><i>Depending on the front weight, 1 or 2 energy-storage mechanisms are installed.</i></p>	CHFK	45	01	86	90	93	95	97	103	111	-	-	-	-	-	
	CHFK	50	01	91	96	98	101	104	109	118	-	-	-	-	-	
	CHFK	60	01	110	116	119	122	126	132	144	-	-	-	-	-	
	CHFK	80	01	118	126	130	135	145	156	172	-	-	-	-	-	
	CHFK	90	01	123	131	135	139	149	160	177	-	-	-	-	-	
	CHFK	100	01	126	135	138	143	153	164	180	-	-	-	-	-	

Wall units

579 mm high

Carcase depth 326 mm

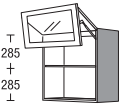
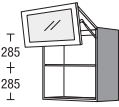
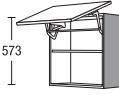

		width	Price group							Servosoft	Pro Servosoft	ProServoGlass	Soft closing Top Motion	Soft closing Top Motion Plus		
			1	2	3	4	5	6	7							
 <p>Wall unit with folding door with combined upward folding door consisting of 2 fronts top furniture door (in cabinet finish) framed glass door at bottom 2 adjustable glass shelves</p> <p>Framed glass door No. 711</p> <p><i>Folding door pivots approx. 140 mm upwards and 345 mm forwards from the upper front edge of the carcass.</i></p> <p><i>Upward lifting door takes up a minimum of space (depth) of 675 mm when open.</i></p> <p><i>For glass and frame finishes please refer to programme summary</i></p>	CHFKGU	50	01													
	CHFKGU	60	01													
	CHFKGU	80	01													
	CHFKGU	90	01													
	CHFKGU	100	01													
 <p>Wall unit with folding door with combined upward folding door consisting of 2 fronts top furniture door (in cabinet finish) framed glass door at bottom 2 adjustable glass shelves Carcass shelf with metal handle profile in stainless steel-effect</p> <p><i>Folding door pivots approx. 140 mm upwards and 345 mm forwards from the upper front edge of the carcass.</i></p> <p><i>Upward lifting door takes up a minimum of space (depth) of 675 mm when open.</i></p> <p><i>For glass and frame finishes please refer to programme summary</i></p>	CHFKGU	50	01	N1												
	CHFKGU	60	01	N1												
	CHFKGU	80	01	N1												
	CHFKGU	90	01	N1												
	CHFKGU	100	01	N1												
 <p>Wall unit with lift-up door 1 lift-up door with Softlift fitting 1 adjustable shelf with pull-out safety device</p> <p><i>The lift-up door pivots approx. 240 mm upwards and 445 mm forwards from the upper front edge of the carcass.</i></p>	CHLK	60	01													

5.44 Illustrations do not correspond to the door finishes.

Wall units

579 mm high

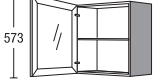
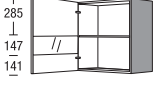
Carcase depth 326 mm

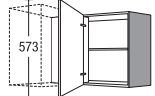





				Price group													
				width	1	2	3	4	5	6	7	Servosoft	Pro Servosoft	ProServoglass	Soft closing Top Motion	Soft closing Top Motion Plus	
 <p>573</p> <p>Framed glass door No. 701</p>	Wall unit with glass door				CHG	45	01										
	1 glass door			CHG	50	01											
	1 adjustable glass shelf			CHG	60	01											
<p><i>For available versions see overview Possible glass front versions</i></p> <p><i>For glass and frame finishes please refer to programme summary</i></p>																	
 <p>T 285</p> <p>147</p> <p>141</p> <p>Segmented glass door No. 706</p>	Wall unit with glass door			CHG	45	01	N1										
	1 glass door (range-independent)			CHG	50	01	N1										
	1 adjustable glass shelf			CHG	60	01	N1										
<p><i>Stainless steel look metal handle profile in the carcass base</i></p> <p>Type -N1</p> <p><i>For glass and frame finishes please refer to programme summary</i></p>				D													
 <p>573</p> <p>Framed glass door No. 704</p>	Wall unit with glass door			CHG	45	01	N1D										
	1 glass door (range-independent)			CHG	50	01	N1D										
	1 adjustable glass shelf			CHG	60	01	N1D										
<p><i>Stainless steel look metal handle profile in the carcass base</i></p> <p>Type -N1</p> <p><i>For glass and frame finishes please refer to programme summary</i></p>				D													
 <p>573</p> <p>Version L</p>	Corner wall unit			CHE	80	01											
	1 hinged door with Tip-On fitting			CHE	90	01											
	1 adjustable shelf																
<p><i>Without grip ledge</i></p> <p>CHE 80 01: Planning dimension 800 x 350 mm</p> <p>CHE 90 01: Planning dimension 900 x 400 mm suitable for CUE 90 (916 x 916 mm) in combination with CH 50 01</p>																	

Illustrations do not correspond to the door finishes.

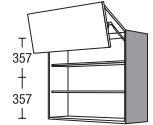
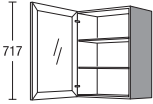
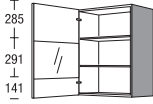
Wall units

723 mm high

Carcase depth 326 mm

			width	Price group							Servosoft	Pro Servosoft	ProServoGlass	Soft closing Top Motion	Soft closing Top Motion Plus	
				1	2	3	4	5	6	7						
 <p>Wall unit 1 hinged door 2 adjustable shelves</p>	CH	30	02	48	53	56	58	62	69	78	-	-	-	4	4	
	CH	40	02	54	57	60	63	67	74	82	-	-	-	4	4	
	CH	45	02	56	59	62	65	69	76	85	-	-	-	4	4	
	CH	50	02	57	61	64	67	73	80	89	-	-	-	4	4	
	CH	60	02	62	66	69	73	78	86	96	-	-	-	4	4	
 <p>Wall unit with upward folding door consisting of 2 fronts 2 adjustable shelves with pull-out safety device</p> <p><i>Folding door pivots approx. 205 mm upwards and 440 mm forwards from the upper front edge of the carcass. Upward lifting door takes up a minimum of space (depth) of 770 mm when open.</i></p>	CHFK	50	02	118	125	127	129	133	139	150	-	-	-	-	-	
	CHFK	60	02	124	130	133	136	139	146	157	-	-	-	-	-	
	CHFK	80	02	130	139	144	148	159	173	192	-	-	-	-	-	
	CHFK	90	02	138	148	153	157	169	184	204	-	-	-	-	-	
	CHFK	100	02	147	157	162	167	179	195	216	-	-	-	-	-	
 <p>Wall unit with glass door 1 glass door 2 adjustable glass shelves</p> <p><i>For available versions see overview Possible glass front versions</i></p> <p><i>For glass and frame finishes please refer to programme summary</i></p> <p>Framed glass door No. 701</p>	CHG	45	02	83	86	87	89	96	104	113	-	-	-	4	4	
	CHG	50	02	90	94	95	96	105	112	123	-	-	-	4	4	
	CHG	60	02	94	98	100	102	110	118	129	-	-	-	4	4	
 <p>Segmented glass door No. 706</p>																
 <p>Framed glass door No. 704</p>																
 <p>Wall unit with glass door 1 glass door (range-independent) 2 adjustable glass shelves</p> <p><i>Stainless steel look metal handle profile in the carcass base</i></p> <p>Type -N1</p> <p><i>For glass and frame finishes please refer to programme summary</i></p>	CHG	45	02	N1	122	122	122	122	122	122	-	-	-	4	4	
	CHG	50	02	N1	127	127	127	127	127	127	-	-	-	4	4	
	CHG	60	02	N1	141	141	141	141	141	141	141	-	-	-	4	4
	 CHG	45	02	N1D	144	144	144	144	144	144	144	-	-	-	4	4
	 CHG	50	02	N1D	149	149	149	149	149	149	149	-	-	-	4	4
	 CHG	60	02	N1D	164	164	164	164	164	164	164	-	-	-	4	4

5.46 Illustrations do not correspond to the door finishes.

Wall units

723 mm high

Carcase depth 326 mm

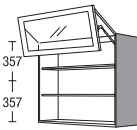
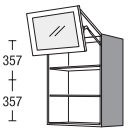
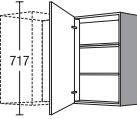

				Price group													
				width	1	2	3	4	5	6	7	Servosoft	Pro Servosoft	ProServoglass	Soft closing Top Motion	Soft closing Top Motion Plus	
 <p>Framed glass door No. 711</p>	Wall unit with folding door				CHFKGU	50	02										
	with combined upward folding door consisting of 2 fronts			CHFKGU	60	02											
	top furniture door (in cabinet finish)			CHFKGU	80	02											
	framed glass door at bottom			CHFKGU	90	02											
	2 adjustable glass shelves			CHFKGU	100	02											
<p><i>Folding door pivots approx. 205 mm upwards and 440 mm forwards from the upper front edge of the carcass.</i></p> <p><i>Upward lifting door takes up a minimum of space (depth) of 770 mm when open.</i></p> <p><i>For glass and frame finishes please refer to programme summary</i></p>																	
	Wall unit with folding door			CHFKGU	50	02	N1										
	with combined upward folding door consisting of 2 fronts			CHFKGU	60	02	N1										
	top furniture door (in cabinet finish)			CHFKGU	80	02	N1										
	framed glass door at bottom			CHFKGU	90	02	N1										
	2 adjustable glass shelves Carcass shelf with metal handle profile in stainless steel-effect			CHFKGU	100	02	N1										
<p><i>Folding door pivots approx. 205 mm upwards and 440 mm forwards from the upper front edge of the carcass.</i></p> <p><i>Upward lifting door takes up a minimum of space (depth) of 770 mm when open.</i></p> <p><i>For glass and frame finishes please refer to programme summary</i></p>																	
 <p>Version L</p>	Corner wall unit			CHE	80	02											
	1 hinged door with Tip-On fitting 2 adjustable shelves			CHE	90	02											
<p><i>Without grip ledge</i></p> <p><i>CHE 80 02: Planning dimension 800 x 350 mm</i></p> <p><i>CHE 90 02: Planning dimension 900 x 400 mm suitable for CUE 90 (916 x 916 mm) in combination with CH 50 02</i></p>																	

Illustrations do not correspond to the door finishes.

Wall units

867 mm high

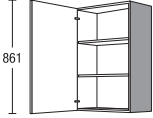
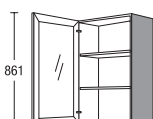
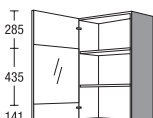



Carcase depth 326 mm

				Price group												
				width	1	2	3	4	5	6	7	Servosoft	Pro Servosoft	ProServoGlass	Soft closing Top Motion	Soft closing Top Motion Plus
 <p>Wall unit 1 hinged door 2 adjustable shelves <i>Stainless steel look metal handle profile in the carcass base</i></p>	CH	30	03	51	56	58	62	66	73	83	-	-	-	4	4	
	CH	40	03	56	60	63	66	71	77	86	-	-	-	4	4	
	CH	45	03	58	62	65	67	73	79	89	-	-	-	4	4	
	CH	50	03	60	64	66	71	76	84	94	-	-	-	4	4	
	CH	60	03	65	69	72	76	82	89	101	-	-	-	4	4	
 <p>Wall unit with glass door 1 glass door 2 adjustable glass shelves <i>Stainless steel look metal handle profile in the carcass base</i></p> <p><i>For available versions see overview Possible glass front versions</i></p> <p><i>For glass and frame finishes please refer to programme summary</i></p> <p>Framed glass door No. 701</p>	CHG	45	03	86	89	90	92	99	107	116	-	-	-	4	4	
	CHG	50	03	94	97	98	100	109	116	127	-	-	-	4	4	
	CHG	60	03	96	101	103	105	114	122	133	-	-	-	4	4	
 <p>Segmented glass door No. 706</p>  <p>Framed glass door No. 704</p>	CHG	45	03	N1	132	132	132	132	132	132	-	-	-	4	4	
	CHG	50	03	N1	138	138	138	138	138	138	138	-	-	-	4	4
 <p>Wall unit with glass door 1 glass door (range-independent) 2 adjustable glass shelves <i>Stainless steel look metal handle profile in the carcass base</i></p> <p>Type -N1</p> <p><i>For glass and frame finishes please refer to programme summary</i></p>	CHG	60	03	N1	153	153	153	153	153	153	-	-	-	4	4	
	<input type="checkbox"/> D	CHG	45	03	N1D	152	152	152	152	152	152	-	-	-	4	4
	<input type="checkbox"/> D	CHG	50	03	N1D	159	159	159	159	159	159	-	-	-	4	4
	<input type="checkbox"/> D	CHG	60	03	N1D	174	174	174	174	174	174	-	-	-	4	4
	<input type="checkbox"/> D	CHG	60	03	N1D	174	174	174	174	174	174	-	-	-	4	4

Wall units for appliances

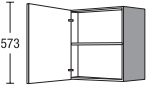
435 mm, 579 mm (01), 723 mm (02), 867 mm (03) high

Carcase depth 326 mm





		width		Price group							ServoSoft	Pro ServoSoft	ProServoGlass	Soft closing Top Motion	Soft closing Top Motion Plus		
				1	2	3	4	5	6	7							
<p>Information positioning frame for flat extractors</p> <p>Our wall units for telescopic extractors are not compatible with positioning frames for built-in appliances.</p>																	
	<p>Wall unit for telescopic cooker hood</p> <p>579 mm high 1 hinged door with Tip-On fitting 1 adjustable shelf</p> <p><i>Specify appliance type</i></p> <p><i>Rear panel set forward for appliance.</i></p> <p><i>Depending on appliance, an adjustment must be made on site.</i></p>	CHD	60	01	81	86	89	93	95	102	111	-	-	-	4	4	
	<p>Wall unit for telescopic cooker hood</p> <p>For appliances with a 900 mm wide housing/motor and a screen width of 900 mm 579 mm high 2 hinged doors with Tip-On fitting 1 adjustable shelf (depending on finish)</p> <p><i>Specify appliance type</i></p> <p><i>Rear panel set forward for appliance.</i></p> <p><i>Depending on appliance, an adjustment must be made on site.</i></p>	CHD	90	01	97	104	107	112	114	122	133	-	-	-	8	8	
	<p>Wall unit for telescopic cooker hood</p> <p>For appliances with a 600 mm wide housing/motor and a screen width of 900 mm 579 mm high 2 hinged doors with Tip-On fitting 2 shelf units in wall unit depth to left and right of extractor enclosure 1-2 adjustable shelves (according to version)</p> <p><i>Specify appliance type</i></p> <p><i>Rear panel set forward for appliance.</i></p> <p><i>Depending on appliance, an adjustment must be made on site.</i></p>	CHD	90	01	RS	205	210	215	219	230	242	251	-	-	-	8	8
	<p>Wall unit for microwaves</p> <p>723 mm high Aperture height: = 364, 380 mm</p> <p>1 flap door with Tip-On fitting</p> <p><i>Specify appliance type</i></p> <p><i>Niche sizes are adjusted with carcass panel</i></p> <p><i>One front panel per appliance type will be provided for adaptation on site.</i></p> <p><i>Not possible in combination with Top Motion Plus</i></p>	CHM	60	02	73	77	80	82	88	94	100	-	-	-	7	17	

Illustrations do not correspond to the door finishes.

Wall units for appliances

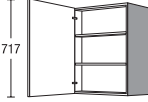
435 mm, 579 mm (01), 723 mm (02), 867 mm (03) high

Carcase depth 326 mm

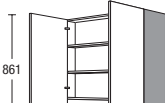
	width	Price group							Servosoft	Pro Servosoft	ProServoGlass	Soft closing Top Motion	Soft closing Top Motion Plus			
		1	2	3	4	5	6	7								
 <p>Wall unit for telescopic cooker hood</p> <p>723 mm high 1 hinged door with Tip-On fitting 2 adjustable shelves</p> <p><i>Specify appliance type</i></p> <p><i>Depending on appliance, an adjustment must be made on site.</i></p> <p><i>Rear panel set forward for appliance.</i></p>	CHD	60	02		89	96	99	104	107	116	126	-	-	-	4	4
 <p>Wall unit for telescopic cooker hood</p> <p>For appliances with a 900 mm wide housing/ motor and a screen width of 900 mm 723 mm high 2 hinged doors with Tip-On fitting 1 protruding back panel 1-2 adjustable shelves (according to version)</p> <p><i>Specify appliance type</i></p> <p><i>Rear panel set forward for appliance.</i></p> <p><i>Depending on appliance, an adjustment must be made on site.</i></p>	CHD	90	02		109	117	121	127	131	141	155	-	-	-	8	8
 <p>Wall unit for telescopic cooker hood</p> <p>For appliances with a 600 mm wide housing/ motor and a screen width of 900 mm 723 mm high 2 hinged doors with Tip-On fitting 2 shelf units in wall unit depth to left and right of extractor enclosure 1-2 adjustable shelves (according to version)</p> <p><i>Specify appliance type</i></p> <p><i>Rear panel set forward for appliance.</i></p> <p><i>Depending on appliance, an adjustment must be made on site.</i></p>	CHD	90	02	RS	219	225	231	237	250	265	277	-	-	-	8	8
 <p>Wall unit for telescopic cooker hood ^{NEW}</p> <p>867 mm high 1 hinged door with Tip-On fitting 2 adjustable shelves</p> <p><i>Specify appliance type</i></p> <p><i>Depending on appliance, an adjustment must be made on site.</i></p> <p><i>Rear panel set forward for appliance.</i></p>	CHD	60	03		98	106	111	116	122	133	146	-	-	-	4	4
 <p>Wall unit for telescopic cooker hood ^{NEW}</p> <p>For appliances with a 900 mm wide housing/ motor and a screen width of 900 mm 867 mm high 2 hinged doors with Tip-On fitting 1 protruding back panel 2 adjustable shelves</p> <p><i>Specify appliance type</i></p> <p><i>Rear panel set forward for appliance.</i></p> <p><i>Depending on appliance, an adjustment must be made on site.</i></p>	CHD	90	03		116	126	132	138	145	159	176	-	-	-	8	8

5.50 Illustrations do not correspond to the door finishes.

Wall units for appliances

435 mm, 579 mm (01), 723 mm (02), 867 mm (03) high

Carcase depth 326 mm

		width		Price group							Servosoft	Pro Servosoft	ProServoglass	Soft closing Top Motion	Soft closing Top Motion Plus
		60	43	1	2	3	4	5	6	7					
	<p>Wall unit for telescopic cooker hood</p> <p>CHD</p> <p>435 mm high 1 hinged door with Tip-On fitting 1 adjustable shelf</p> <p><i>Specify appliance type</i></p> <p><i>Not available in visible side colours.</i></p> <p><i>Rear panel set forward for appliance.</i></p> <p><i>Depending on appliance, an adjustment must be made on site.</i></p>	66	70	73	76	87	94	100	-	-	-	4	4		

Illustrations do not correspond to the door finishes.

Notes

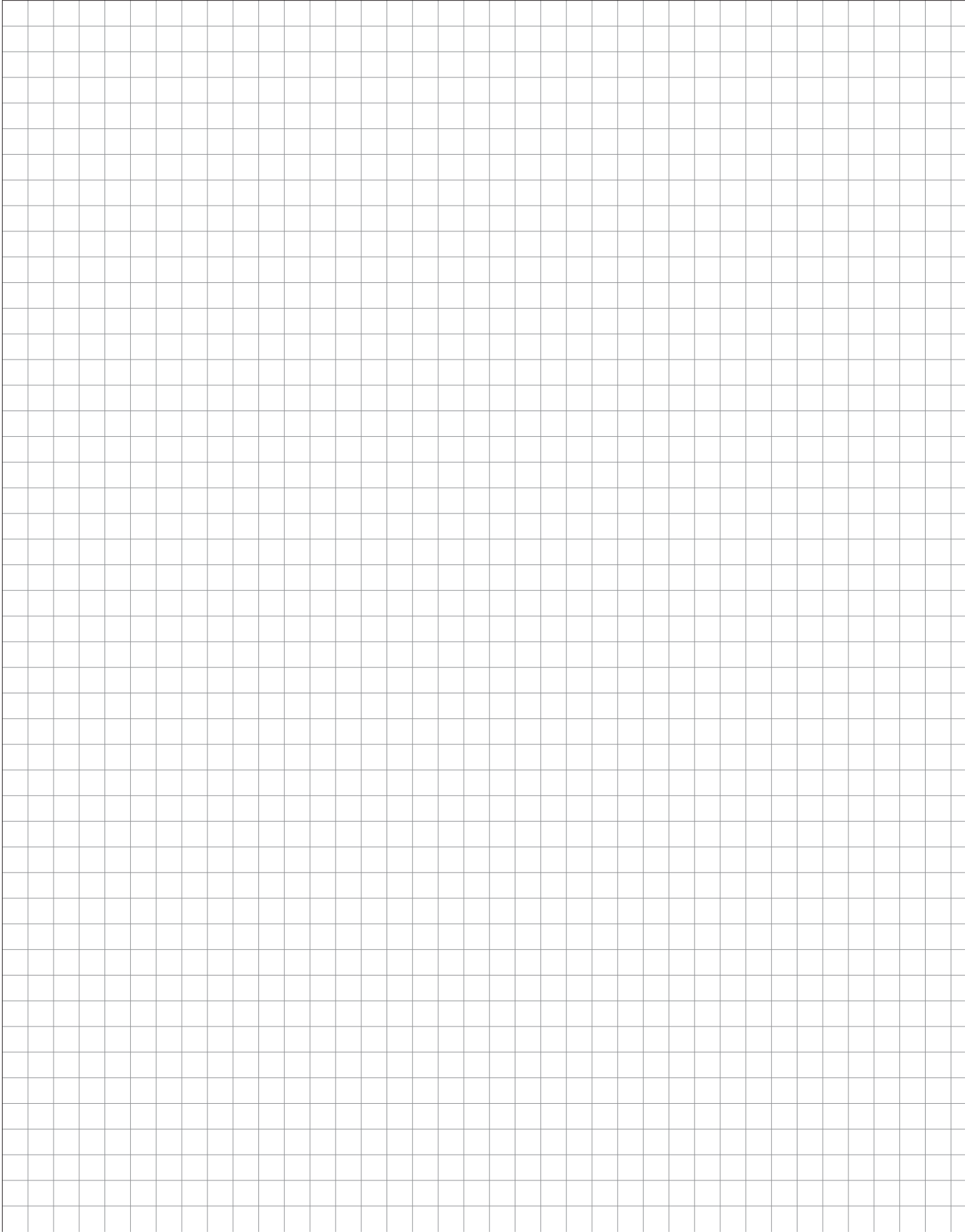

Information on tall units for integrated appliances

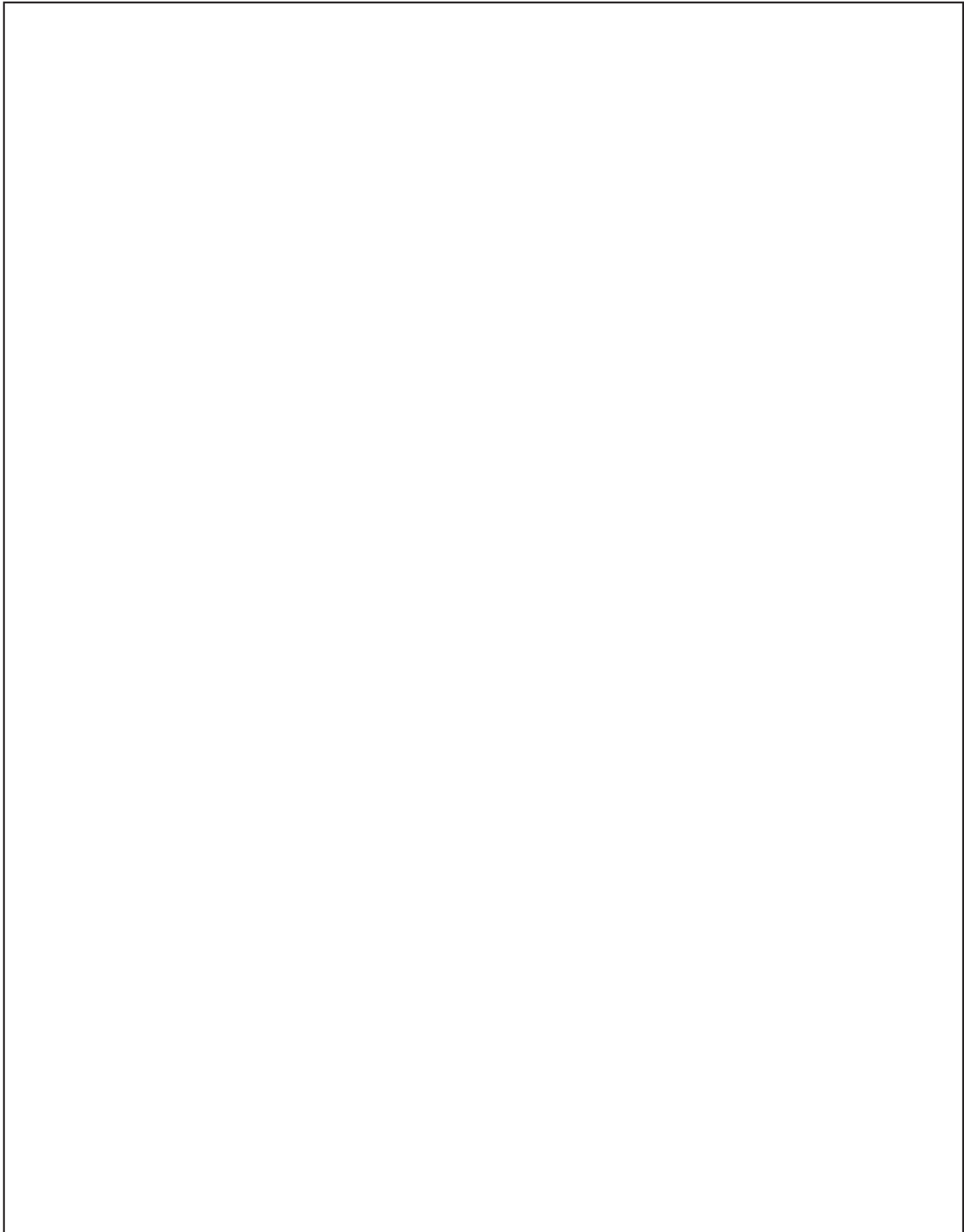

Information on tall units
for integrated appliances

Information on tall units
for integrated appliances

Information on highboards for integrated appliances

Sales/production types 1507 mm

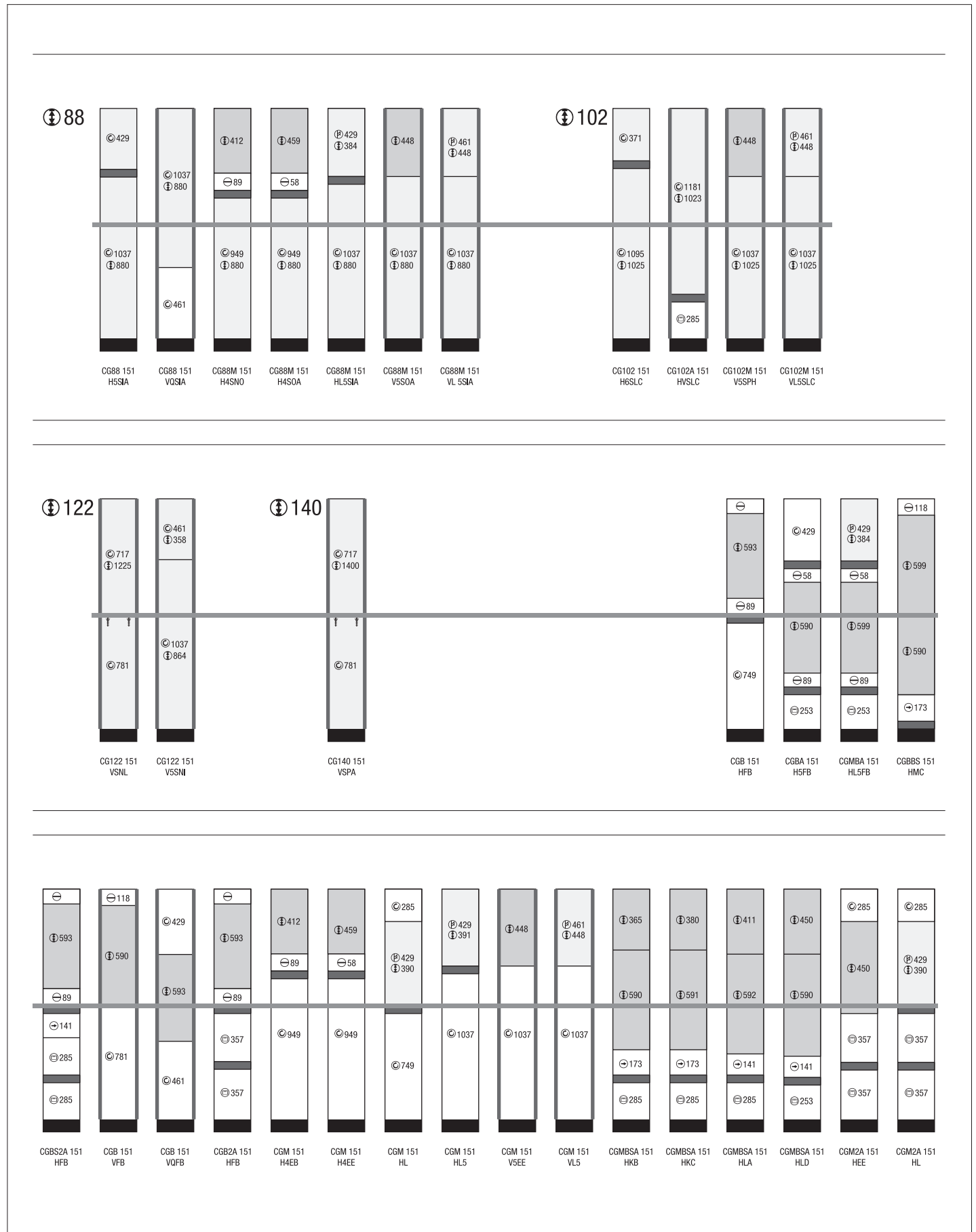

Information on tall units for integrated appliances

Sales/production types 1971 mm

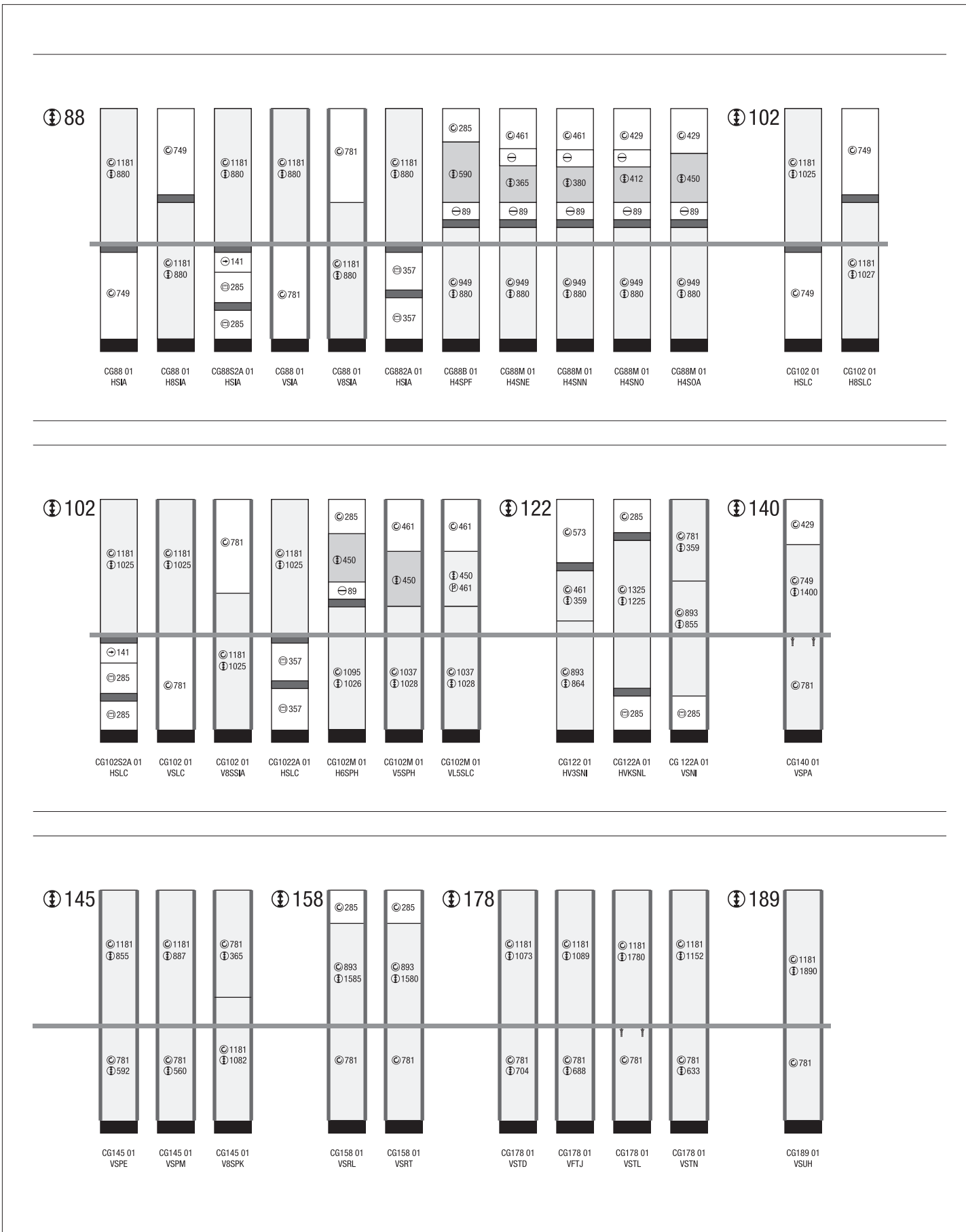

Information on tall units for integrated appliances

Sales/production types 1971 mm

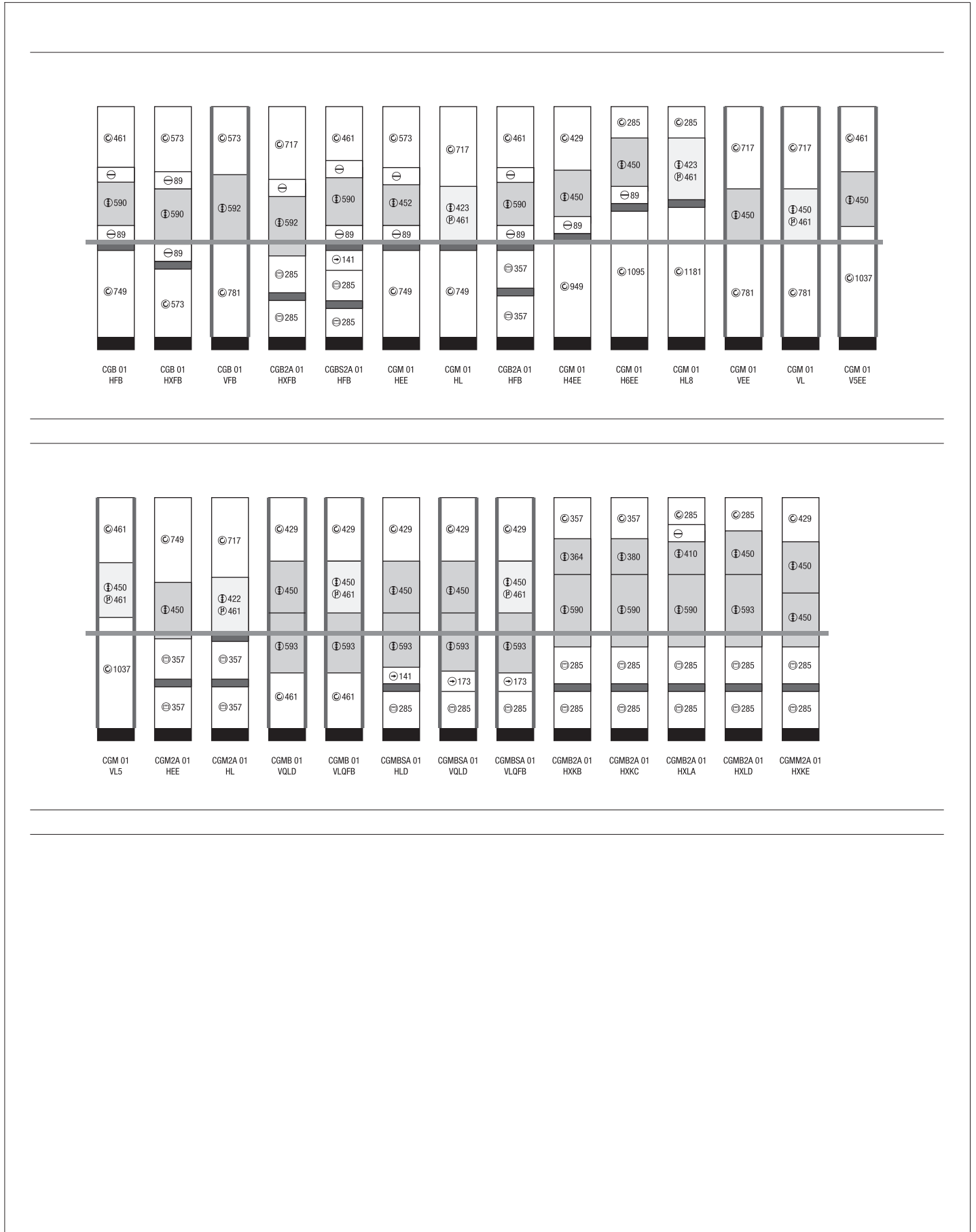

Information on tall units for integrated appliances

Sales/production types 2115 mm

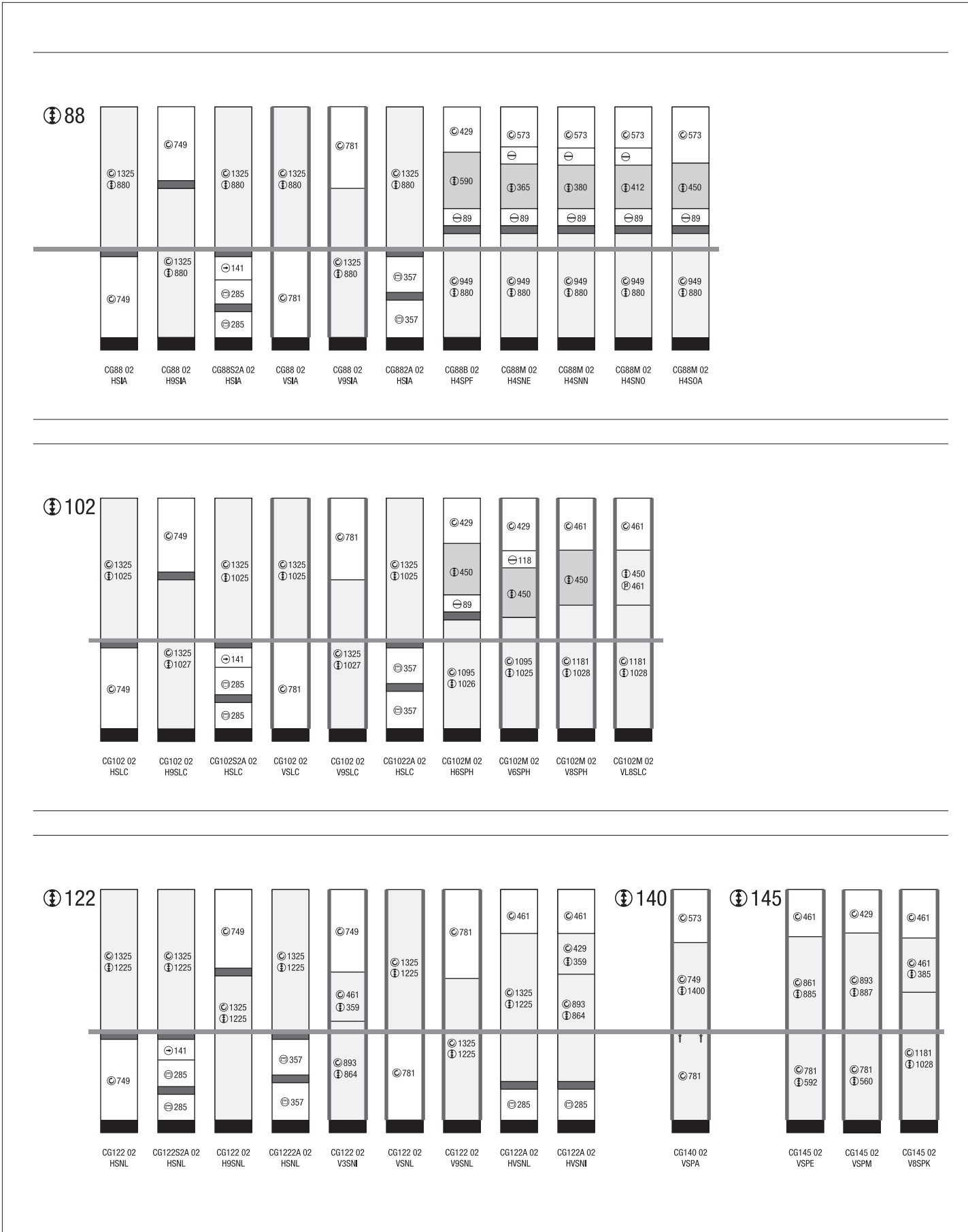

Information on tall units for integrated appliances

Sales/production types 2115 mm

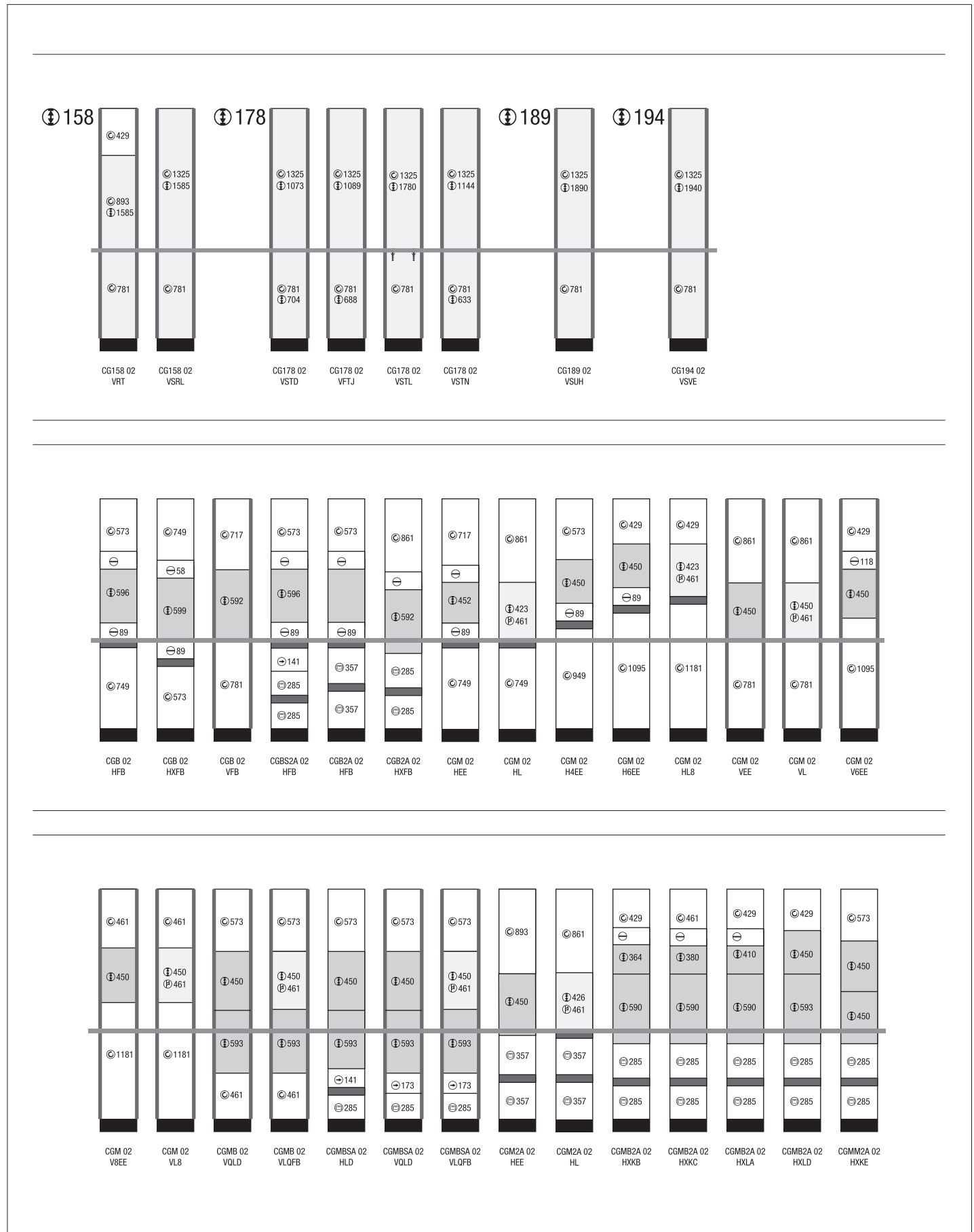

Information on highboards for integrated appliances

Sales/production types 2259 mm

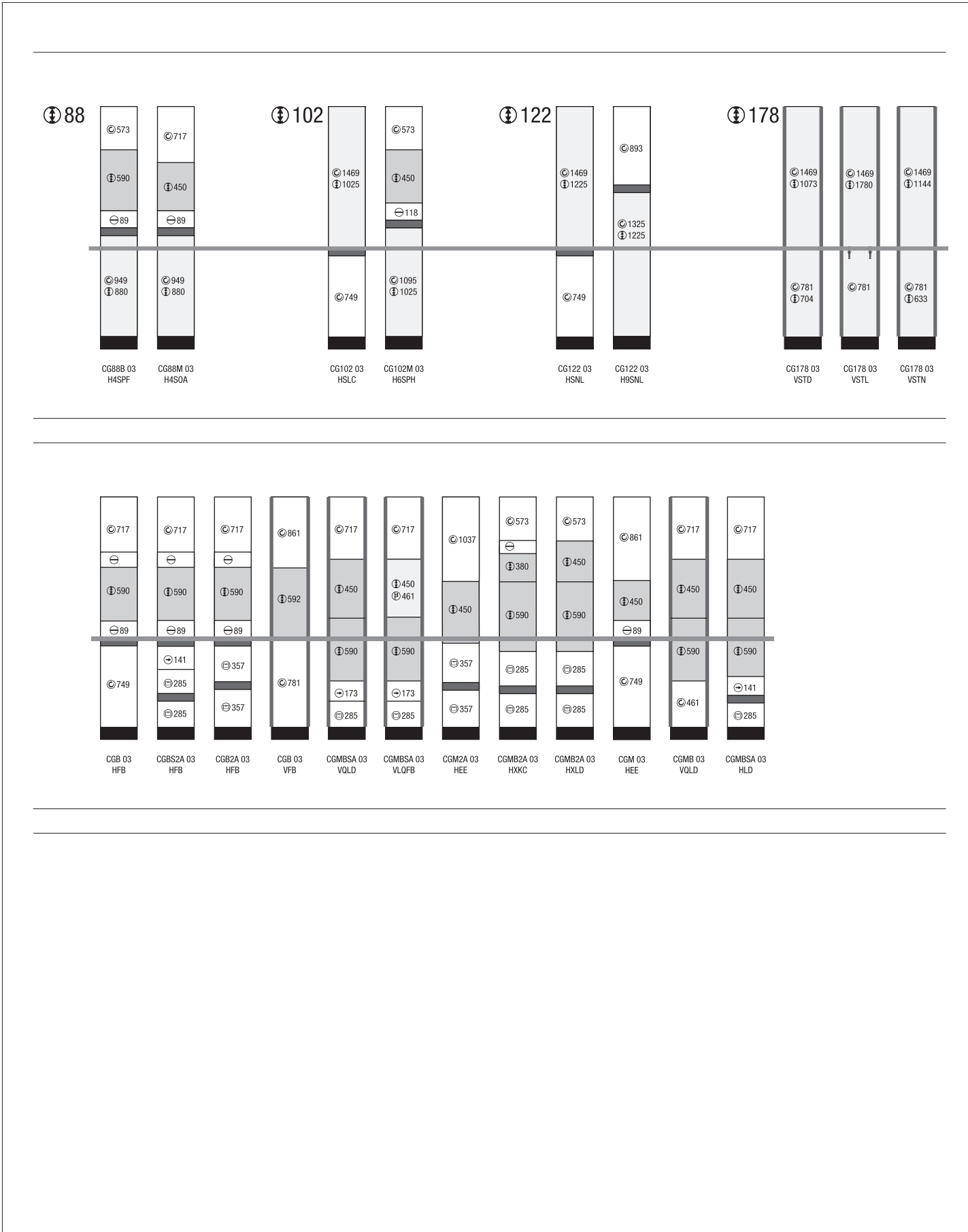

Highboards, tall units with horizontal recessed grip

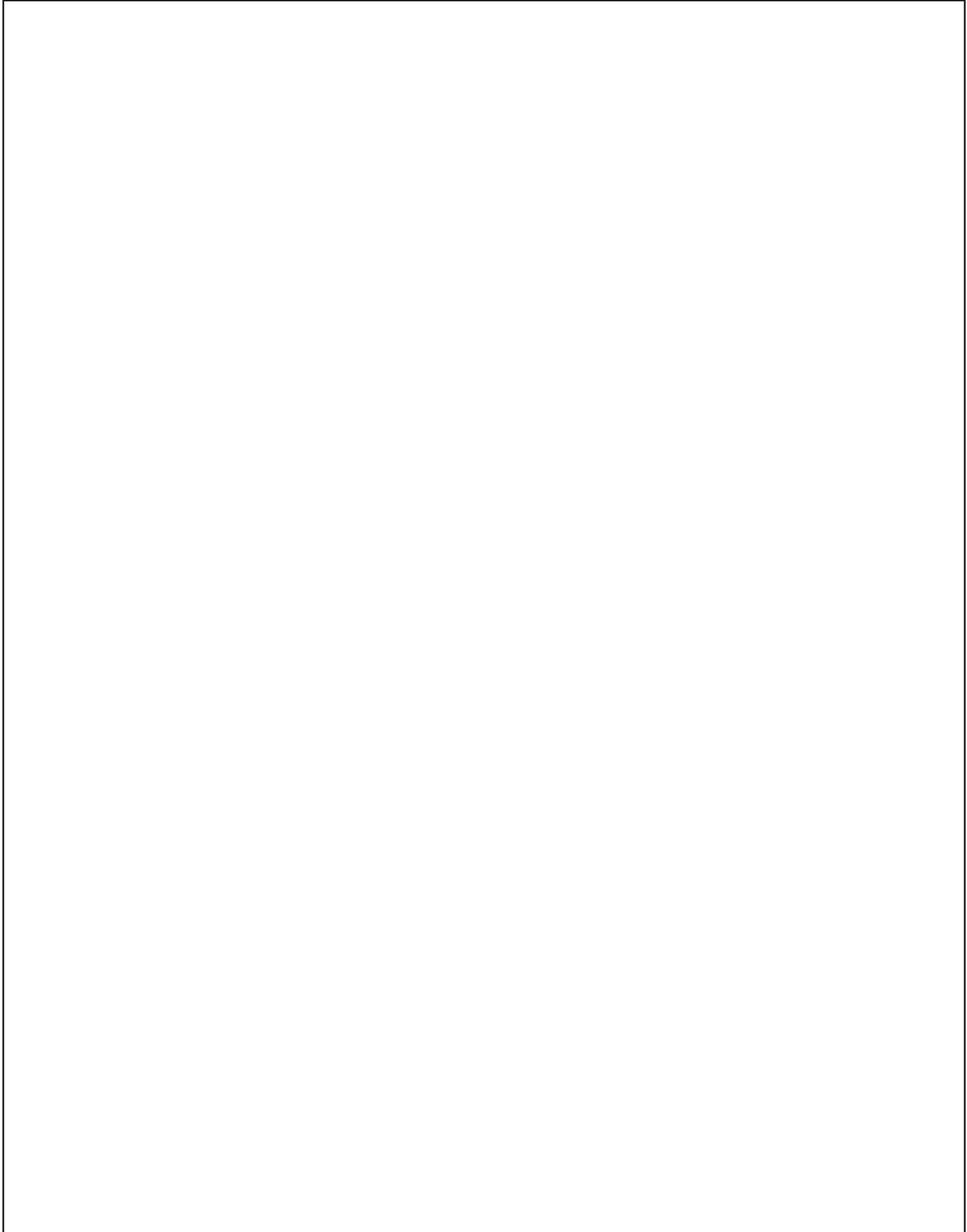

Highboards, tall units with
horizontal recessed grip

Highboards, tall units with
horizontal recessed grip

Summary of the most used/planned tall units

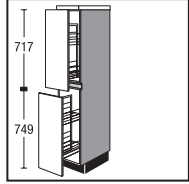

CSA30151HP

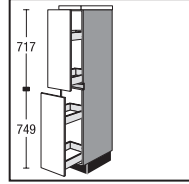

CSA30151HS

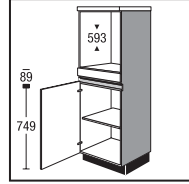

CGB151H

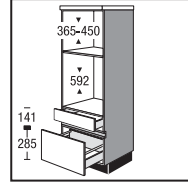

CGMBSA151H

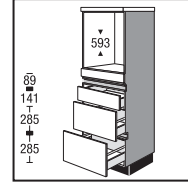

CGBS2A151H

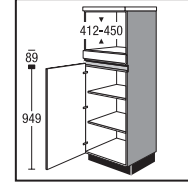

CGM151H4

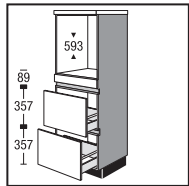

CGB2A151H

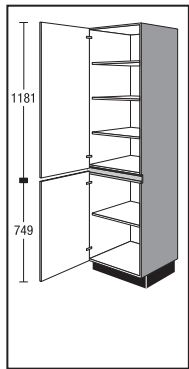

CS3001H
CS4501H
CS5001H
CS6001H

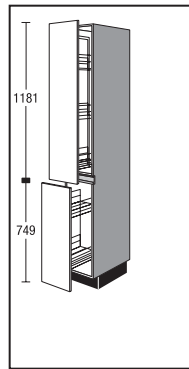

CSA3001H

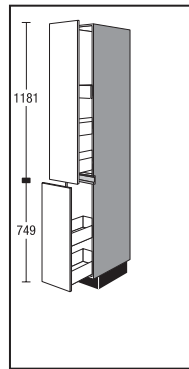

CSA3001HS

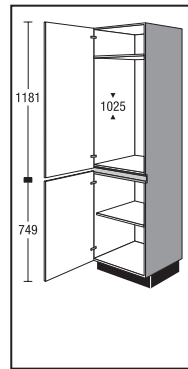

CG10201H

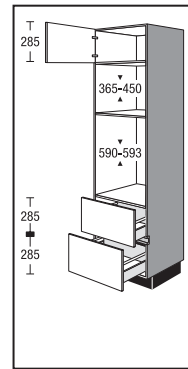

CGMB2A01HX

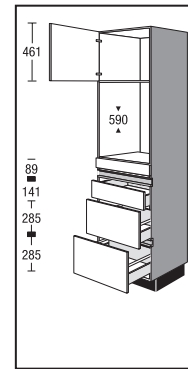

CGBS2A01H

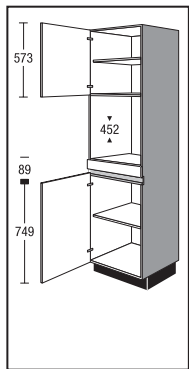

CGM01H

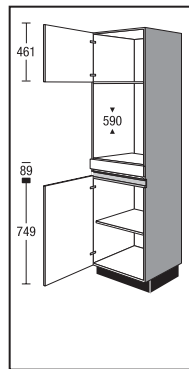

CGB01H

Summary of the most used/planned tall units

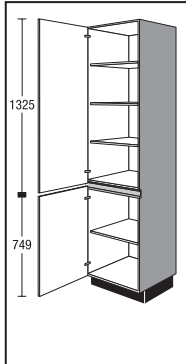

CS3002H
CS4502H
CS5002H
CS6002H

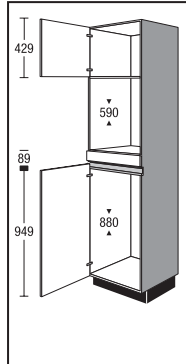

CG88B02H4

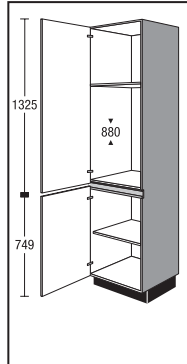

CG8802H

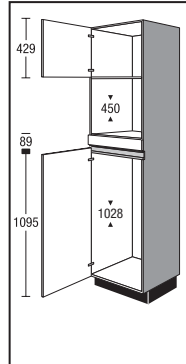

CG102M02H6

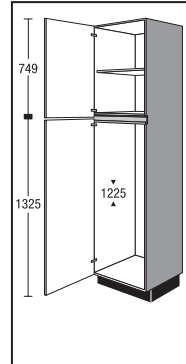

CG12202H9

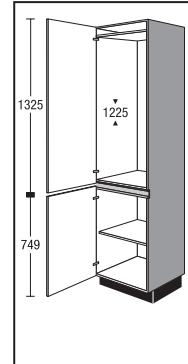

CG12202H

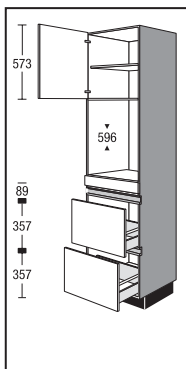

CGB2A02H

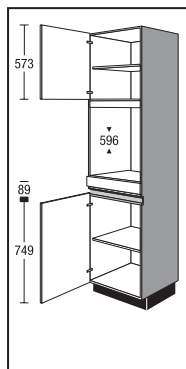

CGB02H

Legend of symbols used, Equipment versions



Depth reduction

Surcharge for depth reduction at the end of the subsection.

Units shortened to the next smallest unit width available.
Example: unit width 600 mm = shortened to 501 mm



Depth reduction

For surcharges and information see register 9 Design elements, special topics, sub-register Surcharges/miscellaneous



Width and depth reduction

Combination of both variants

For surcharges and information see register 9 Design elements, special topics, sub-register Surcharges/miscellaneous

Information on customised products

Please note the possible customisations for cabinets.

The following individualisations are possible:

- Width reduction
- Depth reduction
- Carcase with increased side depth

You will find further information on this under register 9 Design elements, special topics, sub-register Surcharges/miscellaneous.



Drawers / deep drawers in standard finish TANDEMBOX plus

Colour silver grey

Version:

506 = full-extension pull-out with Servosoft (allow for surcharge!)



Drawers / deep drawers Professional (surcharge) TANDEMBOX antaro

Colour anthracite

Full-extension pull-out with Servosoft

Version:

508 = Professional full-extension pull-out with Servosoft



Drawers / deep drawers Professional with glass side (surcharge) TANDEMBOX antaro

Colour anthracite

Full-extension pull-out with Servosoft

Versions:

510 = Professional with Servosoft and clear glass

512 = Professional with Servosoft and frosted glass

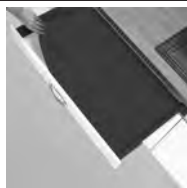

Non-slip mats

(surcharge per unit)

All drawers / deep drawers in a batch are fitted with the available non-slip mats

Drawer / deep drawer features:





Versions:

99 = Without non-slip mat

106 = Non-slip mat in silver-grey

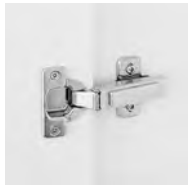
108 = Non-slip mat in anthracite

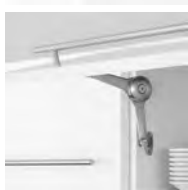
Equipment versions

	<p>Clip hinge, standard version Version 414 in combination with a high-quality flap stay</p>
	
	<p>Cushioning for hinged doors Top Motion (surcharge) Version 418 Integrated door cushioning CLIP top BLUMOTION by Blum in combination with a high-quality flap stay</p>
	
	<p>Cushioning for hinged doors Top Motion (surcharge) Version 428 Integrated door cushioning CLIP top BLUMOTION by Blum in combination with AVENTOS HKS flap stay by Blum</p>
	

Highboards

1507 mm high

Unit without worktop and plinth, carcass depth 560 mm. Order worktop separately.

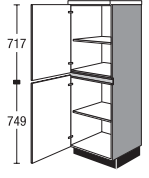
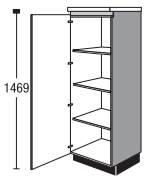
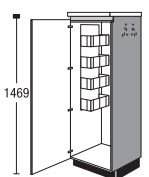
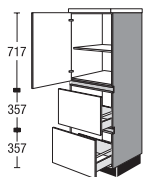
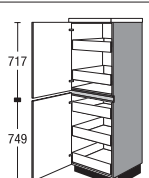
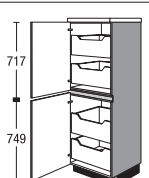
				width	Price group							Servosoft	Pro Servosoft	ProServoglass	Soft closing Top Motion	Soft closing Top Motion Plus	
					1	2	3	4	5	6	7						
 <p>Highboard 1 hinged door 1 adjustable shelf 1 hinged door 1 adjustable shelf</p>	<input checked="" type="checkbox"/>	CS	30	151	H	129	134	142	150	157	169	185	-	-	-	8	8
	<input checked="" type="checkbox"/>	CS	45	151	H	143	150	158	166	175	188	206	-	-	-	8	8
	<input checked="" type="checkbox"/>	CS	50	151	H	149	158	167	176	195	213	238	-	-	-	8	8
	<input checked="" type="checkbox"/>	CS	60	151	H	153	162	171	180	200	219	244	-	-	-	8	8
 <p>Highboard 1 hinged door 3 adjustable shelves</p>	NEW <input checked="" type="checkbox"/>	CS	30	151	HE	127	132	140	148	155	167	183	-	-	-	8	8
	NEW <input checked="" type="checkbox"/>	CS	45	151	HE	141	148	156	164	173	186	204	-	-	-	8	8
	NEW <input checked="" type="checkbox"/>	CS	50	151	HE	147	156	165	174	193	211	236	-	-	-	8	8
	NEW <input checked="" type="checkbox"/>	CS	60	151	HE	151	160	169	178	198	217	242	-	-	-	8	8
 <p>Highboard for brooms 1 hinged door 1 wire shelf 1 hook for brooms 1 universal holder for cable, hose and vacuum cleaner accessories stowage of vacuum cleaner, step ladder or ironing board possible <i>No wire parts if depth is reduced to less than 410 mm.</i></p>	NEW <input checked="" type="checkbox"/>	CS	45	151	HEB	140	147	155	163	172	185	203	-	-	-	8	8
	NEW <input checked="" type="checkbox"/>	CS	50	151	HEB	146	155	164	173	192	210	234	-	-	-	8	8
	NEW <input checked="" type="checkbox"/>	CS	60	151	HEB	150	159	168	177	197	216	240	-	-	-	8	8
 <p>Highboard 1 hinged door 1 adjustable shelf 2 deep drawers <i>Width can be shortened down to 300 mm</i></p>	<input checked="" type="checkbox"/>	CS2A	50	151	H	188	197	205	214	232	250	275	10	16	32	4	4
	<input checked="" type="checkbox"/>	CS2A	60	151	H	203	212	221	230	250	269	296	10	16	32	4	4
 <p>Highboard 1 hinged door 2 internal drawers 1 hinged door 3 interior drawers <i>The hinged doors must open to an angle of at least 90°. Door must not be hinged on side adjacent to the worktop.</i></p>	<input checked="" type="checkbox"/>	CS	30	151	HIS	221	230	241	251	273	294	322	25	40	40	8	8
	<input checked="" type="checkbox"/>	CS	45	151	HIS	248	258	269	279	303	325	357	25	40	40	8	8
	<input checked="" type="checkbox"/>	CS	50	151	HIS	261	273	283	295	320	343	376	25	40	40	8	8
	<input checked="" type="checkbox"/>	CS	60	151	HIS	267	278	290	301	326	350	385	25	40	40	8	8
 <p>Highboard 1 hinged door 2 interior deep drawers 1 hinged door 2 interior deep drawers <i>The hinged doors must open to an angle of at least 90°. Door must not be hinged on side adjacent to the worktop.</i></p>	<input checked="" type="checkbox"/>	CS	30	151	HIA	216	226	240	253	266	287	315	20	32	64	8	8
	<input checked="" type="checkbox"/>	CS	45	151	HIA	243	259	274	288	321	351	393	20	32	64	8	8
	<input checked="" type="checkbox"/>	CS	50	151	HIA	257	275	290	305	340	372	417	20	32	64	8	8
	<input checked="" type="checkbox"/>	CS	60	151	HIA	261	278	294	310	345	378	422	20	32	64	8	8







Illustrations do not correspond to front finishes / Door buffer = flap door stay buffer

5.63

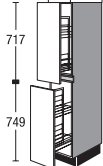
Highboards

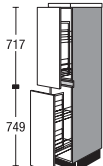
1507 mm high

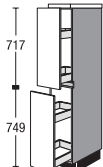

Unit without worktop and plinth, carcass depth 560 mm. Order worktop separately.

				width	Price group							Servosoft	Pro Servosoft	ProServoGlass	Soft closing Top Motion	Soft closing Top Motion Plus	
					1	2	3	4	5	6	7						
 <p>Pull-out larder highboard with cushioning 2 full-extension pull-outs with cushioning 4 adjustable baskets <i>Equipment feature baskets: wire parts silver grey</i></p>  <p>Baskets: clip-on baskets silver grey</p> <p>Suitable additions:</p> <p>Hanging basket silver-grey</p> <p>Insert tray plastic white 12 mm high</p>	CSA	30	151	H	327	343	346	349	356	370	394	-	-	-	-	-	
		ZIK	30			6	6	6	6	6	6	6	-	-	-	-	-
		ZIE	30			3	3	3	3	3	3	3	-	-	-	-	-
 <p>Pull-out larder highboard with cushioning 2 full-extension pull-outs with cushioning 4 adjustable baskets <i>Runner profile top and bottom Baskets can be used from both sides.</i></p>  <p>Baskets: wooden shelf and metal rail</p> <p><i>Basket features: Comfortline, wooden base with metal railing</i></p> <p><i>Supplementary unit information: Including full pull-out with cushioning</i></p> <p>Suitable additions:</p> <p>Hanging basket Wooden shelf with metal rail</p>	CSA	30	151	HP	351	367	370	373	380	394	419	-	-	-	-	-	
		ZIK	30	P		7	7	7	7	7	7	7	-	-	-	-	-
 <p>Highboard </p> <p>top: 1 deep drawer with 2 drawers</p> <p>bottom: 1 deep drawer with 2 drawers</p>	CSA	30	151	HS	174	184	186	189	194	203	217	20	32	32	-	-	

Highboards

1507 mm high

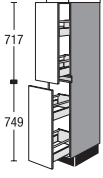
Unit without worktop and plinth, carcass depth 560 mm. Order worktop separately.

								Price group											
						width		1	2	3	4	5	6	7	Servosoft	Pro Servosoft	ProServoglass	Soft closing Top Motion	Soft closing Top Motion Plus
	Highboard		CSA	30	151	HA	186	197	199	202	207	217	232	20	32	64	-	-	
	top: 1 Auszug mit 2 Auszügen bottom: 1 Auszug mit 2 Auszügen																		

Illustrations do not correspond to front finishes / Door buffer = flap door stay buffer

5.65

Appliance housings with niche height 880 mm, Appliance housings with niche height 1025 mm

1507 mm high

Unit without worktop and plinth, carcass depth 560 mm. Order worktop separately.

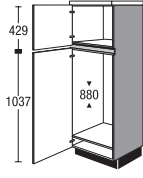
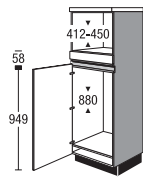
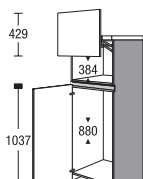
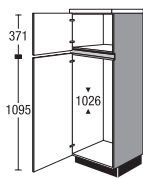
		width	Price group							Servosoft	Pro Servosoft	ProServoGlass	Soft closing Top Motion	Soft closing Top Motion Plus
			1	2	3	4	5	6	7					
 <p>Highboard for built-in appliances Niche height 880 mm 1 hinged door 1 appliance door <i>Ventilation grills for unit ventilation are included in the delivery.</i></p> <p>CG88 151 H5SIA</p>	CG88	151 H5	165	174	180	188	204	224	246	-	-	-	10	10
 <p>Highboard for built-in appliances Recess height 412 - 450 mm Niche height 880 mm 1 fixed front panel 1 appliance door <i>Niche size may be adjusted with internal infill panel or intermediate shelf</i> <i>Ventilation grills for unit ventilation are included in the delivery.</i></p> <p>CG88M 151 H4SOA</p>	CG88M	151 H4	188	196	203	211	228	246	271	-	-	-	6	6
 <p>Highboard for built-in appliances with lift-up door Recess height 384 mm Niche height 880 mm same as above, but plus 1 lift-up door Maximum size of stand-alone Height: 340 mm Width: 510 mm Depth: 540 mm 430 mm opening height for lift-up door <i>To be able to open the lift-up door, the top panel must not overhang by more than 28 mm.</i></p> <p>CG88M 151 HL5SIA</p>	CG88M	151 HL5	255	266	275	287	310	333	368	-	-	-	6	6
 <p>Highboard for built-in appliances Recess height 1026 mm 1 hinged door 1 appliance door <i>Niche size may be adjusted with internal infill panel or intermediate shelf</i> <i>Ventilation grills for unit ventilation are included in the delivery.</i></p> <p>CG102 151 H6SLC</p>	CG102	151 H6	172	181	189	197	217	235	257	-	-	-	10	10

Appliance housings with niche height 410 mm

1507 mm high

Unit without worktop and plinth, carcass depth 560 mm. Order worktop separately.

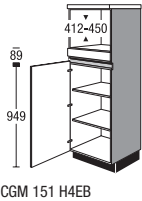
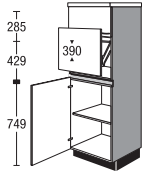
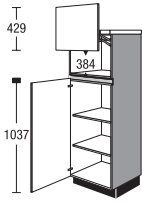
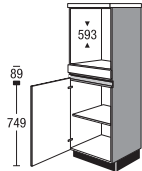
		width	Price group							Servosoft	Pro Servosoft	ProServoglass	Soft closing Top Motion	Soft closing Top Motion Plus		
			1	2	3	4	5	6	7							
 <p>CGM 151 H4EB</p>	<p>Highboard for built-in appliances Recess height 412 - 450 mm 1 fixed front panel 1 hinged door 2 adjustable shelves <i>Niche size may be adjusted with internal infill panel or intermediate shelf</i></p>	CGM	151	H4	194	202	208	217	234	252	277	-	-	-	6	6
 <p>CGM 151 HL</p>	<p>Highboard for built-in appliances with lift-up door Recess height 390 mm same as above, but 1 hinged door 1 adjustable shelf plus 1 lift-up door Maximum size of stand-alone Height 340 mm Width 510 mm Depth: 540 mm 430 mm opening height for lift-up door <i>To be able to open the lift-up door, the top panel must not overhang by more than 28 mm.</i></p>	CGM	151	HL	261	272	280	292	316	339	373	-	-	-	8	8
 <p>CGM 151 HL5</p>	<p>Highboard for built-in appliances with lift-up door Recess height 384 mm same as above, but no fixed front panel plus 1 lift-up door Maximum size of stand-alone Height 340 mm Width 510 mm Depth: 540 mm 430 mm opening height for lift-up door <i>To be able to open the lift-up door, the top panel must not overhang by more than 28 mm.</i></p>	CGM	151	HL5	261	272	280	292	316	339	373	-	-	-	6	6
 <p>CGB 151 HFB</p>	<p>Highboard for built-in appliances Niche height 593 mm 1 fixed front panel 1 hinged door 1 adjustable shelf <i>For foil-wrapped fronts a set of heat deflector plates are supplied free of charge.</i></p>	CGB	151	H	161	169	176	184	202	219	243	-	-	-	4	4

Illustrations do not correspond to front finishes / Door buffer = flap door stay buffer

5.67

Appliance housings with niche height 450 mm, Appliance housings with niche height 590 mm

1507 mm high

Unit without worktop and plinth, carcass depth 560 mm. Order worktop separately.

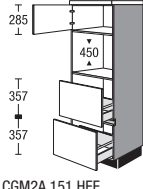
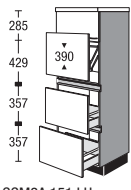
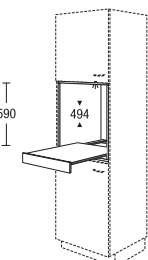
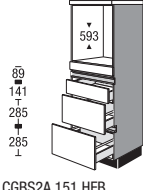
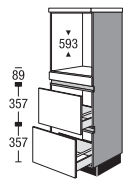
	CGM2A	width	Price group							Servosoft	Pro Servosoft	ProServoGlass	Soft closing Top Motion	Soft closing Top Motion Plus	
			1	2	3	4	5	6	7						
 <p>Highboard for built-in appliances Niche height 450 mm 1 hinged door with Tip-On fitting 2 deep drawers</p> <p>CGM2A 151 HEE</p>	CGM2A	151	H	194	196	197	202	211	214	227	10	16	32	4	4
 <p>Highboard for built-in appliances with lift-up door Recess height 390 mm same as above, but plus 1 lift-up door</p> <p>Maximum size of stand-alone Height 340 mm Width 510 mm Depth: 540 mm</p> <p>430 mm opening height for lift-up door</p> <p><i>To be able to open the lift-up door, the top panel must not overhang by more than 28 mm.</i></p> <p>CGM2A 151 LH</p>	CGM2A	151	HL	261	264	265	272	284	288	305	10	16	32	4	4
 <p>Modular built-in shelf unit for highboard / tall unit for niche heights 590 mm Depth: 505 mm 1 pull-out shelf</p> <p><i>Finish in carcass material</i> <i>Not available in visible side colours.</i></p> <p>MR</p>	MR	60	59	TA	201	201	201	201	201	201	201	-	-	-	-
 <p>Highboard for built-in appliances Niche height 593 mm 1 fixed front panel 1 drawer 2 deep drawers</p> <p><i>One front panel per appliance type will be provided for adaptation on site.</i> <i>For foil-wrapped fronts a set of heat deflector plates are supplied free of charge.</i></p> <p>CGBS2A 151 HFB</p>	CGBS2A	151	H	234	243	250	259	277	297	324	15	24	40	-	-
 <p>Highboard for built-in appliances Niche height 593 mm 1 fixed front panel 2 deep drawers</p> <p><i>One front panel per appliance type will be provided for adaptation on site.</i> <i>For foil-wrapped fronts a set of heat deflector plates are supplied free of charge.</i></p> <p>CGB2A 151 HFB</p>	CGB2A	151	H	217	225	231	240	257	275	300	10	16	32	-	-

Appliance housings with niche height 590 mm, Shelf units

1507 mm high

Unit without worktop and plinth, carcass depth 560 mm. Order worktop separately.

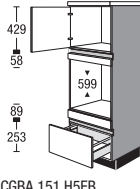
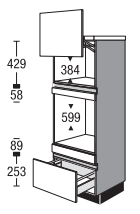
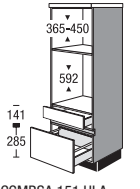
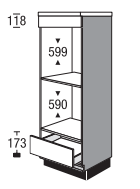
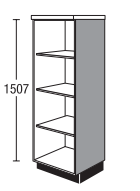
		width	Price group							Servosoft	Pro Servosoft	ProServoglass	Soft closing Top Motion	Soft closing Top Motion Plus	
			1	2	3	4	5	6	7						
 <p>Highboard for built-in appliances Recess height 599 mm</p> <p>1 hinged door 2 fixed front panels 1 deep drawer</p> <p><i>For foil-wrapped fronts a set of heat deflector plates are supplied free of charge.</i></p> <p>CGBA 151 H5FB</p>	CGBA	151	H5	218	228	238	250	274	299	331	5	8	16	4	4
 <p>Highboard for built-in appliances with lift-up door Recess height 384 mm Recess height 599 mm</p> <p>1 hinged door 2 fixed front panels same as above, but plus 1 lift-up door</p> <p>Maximum size of stand-alone Height 400 mm Width 510 mm Depth: 540</p> <p>430 mm opening height for lift-up door</p> <p><i>For foil-wrapped fronts a set of heat deflector plates are supplied free of charge.</i></p> <p><i>To be able to open the lift-up door, the top panel must not overhang by more than 28 mm.</i></p> <p>CGMBA</p>	CGMBA	151	HL5	285	299	311	326	358	391	433	5	8	16	-	-
 <p>Highboard for built-in appliances Recess height 365 - 450 mm Niche height 592 mm</p> <p>1 drawer 1 deep drawer</p> <p><i>Niche size may be adjusted with internal infill panel or intermediate shelf</i></p> <p><i>For foil-wrapped fronts a set of heat deflector plates are supplied free of charge.</i></p> <p>CGMBSA 151 HLA</p>	CGMBSA	151	H	167	177	184	193	212	233	261	10	16	24	-	-
 <p>Highboard for built-in appliances Recess height 599 mm niche height 590 mm</p> <p>1 fixed front panel 1 drawer</p> <p><i>For foil-wrapped fronts a set of heat deflector plates are supplied free of charge.</i></p> <p>CGBBS 151 HMC</p>	CGBBS	151	H	156	164	170	177	191	208	229	5	8	8	-	-
 <p>Highboard shelf unit</p> <p>3 adjustable shelves</p> <p><i>Finish in carcass material</i></p> <p><i>Please indicate desired width (150-600 mm).</i></p> <p><i>Not available in visible side colours.</i></p> <p>CSR</p>	CSR	V	151	203	203	203	203	203	203	203	-	-	-	-	-

Illustrations do not correspond to front finishes / Door buffer = flap door stay buffer

5.69

Fillers

1507 mm high

with neutral door division

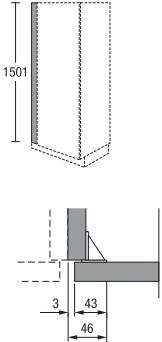
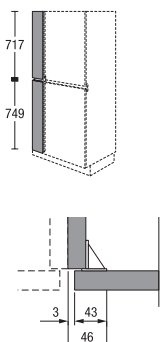
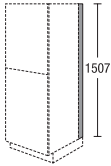
				width	Price group							Servosoft	Pro Servosoft	ProServoGlass	Soft closing Top Motion	Soft closing Top Motion Plus
					1	2	3	4	5	6	7					
 <p>Infill panel for highboard without plinth, 1507 mm high Fitted between wall and carcass side</p> <p><i>Finish in continuous door material without edging on the wall side</i></p> <p><i>Not available in visible side colours.</i></p> <p><i>Due to the installation angle, the maximum possible on-site width reduction is 46 mm.</i></p>	CSPF	10	151	E	28	32	33	34	36	39	43	-	-	-	-	-
	CSPF	20	151	E	35	38	40	42	49	54	60	-	-	-	-	-
 <p>Infill panel for highboard without plinth, 1507 mm high With horizontal handle profile Fitted between wall and carcass side</p> <p><i>Finish in door material without edging on the wall side</i></p> <p><i>Not available in visible side colours.</i></p> <p><i>The delivery is made in two parts.</i></p> <p><i>Due to the installation angle, the maximum possible on-site width reduction is 46 mm.</i></p>	CSPF	10	151	H	39	45	47	49	51	53	58	-	-	-	-	-
	CSPF	20	151	H	47	53	55	57	61	65	70	-	-	-	-	-
 <p>Infill panel for highboard side without plinth, 1507 mm high 16 mm deep for wall end</p> <p><i>Finish laminate, stainless steel look</i></p> <p><i>for deeper tops, order plinth SO 151 separately</i></p>	CDTS		151		10	10	10	10	10	10	10	-	-	-	-	-

Tall units

1971 mm high

Unit without plinth, carcass depth 560 mm

						Price group											
				width		1	2	3	4	5	6	7	Servosoft	Pro Servosoft	ProServoglass	Soft closing Top Motion	Soft closing Top Motion Plus
<p>Tall unit 1 hinged door 3 adjustable shelves 1 hinged door 1 adjustable shelf</p>	<input checked="" type="checkbox"/>	CS	30	01	H	125	134	142	150	169	185	207	-	-	-	10	10
	<input checked="" type="checkbox"/>	CS	45	01	H	156	165	173	181	201	218	241	-	-	-	10	10
	<input checked="" type="checkbox"/>	CS	50	01	H	163	172	180	189	207	225	249	-	-	-	10	10
	<input checked="" type="checkbox"/>	CS	60	01	H	173	181	190	199	217	234	259	-	-	-	10	10
<p>Tall unit 1 hinged door 1 adjustable shelf 1 hinged door 3 adjustable shelves</p>	<input checked="" type="checkbox"/>	CS	30	01	H8	125	134	142	150	169	185	207	-	-	-	10	10
	<input checked="" type="checkbox"/>	CS	45	01	H8	156	165	173	181	201	218	241	-	-	-	10	10
	<input checked="" type="checkbox"/>	CS	50	01	H8	163	172	180	189	207	225	249	-	-	-	10	10
	<input checked="" type="checkbox"/>	CS	60	01	H8	173	181	190	199	217	234	259	-	-	-	10	10
<p>Tall unit for crockery 1 hinged door 3 adjustable shelves 1 drawer 2 deep drawers</p>	<input checked="" type="checkbox"/>	CSS2A	30	01	H	188	195	203	209	225	239	261	15	24	40	6	6
	<input checked="" type="checkbox"/>	CSS2A	45	01	H	215	224	231	240	257	274	299	15	24	40	6	6
	<input checked="" type="checkbox"/>	CSS2A	50	01	H	224	232	241	250	267	284	311	15	24	40	6	6
	<input checked="" type="checkbox"/>	CSS2A	60	01	H	242	252	260	270	289	307	336	15	24	40	6	6
<p>Tall unit 1 hinged door 3 adjustable shelves 2 deep drawers</p> <p><i>Width can be shortened down to 300 mm</i></p>	<input checked="" type="checkbox"/>	CS2A	50	01	H	216	225	232	241	258	275	300	10	16	32	6	6
	<input checked="" type="checkbox"/>	CS2A	60	01	H	227	235	244	252	271	288	315	10	16	32	6	6

Illustrations do not correspond to front finishes / Door buffer = flap door stay buffer

5.71

Tall units

1971 mm high

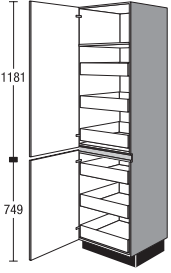
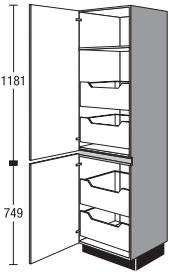

Unit without plinth, carcass depth 560 mm

				width	Price group												
					1	2	3	4	5	6	7	Servosoft	Pro Servosoft	ProServoGlass	Soft closing Top Motion	Soft closing Top Motion Plus	
 <p>Tall unit 1 hinged door 1 fixed shelf 3 interior drawers 1 hinged door 3 interior drawers</p> <p><i>The hinged doors must open to an angle of at least 90°. Door must not be hinged on side adjacent to the worktop.</i></p>	<input checked="" type="checkbox"/>	CS	30	01	HIS	257	276	289	303	327	348	378	30	48	48	10	10
	<input checked="" type="checkbox"/>	CS	45	01	HIS	289	308	324	339	366	389	421	30	48	48	10	10
	<input checked="" type="checkbox"/>	CS	50	01	HIS	297	317	332	348	376	401	434	30	48	48	10	10
	<input checked="" type="checkbox"/>	CS	60	01	HIS	315	335	352	370	398	424	458	30	48	48	10	10
 <p>Tall unit 1 hinged door 1 fixed shelf 2 interior deep drawers 1 hinged door 2 interior deep drawers</p> <p><i>The hinged doors must open to an angle of at least 90°. Door must not be hinged on side adjacent to the worktop.</i></p>	<input checked="" type="checkbox"/>	CS	30	01	HIA	229	246	259	273	305	334	372	20	32	64	10	10
	<input checked="" type="checkbox"/>	CS	45	01	HIA	262	278	291	305	338	367	406	20	32	64	10	10
	<input checked="" type="checkbox"/>	CS	50	01	HIA	274	288	302	317	347	375	416	20	32	64	10	10
	<input checked="" type="checkbox"/>	CS	60	01	HIA	283	298	312	325	356	384	424	20	32	64	10	10

Tall units

1971 mm high

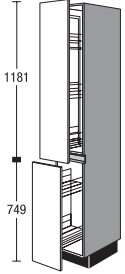
Unit without plinth, carcass depth 560 mm

				Price group												
				width	1	2	3	4	5	6	7	Servosoft	Pro Servosoft	ProServoGlass	Soft closing Top Motion	Soft closing Top Motion Plus
 <p>Pull-out tall unit with cushioning 1 full-extension pull-out with cushioning 3 adjustable baskets 1 full-extension pull-out with cushioning 2 adjustable baskets <i>Equipment feature baskets: wire parts silver grey</i></p>  <p>Baskets: clip-on baskets silver grey</p> <p>Suitable additions:</p> <p>Hanging basket silver-grey</p> <p>Insert tray plastic white 12 mm high</p>	CSA	30	01	H	397	412	413	415	429	432	452	-	-	-	-	-
	ZIK	30			6	6	6	6	6	6	6	-	-	-	-	-
	ZIE	30			3	3	3	3	3	3	3	-	-	-	-	-



Illustrations do not correspond to front finishes / Door buffer = flap door stay buffer

5.73

Tall units

1971 mm high

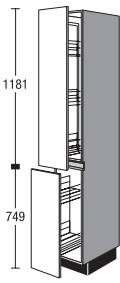
Unit without plinth, carcass depth 560 mm

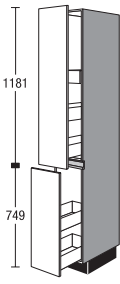
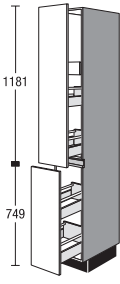
				width	Price group							Servosoft	Pro Servosoft	ProServoGlass	Soft closing Top Motion	Soft closing Top Motion Plus
					1	2	3	4	5	6	7					
 <p>Pull-out tall unit with cushioning 1 full-extension pull-out with cushioning 3 adjustable baskets 1 full-extension pull-out with cushioning 2 adjustable baskets</p> <p><i>Runner profile top and bottom Baskets can be used from both sides.</i></p> <p><i>Basket features: Comfortline, wooden base with metal railing</i></p> <p><i>Supplementary unit information: Including full pull-out with cushioning</i></p>	CSA	30	01	HP	449	464	465	467	481	484	506	-	-	-	-	-
	 <p>Baskets: wooden shelf and metal rail</p> <p>Suitable additions:</p> <p>Hanging basket Wooden shelf with metal rail</p>	ZIK	30		P	7	7	7	7	7	7	7	-	-	-	-
 <p>Tall unit 1 deep drawer with 2 drawers 1 internal drawer 1 deep drawer with 2 drawers</p>	<input checked="" type="checkbox"/> CSA	30	01	HS	207	222	224	228	233	244	261	25	40	40	-	-
 <p>Tall unit 1 Auszug mit 2 Auszügen 1 interior deep drawer 1 Auszug mit 2 Auszügen</p>	<input checked="" type="checkbox"/> <small>NEW</small> CSA	30	01	HA	219	235	237	241	247	258	276	25	40	72	-	-

Appliance housings with niche height 880 mm

1971 mm high

Unit without plinth, carcass depth 560 mm

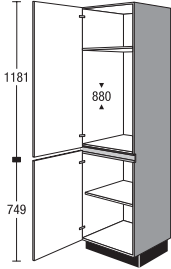
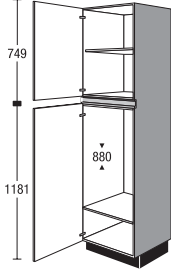
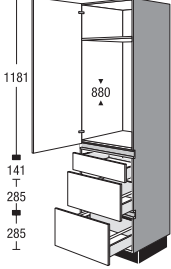
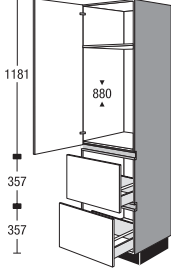
	width	Price group							Servosoft	Pro Servosoft	ProServoglass	Soft closing Top Motion	Soft closing Top Motion Plus		
		1	2	3	4	5	6	7							
 <p>Tall unit for appliances Niche height 880 mm</p> <ul style="list-style-type: none"> 1 hinged appliance door 1 fixed shelf 1 hinged door 1 adjustable shelf <p><i>For cladding up to the ceiling, provision must be made for a ventilation opening of min. 200 cm² in diameter.</i></p> <p>CG88 01 HSIA</p>	CG88	01	H	168	179	189	201	228	252	283	-	-	-	10	10
 <p>Tall unit for appliances Niche height 880 mm</p> <ul style="list-style-type: none"> 1 hinged door 1 adjustable shelf 1 hinged appliance door 1 fixed shelf <p><i>For cladding up to the ceiling, provision must be made for a ventilation opening of min. 200 cm² in diameter.</i></p> <p>CG88 01 H8SIA</p>	CG88	01	H8	168	179	189	201	228	252	283	-	-	-	10	10
 <p>Tall unit for appliances Niche height 880 mm</p> <ul style="list-style-type: none"> 1 hinged appliance door 1 fixed shelf 1 drawer 2 deep drawers <p><i>For cladding up to the ceiling, provision must be made for a ventilation opening of min. 200 cm² in diameter.</i></p> <p>CG88S2A 01 HSIA</p>	CG88S2A	01	H	237	252	265	277	300	325	360	15	24	40	6	6
 <p>Tall unit for appliances Niche height 880 mm</p> <ul style="list-style-type: none"> 1 hinged appliance door 1 fixed shelf 2 deep drawers <p><i>For cladding up to the ceiling, provision must be made for a ventilation opening of min. 200 cm² in diameter.</i></p> <p>CG882A 01 HSIA</p>	CG882A	01	H	220	234	246	257	277	301	334	10	16	32	8	8

Illustrations do not correspond to front finishes / Door buffer = flap door stay buffer

5.75

Appliance housings with niche height 880 mm, Appliance housings with niche height 1025 mm

1971 mm high

Unit without plinth, carcass depth 560 mm

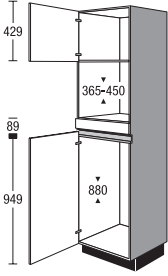
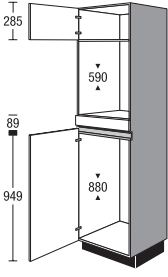
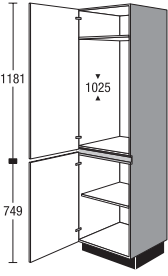
	width	Price group							Servosoft	Pro Servosoft	ProServoGlass	Soft closing Top Motion	Soft closing Top Motion Plus		
		1	2	3	4	5	6	7							
 <p>Tall unit for appliances Recess height 365 - 450 mm Niche height 880 mm</p> <p>1 hinged door with Tip-On fitting 1 fixed front panel 1 hinged appliance door</p> <p><i>One front panel per appliance type will be provided for adaptation on site.</i></p> <p><i>Recess sizes are adjusted in part through the use of carcass panels.</i></p> <p><i>Version supplied may deviate from the illustration according to appliance type.</i></p> <p><i>For cladding up to the ceiling, provision must be made for a ventilation opening of min. 200 cm² in diameter.</i></p> <p>CG88M01 H4SOA</p>	CG88M	01	H4	179	188	193	198	223	243	266	-	-	-	10	10
 <p>Tall unit for appliances niche height 590 mm Niche height 880 mm</p> <p>1 hinged door with Tip-On fitting 1 fixed front panel 1 hinged appliance door</p> <p><i>One front panel per appliance type will be provided for adaptation on site.</i></p> <p><i>Recess sizes are adjusted in part through the use of carcass panels.</i></p> <p><i>Version supplied may deviate from the illustration according to appliance type.</i></p> <p><i>For cladding up to the ceiling, provision must be made for a ventilation opening of min. 200 cm² in diameter.</i></p> <p><i>For foil-wrapped fronts a set of heat deflector plates are supplied free of charge.</i></p> <p>CG88B 01 H4SPF</p>	CG88B	01	H4	177	186	190	195	219	238	260	-	-	-	10	10
 <p>Tall unit for appliances niche height 1025 mm</p> <p>1 hinged appliance door 1 fixed shelf 1 hinged door 1 adjustable shelf</p> <p><i>For cladding up to the ceiling, provision must be made for a ventilation opening of min. 200 cm² in diameter.</i></p> <p>CG102 01 HSLC</p>	CG102	01	H	168	179	189	201	228	252	283	-	-	-	10	10

Appliance housings with niche height 1025 mm

1971 mm high

Unit without plinth, carcass depth 560 mm

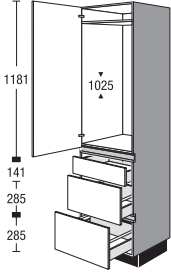
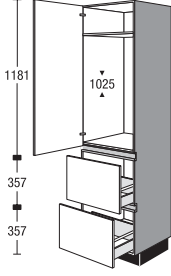
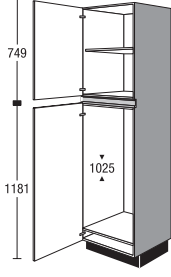
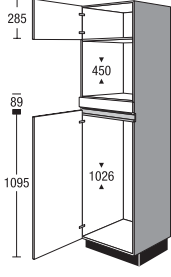
		width	Price group							Servosoft	Pro Servosoft	ProServoglass	Soft closing Top Motion	Soft closing Top Motion Plus	
			1	2	3	4	5	6	7						
 <p>Tall unit for appliances niche height 1025 mm</p> <ul style="list-style-type: none"> 1 hinged appliance door 1 fixed shelf 1 drawer 2 deep drawers <p><i>For cladding up to the ceiling, provision must be made for a ventilation opening of min. 200 cm² in diameter.</i></p> <p>CG102S2A 01 HSLC</p>	CG102S2A	01	H	240	255	268	281	303	329	365	15	24	40	6	6
 <p>Tall unit for appliances niche height 1025 mm</p> <ul style="list-style-type: none"> 1 hinged appliance door 1 fixed shelf 2 deep drawers <p><i>For cladding up to the ceiling, provision must be made for a ventilation opening of min. 200 cm² in diameter.</i></p> <p>CG1022A 01 HSLC</p>	CG1022A	01	H	220	234	246	257	277	301	334	10	16	32	6	6
 <p>Tall unit for appliances niche height 1025 mm</p> <ul style="list-style-type: none"> 1 hinged door 1 adjustable shelf 1 hinged appliance door <p><i>For cladding up to the ceiling, provision must be made for a ventilation opening of min. 200 cm² in diameter.</i></p> <p>CG102 01 H8SLC</p>	CG102	01	H8	168	179	189	201	228	252	283	-	-	-	10	10
 <p>Tall unit for appliances Niche height 450 mm Recess height 1026 mm</p> <ul style="list-style-type: none"> 1 hinged door with Tip-On fitting 1 fixed front panel 1 appliance door <p><i>One front panel per appliance type will be provided for adaptation on site.</i></p> <p><i>Version supplied may deviate from the illustration according to appliance type.</i></p> <p><i>For cladding up to the ceiling, provision must be made for a ventilation opening of min. 200 cm² in diameter.</i></p> <p>CG102M 01 H6SPH</p>	CG102M	01	H6	183	194	199	204	230	252	276	-	-	-	10	10

Illustrations do not correspond to front finishes / Door buffer = flap door stay buffer

5.77

Appliance housings with niche height 1225 mm, Appliance housings with niche height 450 mm

1971 mm high

Unit without plinth, carcass depth 560 mm

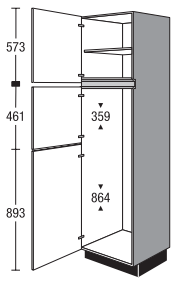
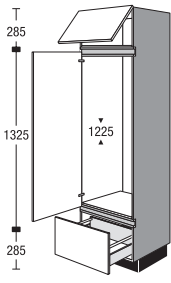
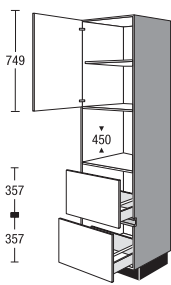
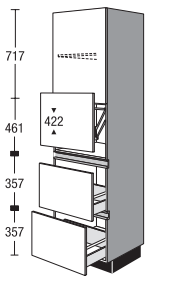
	width	Price group							Servosoft	Pro Servosoft	ProServoGlass	Soft closing Top Motion	Soft closing Top Motion Plus		
		1	2	3	4	5	6	7							
 <p>Tall unit for appliances Recess height 359 mm Recess height 864 mm 1 hinged door 1 adjustable shelf 2 hinged appliance doors <i>niche size adjustment partially with infill panels.</i> <i>Version supplied may deviate from the illustration according to appliance type.</i> For cladding up to the ceiling, provision must be made for a ventilation opening of min. 200 cm² in diameter.</p> <p>CG122 01 HV3SNI</p>	CG122	01	HV3	179	190	204	219	234	253	280	-	-	-	12	12
 <p>Tall unit for appliances niche height 1225 mm 1 flap door 1 appliance door 1 deep drawer <i>For cladding up to the ceiling, provision must be made for a ventilation opening of min. 200 cm² in diameter.</i></p> <p>CG122A 01 HVKSNI</p>	CG122A	01	HVK	214	228	241	253	282	300	324	5	8	16	10	20
 <p>Tall unit for appliances Niche height 450 mm 1 hinged door with Tip-On fitting 1 adjustable shelf 2 deep drawers <i>One front panel per appliance type will be provided for adaptation on site.</i> For foil-wrapped fronts a set of heat deflector plates are supplied free of charge.</p> <p>CGM2A 01 HEE</p>	CGM2A	01	H	224	231	239	247	260	269	284	10	16	32	4	4
 <p>Tall unit for appliances with lift-up door Recess height 422 mm same as above, but plus 1 lift-up door Maximum size of stand-alone Height 370 mm Width 510 mm Depth: 540 mm 430 mm opening height for lift-up door</p> <p>CGM2A 01 HL</p>	CGM2A	01	HL	291	300	311	321	338	349	370	10	16	32	4	4

5.78 Illustrations do not correspond to front finishes / Door buffer = flap door stay buffer

Appliance housings with niche height 450 mm

1971 mm high

Unit without plinth, carcass depth 560 mm

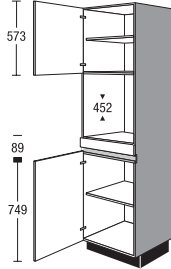
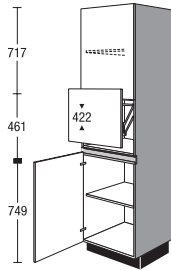
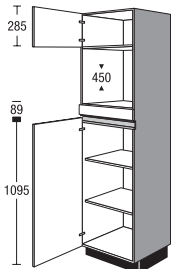
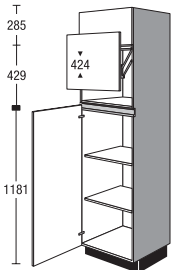
		width	Price group							Servosoft	Pro Servosoft	ProServoglass	Soft closing Top Motion	Soft closing Top Motion Plus	
			1	2	3	4	5	6	7						
 <p>Tall unit for appliances Recess height 452 mm</p> <p>1 hinged door with Tip-On fitting 1 adjustable shelf 1 fixed front panel 1 hinged door 1 adjustable shelf</p> <p><i>One front panel per appliance type will be provided for adaptation on site.</i></p> <p><i>For cladding up to the ceiling, provision must be made for a ventilation opening of min. 200 cm² in diameter.</i></p> <p>CGM 01 HEE</p>	CGM	01	H	211	222	230	241	257	270	284	-	-	-	8	8
	 <p>Tall unit for appliances with lift-up door Recess height 422 mm</p> <p>same as above, but plus 1 lift-up door</p> <p>Maximum size of stand-alone Height 370 mm Width 510 mm Depth: 540 mm</p> <p>430 mm opening height for lift-up door</p> <p>CGM 01 HL</p>	CGM	01	HL	274	288	300	313	335	351	371	-	-	-	8
 <p>Tall unit for appliances Niche height 450 mm</p> <p>1 hinged door with Tip-On fitting 1 fixed front panel 1 hinged door 2 adjustable shelves</p> <p><i>One front panel per appliance type will be provided for adaptation on site.</i></p> <p><i>For cladding up to the ceiling, provision must be made for a ventilation opening of min. 200 cm² in diameter.</i></p> <p>CGM 01 H6EE</p>		CGM	01	H6	191	201	209	219	234	245	258	-	-	-	10
	 <p>Tall unit for appliances with lift-up door Recess height 424 mm</p> <p>same as above, but no fixed front panel plus 1 lift-up door</p> <p>Maximum size of stand-alone Height 370 mm Width 510 mm Depth: 540 mm</p> <p>430 mm opening height for lift-up door</p> <p>CGM 01 HL8</p>	CGM	01	HL8	258	272	283	296	317	331	349	-	-	-	10

Illustrations do not correspond to front finishes / Door buffer = flap door stay buffer

5.79

Appliance housings with niche height 450 mm, Appliance housings with niche height 590 mm

1971 mm high

Unit without plinth, carcass depth 560 mm

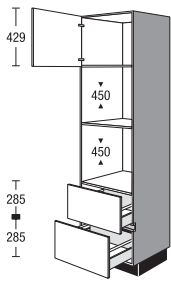
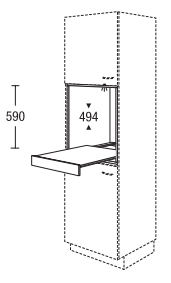
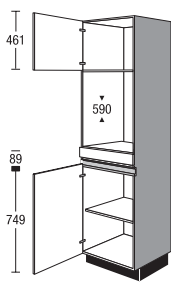
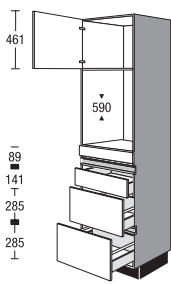
	CGMM2A	width	01	HX	Price group							Servosoft	Pro Servosoft	ProServoGlass	Soft closing Top Motion	Soft closing Top Motion Plus
					1	2	3	4	5	6	7					
 <p>Tall unit for appliances Niche height 450 mm Niche height 450 mm</p> <p>1 hinged door with Tip-On fitting 2 deep drawers</p> <p><i>One front panel per appliance type will be provided for adaptation on site.</i></p> <p><i>Version supplied may deviate from the illustration according to appliance type.</i></p> <p><i>For cladding up to the ceiling, provision must be made for a ventilation opening of min. 200 cm² in diameter.</i></p> <p>CGMM2A 01 HXKE</p>					236	251	262	274	296	318	346	10	16	32	4	4
 <p>Modular built in shelf unit for highboard / tall unit</p> <p>for niche heights 590 mm Depth: 505 mm</p> <p>1 pull-out shelf</p> <p><i>Finish in carcass material</i></p> <p><i>Not available in visible side colours.</i></p>	MR	60	59	TA	201	201	201	201	201	201	201	-	-	-	-	-
 <p>Tall unit for appliances niche height 590 mm</p> <p>1 hinged door with Tip-On fitting 1 fixed front panel 1 hinged door 1 adjustable shelf</p> <p><i>For foil-wrapped fronts a set of heat deflector plates are supplied free of charge.</i></p> <p>CGB 01 HFB</p>	CGB		01	H	201	208	216	224	237	246	260	-	-	-	8	8
 <p>Tall unit for appliances niche height 590 mm</p> <p>1 hinged door with Tip-On fitting 1 fixed front panel 1 drawer 2 deep drawers</p> <p><i>For foil-wrapped fronts a set of heat deflector plates are supplied free of charge.</i></p> <p>CGBS2A 01 HFB</p>	CGBS2A		01	H	273	287	301	314	337	362	394	15	24	40	4	4

5.80

Illustrations do not correspond to front finishes / Door buffer = flap door stay buffer

Appliance housings with niche height 590 mm

1971 mm high

Unit without plinth, carcass depth 560 mm

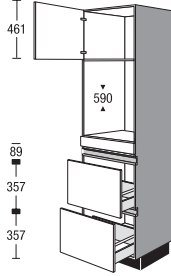
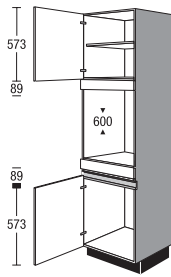
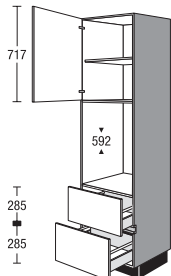
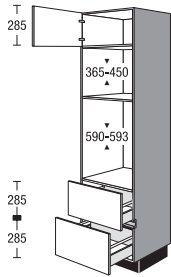
	width	Price group							Servosoft	Pro Servosoft	ProServoglass	Soft closing Top Motion	Soft closing Top Motion Plus		
		1	2	3	4	5	6	7							
 <p>Tall unit for appliances niche height 590 mm</p> <p>1 hinged door with Tip-On fitting 1 fixed front panel 2 deep drawers</p> <p><i>For foil-wrapped fronts a set of heat deflector plates are supplied free of charge.</i></p> <p>CGB2A 01 HFB</p>	CGB2A	01	H	252	265	278	290	311	334	363	10	16	32	4	4
 <p>Tall unit for appliances niche height 600 mm</p> <p>1 hinged door with Tip-On fitting 1 adjustable shelf 1 fixed front panel 1 fixed front panel 1 hinged door</p> <p><i>For foil-wrapped fronts a set of heat deflector plates are supplied free of charge.</i></p> <p>CGB 01 HXFB</p>	CGB	01	HX	196	204	211	219	232	241	255	-	-	-	8	8
 <p>Tall unit for appliances Niche height 592 mm</p> <p>1 hinged door with Tip-On fitting 1 adjustable shelf 2 deep drawers</p> <p><i>One front panel per appliance type will be provided for adaptation on site.</i></p> <p><i>For foil-wrapped fronts a set of heat deflector plates are supplied free of charge.</i></p> <p>CGB2A 01 HXFB</p>	CGB2A	01	HX	242	255	268	279	300	323	351	10	16	32	4	4
 <p>Tall unit for appliances Recess height 365 - 450 mm Recess height 590 - 593 mm</p> <p>1 hinged door 285 or 357 mm with Tip-On fitting 2 deep drawers</p> <p><i>One front panel per appliance type will be provided for adaptation on site.</i></p> <p><i>For foil-wrapped fronts a set of heat deflector plates are supplied free of charge.</i></p> <p>CGMB2A 01 HXLD</p>	CGMB2A	01	HX	241	255	267	278	300	323	350	10	16	32	4	4

Illustrations do not correspond to front finishes / Door buffer = flap door stay buffer

5.81

Appliance housings with niche height 590 mm, Shelf units, Fillers

1971 mm high

Unit without plinth, carcass depth 560 mm

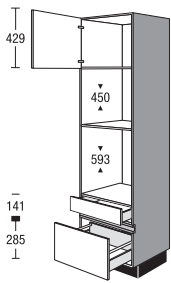
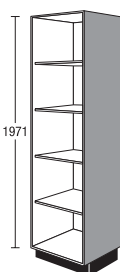
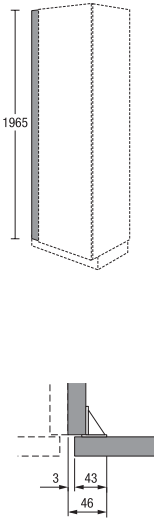
	CGMBSA	width	01	H	Price group							Servosoft	Pro Servosoft	ProServoGlass	Soft closing Top Motion	Soft closing Top Motion Plus
					1	2	3	4	5	6	7					
 <p>Tall unit for appliances Niche height 450 mm Niche height 593 mm 1 hinged door with Tip-On fitting 1 drawer 1 deep drawer For foil-wrapped fronts a set of heat deflector plates are supplied free of charge.</p> <p>CGMBSA 01 HLD</p>	CGMBSA		01	H	234	249	260	272	293	315	343	10	16	24	4	4
 <p>Tall shelf unit 4 adjustable shelves Finish in carcass material Please indicate desired width (150-600 mm). Not available in visible side colours.</p>	☑ CSR	V	01		227	227	227	227	227	227	227	-	-	-	-	-
 <p>Infill panel for tall unit without plinth, 1971 mm high Fitted between wall and carcass side Finish in continuous door material without edging on the wall side Not available in visible side colours. Due to the installation angle, the maximum possible on-site width reduction is 46 mm. Available for the following fronts: IP 2200, Vintage oak effect no. 138 IP 2200, Light oak effect no. 141 IP 2200, Oregon oak effect no. 142 IP 2200, Oak effect black no. 143 IP 2200, Summerfield oak effect no. 163</p>	CSPF CSPF	10 20	01 01	E E	29 37	33 40	34 42	35 45	37 52	40 57	45 63	-	-	-	-	-

Fillers

1971 mm high

with neutral door division

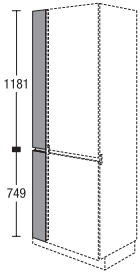
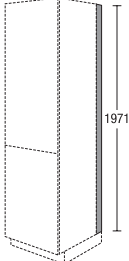
		width	Price group							Servosoft	Pro Servosoft	ProServoglass	Soft closing Top Motion	Soft closing Top Motion Plus		
			1	2	3	4	5	6	7							
 <p>Infill panel for tall unit without plinth, 1971 mm high With horizontal handle profile Fitted between wall and carcass side</p> <p><i>Finish in door material without edging on the wall side</i></p> <p><i>Not available in visible side colours.</i></p> <p><i>The delivery is made in two parts.</i></p> <p><i>Due to the installation angle, the maximum possible on-site width reduction is 46 mm.</i></p>	CSPF	10	01	H	64	70	72	74	77	83	89	-	-	-	-	-
	CSPF	20	01	H	70	76	78	80	84	103	123	-	-	-	-	-
 <p>Infill panel for tall-unit side without plinth, 1971 mm high 16 mm deep for wall end</p> <p><i>Finish laminate, stainless steel look</i></p> <p><i>for deeper tops, order plinth SO 151 separately</i></p>	CDTS		01		11	11	11	11	11	11	11	-	-	-	-	-

Illustrations do not correspond to front finishes / Door buffer = flap door stay buffer

5.83

Tall units

2115 mm high

Unit without plinth, carcass depth 560 mm

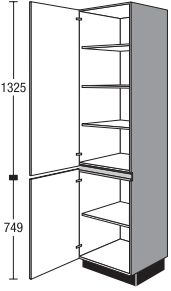
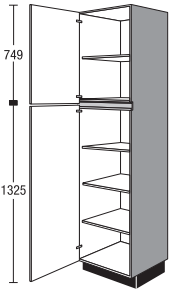
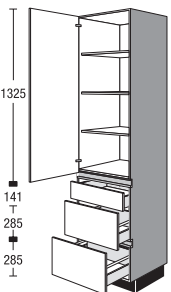
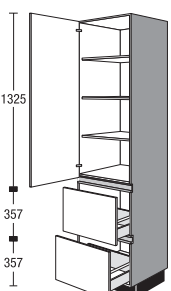
			width			Price group							Servosoft	Pro Servosoft	ProServoGlass	Soft closing Top Motion	Soft closing Top Motion Plus
						1	2	3	4	5	6	7					
 <p>Tall unit 1 hinged door 3 adjustable shelves 1 hinged door 1 adjustable shelf</p> <p>1325 749</p>	<input checked="" type="checkbox"/>	CS	30	02	H	140	150	157	165	184	200	222	-	-	-	10	10
	<input checked="" type="checkbox"/>	CS	45	02	H	175	185	194	204	226	245	271	-	-	-	10	10
	<input checked="" type="checkbox"/>	CS	50	02	H	177	186	195	204	225	243	269	-	-	-	10	10
	<input checked="" type="checkbox"/>	CS	60	02	H	182	194	204	214	235	254	280	-	-	-	10	10
 <p>Tall unit 1 hinged door 1 adjustable shelf 1 hinged door 3 adjustable shelves</p> <p>749 1325</p>	<input checked="" type="checkbox"/>	CS	30	02	H9	140	150	157	165	184	200	222	-	-	-	10	10
	<input checked="" type="checkbox"/>	CS	45	02	H9	175	185	194	204	226	245	271	-	-	-	10	10
	<input checked="" type="checkbox"/>	CS	50	02	H9	177	186	195	204	225	243	269	-	-	-	10	10
	<input checked="" type="checkbox"/>	CS	60	02	H9	182	194	204	214	235	254	280	-	-	-	10	10
 <p>Tall unit for crockery 1 hinged door 3 adjustable shelves 1 drawer 2 deep drawers</p> <p>1325 141 285 285</p>	<input checked="" type="checkbox"/>	CSS2A	30	02	H	193	203	210	219	236	252	276	15	24	40	6	6
	<input checked="" type="checkbox"/>	CSS2A	45	02	H	231	243	252	263	284	302	330	15	24	40	6	6
	<input checked="" type="checkbox"/>	CSS2A	50	02	H	240	252	261	273	295	314	343	15	24	40	6	6
	<input checked="" type="checkbox"/>	CSS2A	60	02	H	249	261	271	282	305	325	355	15	24	40	6	6
 <p>Tall unit 1 hinged door 3 adjustable shelves 2 deep drawers</p> <p>1325 357 357</p> <p><i>Width can be shortened down to 300 mm</i></p>	<input checked="" type="checkbox"/>	CS2A	50	02	H	227	238	247	257	277	297	324	10	16	32	6	6
	<input checked="" type="checkbox"/>	CS2A	60	02	H	233	245	254	265	286	305	333	10	16	32	6	6

Tall units

2115 mm high

Unit without plinth, carcass depth 560 mm

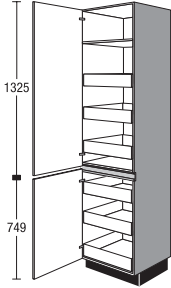
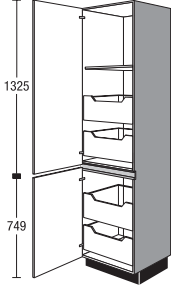
				width	Price group							Servosoft	Pro Servosoft	ProServoglass	Soft closing Top Motion	Soft closing Top Motion Plus	
					1	2	3	4	5	6	7						
 <p>Tall unit 1 hinged door 1 fixed shelf 3 interior drawers</p> <p><i>The hinged doors must open to an angle of at least 90°. Door must not be hinged on side adjacent to the worktop.</i></p>	<input checked="" type="checkbox"/>	CS	30	02	HIS	274	294	307	322	353	377	409	30	48	48	10	10
	<input checked="" type="checkbox"/>	CS	45	02	HIS	316	339	354	372	408	436	472	30	48	48	10	10
	<input checked="" type="checkbox"/>	CS	50	02	HIS	322	346	364	382	417	445	479	30	48	48	10	10
	<input checked="" type="checkbox"/>	CS	60	02	HIS	324	348	367	386	420	449	483	30	48	48	10	10
 <p>Tall unit 1 hinged door 1 fixed shelf 2 interior deep drawers</p> <p><i>The hinged doors must open to an angle of at least 90°. Door must not be hinged on side adjacent to the worktop.</i></p>	<input checked="" type="checkbox"/>	CS	30	02	HIA	243	258	270	282	313	337	372	20	32	64	10	10
	<input checked="" type="checkbox"/>	CS	45	02	HIA	285	303	317	331	368	396	437	20	32	64	10	10
	<input checked="" type="checkbox"/>	CS	50	02	HIA	288	306	320	336	369	397	436	20	32	64	10	10
	<input checked="" type="checkbox"/>	CS	60	02	HIA	293	311	325	342	374	404	444	20	32	64	10	10



Illustrations do not correspond to front finishes / Door buffer = flap door stay buffer

5.85

Tall units

2115 mm high

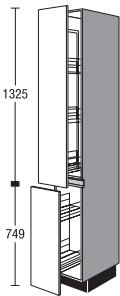





Unit without plinth, carcass depth 560 mm

	CSA	width	02	H	Price group							Servosoft	Pro Servosoft	ProServoGlass	Soft closing Top Motion	Soft closing Top Motion Plus
					1	2	3	4	5	6	7					
 <p>Pull-out tall unit with cushioning 1 full-extension pull-out with cushioning 3 adjustable baskets 1 full-extension pull-out with cushioning 2 adjustable baskets <i>Equipment feature baskets: wire parts silver grey</i></p>  <p>Baskets: clip-on baskets silver grey</p> <p>Suitable additions:</p> <p>Hanging basket silver-grey</p> <p>Insert tray plastic white 12 mm high</p>	CSA	30	02	H	405	422	425	428	444	452	474	-	-	-	-	-
	ZIK	30			6	6	6	6	6	6	6	-	-	-	-	-
	ZIE	30			3	3	3	3	3	3	3	-	-	-	-	-

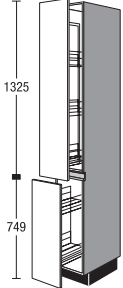
Tall units

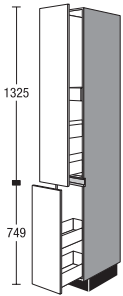
2115 mm high

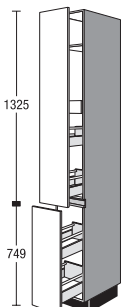
Unit without plinth, carcass depth 560 mm

		width		Price group							Servosoft	Pro Servosoft	ProServoglass	Soft closing Top Motion	Soft closing Top Motion Plus	
				1	2	3	4	5	6	7						
 <p>Pull-out tall unit with cushioning 1 full-extension pull-out with cushioning 3 adjustable baskets 1 full-extension pull-out with cushioning 2 adjustable Arena shelves</p> <p><i>Runner profile top and bottom Baskets can be used from both sides.</i></p> <p><i>Basket features: Comfortline, wooden base with metal railing</i></p> <p><i>Supplementary unit information: Including full pull-out with cushioning</i></p> <p>Note unit information.</p>  <p>Baskets: wooden shelf and metal rail</p> <p>Suitable additions:</p> <p>Hanging basket Wooden shelf with metal rail</p>	CSA	30	02	HP	456	473	476	479	495	503	528	-	-	-	-	-
	ZIK	30		P	7	7	7	7	7	7	7	-	-	-	-	-
 <p>Tall unit </p> <p>1 deep drawer with 2 drawers 1 internal drawer 1 deep drawer with 2 drawers</p>	CSA	30	02	HS	217	231	233	237	243	253	272	25	40	40	-	-
 <p>Tall unit </p> <p>1 Auszug mit 2 Auszügen 1 interior deep drawer 1 Auszug mit 2 Auszügen</p>	CSA	30	02	HA	229	244	246	250	256	267	287	25	40	72	-	-

Illustrations do not correspond to front finishes / Door buffer = flap door stay buffer

5.87

Appliance housings with niche height 880 mm

2115 mm high

Unit without plinth, carcass depth 560 mm

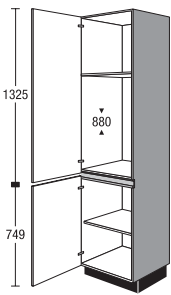
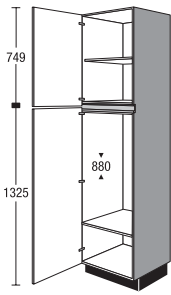
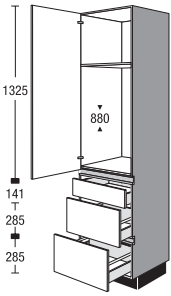
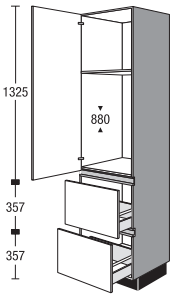
	CG88	width	02	H	Price group							Servosoft	Pro Servosoft	ProServoGlass	Soft closing Top Motion	Soft closing Top Motion Plus
					1	2	3	4	5	6	7					
 <p>Tall unit for appliances Niche height 880 mm</p> <ul style="list-style-type: none"> 1 hinged appliance door 1 fixed shelf 1 hinged door 1 adjustable shelf <p><i>For cladding up to the ceiling, provision must be made for a ventilation opening of min. 200 cm² in diameter.</i></p> <p>CG88 02 HSI A</p>	CG88		02	H	176	187	200	213	244	270	304	-	-	-	12	12
 <p>Tall unit for appliances Niche height 880 mm</p> <ul style="list-style-type: none"> 1 hinged door 1 adjustable shelf 1 hinged appliance door 1 fixed shelf <p><i>For cladding up to the ceiling, provision must be made for a ventilation opening of min. 200 cm² in diameter.</i></p> <p>CG88 02 H9 SIA</p>	CG88		02	H9	176	187	200	213	244	270	304	-	-	-	12	12
 <p>Tall unit for appliances Niche height 880 mm</p> <ul style="list-style-type: none"> 1 hinged appliance door 1 fixed shelf 1 drawer 2 deep drawers <p><i>For cladding up to the ceiling, provision must be made for a ventilation opening of min. 200 cm² in diameter.</i></p> <p>CG88S2A 02 HSI A</p>	CG88S2A		02	H	244	255	270	284	309	337	372	15	24	40	6	6
 <p>Tall unit for appliances Niche height 880 mm</p> <ul style="list-style-type: none"> 1 hinged appliance door 1 fixed shelf 2 deep drawers <p><i>For cladding up to the ceiling, provision must be made for a ventilation opening of min. 200 cm² in diameter.</i></p> <p>CG882A 02 HSI A</p>	CG882A		02	H	227	237	251	264	287	313	346	10	16	32	8	8

5.88

Illustrations do not correspond to front finishes / Door buffer = flap door stay buffer

Appliance housings with niche height 880 mm, Appliance housings with niche height 1025 mm

2115 mm high

Unit without plinth, carcass depth 560 mm

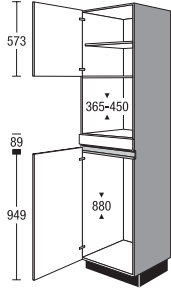
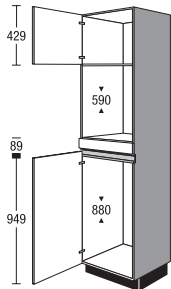
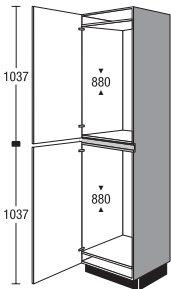
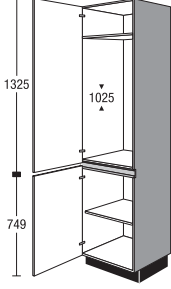
		width	Price group							Servosoft	Pro Servosoft	ProServoglass	Soft closing Top Motion	Soft closing Top Motion Plus	
			1	2	3	4	5	6	7						
 <p>Tall unit for appliances Recess height 365 - 450 mm Niche height 880 mm</p> <p>1 hinged door with Tip-On fitting 1 adjustable shelf 1 fixed front panel 1 appliance door</p> <p><i>One front panel per appliance type will be provided for adaptation on site.</i></p> <p><i>Recess sizes are adjusted in part through the use of carcass panels.</i></p> <p><i>Version supplied may deviate from the illustration according to appliance type.</i></p>	CG88M	02	H4	191	202	207	213	240	259	284	-	-	-	10	10
	CG88M 02 H4S0A														
 <p>Tall unit for appliances niche height 590 mm Niche height 880 mm</p> <p>1 hinged door with Tip-On fitting 1 fixed front panel 1 hinged appliance door</p> <p><i>One front panel per appliance type will be provided for adaptation on site.</i></p> <p><i>Recess sizes are adjusted in part through the use of carcass panels.</i></p> <p><i>Version supplied may deviate from the illustration according to appliance type.</i></p> <p><i>For foil-wrapped fronts a set of heat deflector plates are supplied free of charge.</i></p>	CG88B	02	H4	188	200	205	211	239	260	285	-	-	-	10	10
	CG88B 02 H4SPF														
 <p>Tall unit for appliances Niche height 880 mm Niche height 880 mm</p> <p>1 appliance door 1 appliance door</p> <p><i>For cladding up to the ceiling, provision must be made for a ventilation opening of min. 200 cm² in diameter.</i></p>	CG8888	02	H5	184	202	213	228	255	280	311	-	-	-	12	12
	CG8888 02 H5STB														
 <p>Tall unit for appliances niche height 1025 mm</p> <p>1 hinged appliance door 1 fixed shelf 1 hinged door 1 adjustable shelf</p> <p><i>For cladding up to the ceiling, provision must be made for a ventilation opening of min. 200 cm² in diameter.</i></p>	CG102	02	H	176	177	189	203	233	253	292	-	-	-	10	10
	CG102 02 HSLC														

Illustrations do not correspond to front finishes / Door buffer = flap door stay buffer

5.89

Appliance housings with niche height 1025 mm

2115 mm high

Unit without plinth, carcass depth 560 mm

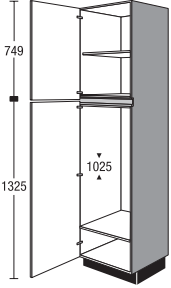
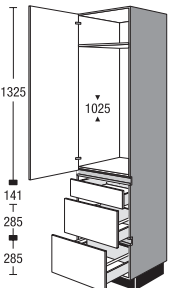
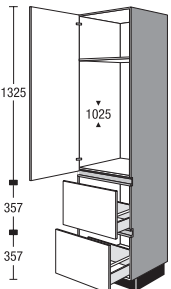
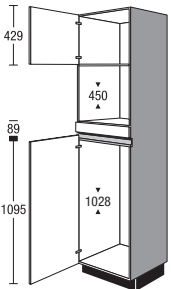
	CG	width	02	H9	Price group							Servosoft	Pro Servosoft	ProServoGlass	Soft closing Top Motion	Soft closing Top Motion Plus
					1	2	3	4	5	6	7					
 <p>Tall unit for appliances niche height 1025 mm</p> <p>1 hinged door 1 adjustable shelf 1 hinged appliance door 1 fixed shelf</p> <p><i>For cladding up to the ceiling, provision must be made for a ventilation opening of min. 200 cm² in diameter.</i></p> <p>CG102 02 H9SLC</p>	CG102		02	H9	176	177	189	203	233	253	292	-	-	-	10	10
 <p>Tall unit for appliances niche height 1025 mm</p> <p>1 hinged appliance door 1 fixed shelf 1 drawer 2 deep drawers</p> <p><i>For cladding up to the ceiling, provision must be made for a ventilation opening of min. 200 cm² in diameter.</i></p> <p>CG102S2A 02 HSLC</p>	CG102S2A		02	H	247	258	273	287	313	341	376	15	24	40	6	6
 <p>Tall unit for appliances niche height 1025 mm</p> <p>1 hinged appliance door 1 fixed shelf 2 deep drawers</p> <p><i>For cladding up to the ceiling, provision must be made for a ventilation opening of min. 200 cm² in diameter.</i></p> <p>CG1022A 02 HSLC</p>	CG1022A		02	H	227	237	251	264	287	313	346	10	16	32	6	6
 <p>Tall unit for appliances Niche height 450 mm Recess height 1028 mm</p> <p>1 hinged door with Tip-On fitting 1 fixed front panel 1 appliance door</p> <p><i>One front panel per appliance type will be provided for adaptation on site.</i></p> <p><i>Version supplied may deviate from the illustration according to appliance type.</i></p> <p><i>For cladding up to the ceiling, provision must be made for a ventilation opening of min. 200 cm² in diameter.</i></p> <p>CG102M 02 H6SPH</p>	CG102M		02	H6	190	201	206	212	240	259	285	-	-	-	10	10

5.90

Illustrations do not correspond to front finishes / Door buffer = flap door stay buffer

Appliance housings with niche height 1225 mm

2115 mm high

Unit without plinth, carcass depth 560 mm

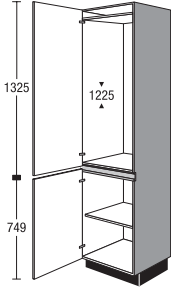
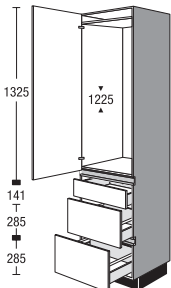
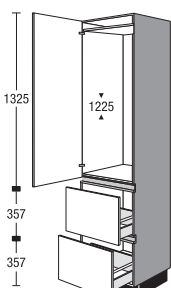
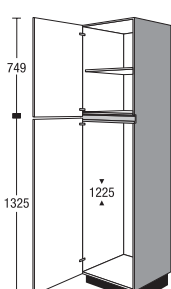
	width	Price group							Servosoft	Pro Servosoft	ProServoglass	Soft closing Top Motion	Soft closing Top Motion Plus		
		1	2	3	4	5	6	7							
 <p>Tall unit for appliances niche height 1225 mm 1 hinged appliance door 1 hinged door 1 adjustable shelf</p> <p><i>For cladding up to the ceiling, provision must be made for a ventilation opening of min. 200 cm² in diameter.</i></p> <p>CG122 02 HSNL</p>	CG122	02	H	176	187	200	213	244	270	304	-	-	-	10	10
 <p>Tall unit for appliances niche height 1225 mm 1 hinged appliance door 1 drawer 2 deep drawers</p> <p><i>For cladding up to the ceiling, provision must be made for a ventilation opening of min. 200 cm² in diameter.</i></p> <p>CG122S2A 02 HSNL</p>	CG122S2A	02	H	247	258	273	287	313	341	376	15	24	40	6	6
 <p>Tall unit for appliances niche height 1225 mm 1 hinged appliance door 2 deep drawers</p> <p><i>For cladding up to the ceiling, provision must be made for a ventilation opening of min. 200 cm² in diameter.</i></p> <p>CG1222A 02 HSNL</p>	CG1222A	02	H	227	237	251	264	287	313	346	10	16	32	6	6
 <p>Tall unit for appliances niche height 1225 mm 1 hinged door 1 adjustable shelf 1 appliance door</p> <p><i>niche size adjustment partially with infill panels.</i></p> <p><i>Version supplied may deviate from the illustration according to appliance type.</i></p> <p><i>For cladding up to the ceiling, provision must be made for a ventilation opening of min. 200 cm² in diameter.</i></p> <p>CG122 02 H9SNL</p>	CG122	02	H9	176	177	189	203	233	253	292	-	-	-	10	10

Illustrations do not correspond to front finishes / Door buffer = flap door stay buffer

5.91

Appliance housings with niche height 450 mm

2115 mm high

Unit without plinth, carcass depth 560 mm

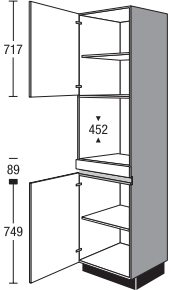
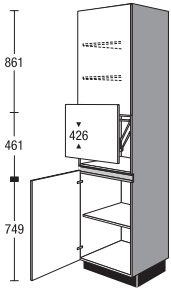
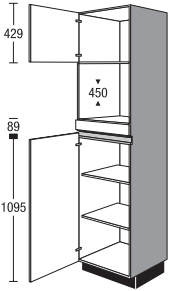
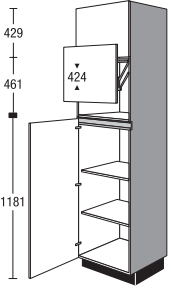
		width	Price group							Servosoft	Pro Servosoft	ProServoGlass	Soft closing Top Motion	Soft closing Top Motion Plus	
			1	2	3	4	5	6	7						
 <p>Tall unit for appliances Recess height 452 mm</p> <p>1 hinged door 1 adjustable shelf 1 fixed front panel 1 hinged door 1 adjustable shelf</p> <p><i>One front panel per appliance type will be provided for adaptation on site.</i></p> <p><i>Version supplied may deviate from the illustration according to appliance type.</i></p> <p><i>For cladding up to the ceiling, provision must be made for a ventilation opening of min. 200 cm² in diameter.</i></p> <p>CGM 02 HEE</p>	CGM	02	H	215	227	235	246	265	277	294	-	-	-	8	8
	 <p>Tall unit for appliances with lift-up door Recess height 426 mm</p> <p>same as above, but no fixed front panel plus 1 lift-up door</p> <p>Maximum size of stand-alone Height 370 mm Width 510 mm Depth: 540 mm</p> <p>430 mm opening height for lift-up door</p> <p>CGM 02 HL</p>	CGM	02	HL	277	293	304	318	344	360	381	-	-	-	8
 <p>Tall unit for appliances Niche height 450 mm</p> <p>1 hinged door 1 fixed front panel 1 hinged door 2 adjustable shelves</p> <p><i>One front panel per appliance type will be provided for adaptation on site.</i></p> <p><i>Version supplied may deviate from the illustration according to appliance type.</i></p> <p><i>For cladding up to the ceiling, provision must be made for a ventilation opening of min. 200 cm² in diameter.</i></p> <p>CGM 02 H6EE</p>		CGM	02	H6	199	209	218	228	247	257	273	-	-	-	10
	 <p>Tall unit for appliances with lift-up door Recess height 424 mm</p> <p>same as above, but no fixed front panel plus 1 lift-up door</p> <p>Maximum size of stand-alone Height 400 mm Width 510 mm Depth: 540 mm</p> <p>430 mm opening height for lift-up door</p> <p>CGM 02 HL8</p>	CGM	02	HL8	258	272	283	296	317	331	349	-	-	-	10

Appliance housings with niche height 450 mm, Appliance housings with niche height 590 mm

2115 mm high

Unit without plinth, carcass depth 560 mm

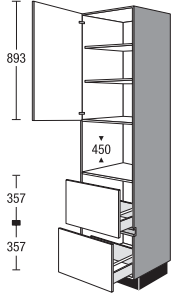
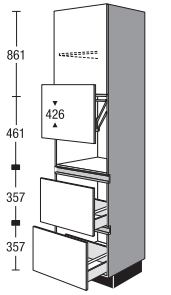
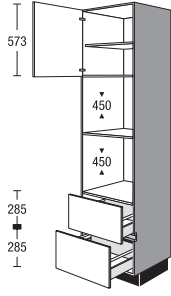
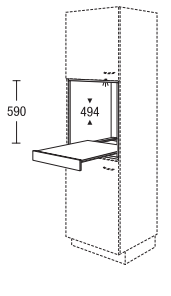
	width	Price group							Servosoft	Pro Servosoft	ProServoglass	Soft closing Top Motion	Soft closing Top Motion Plus		
		1	2	3	4	5	6	7							
 <p>Tall unit for appliances Niche height 450 mm 1 hinged door with Tip-On fitting 2 adjustable shelves 2 deep drawers</p> <p>CGM2A 02 HEE</p>	CGM2A	02	H	222	231	240	250	267	277	295	10	16	32	4	4
 <p>Tall unit for appliances with lift-up door Recess height 426 mm same as above, but plus 1 lift-up door</p> <p>Maximum size of stand-alone Height 370 mm Width 510 mm Depth: 540 mm</p> <p>430 mm opening height for lift-up door</p> <p>CGM2A 02 HL</p>	CGM2A	02	HL	289	301	313	325	348	362	384	10	16	32	4	4
 <p>Tall unit for appliances Niche height 450 mm Niche height 450 mm 1 hinged door with Tip-On fitting 1 adjustable shelf 2 deep drawers</p> <p><i>Version supplied may deviate from the illustration according to appliance type.</i></p> <p><i>For cladding up to the ceiling, provision must be made for a ventilation opening of min. 200 cm² in diameter.</i></p> <p>CGMM2A 02 HXKE</p>	CGMM2A	02	HX	243	263	273	283	296	318	345	10	16	32	4	4
 <p>Modular built in shelf unit for highboard / tall unit for niche heights 590 mm Depth: 505 mm</p> <p>1 pull-out shelf</p> <p><i>Finish in carcass material</i></p> <p><i>Not available in visible side colours.</i></p> <p>MR</p>	MR	60	59	TA	201	201	201	201	201	201	-	-	-	-	-

Illustrations do not correspond to front finishes / Door buffer = flap door stay buffer

5.93

Appliance housings with niche height 590 mm

2115 mm high

Unit without plinth, carcass depth 560 mm

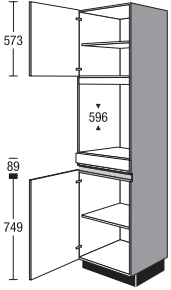
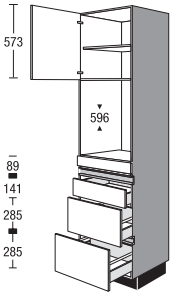
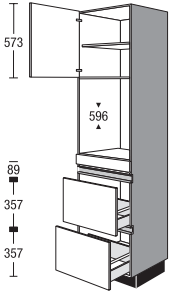
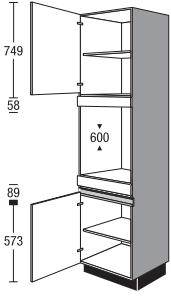
	width	Price group							Servosoft	Pro Servosoft	ProServoGlass	Soft closing Top Motion	Soft closing Top Motion Plus		
		1	2	3	4	5	6	7							
 <p>Tall unit for appliances Recess height 596 mm</p> <p>1 hinged door with Tip-On fitting 1 adjustable shelf 1 fixed front panel 1 hinged door 1 adjustable shelf</p> <p><i>Niche sizes are partly adjusted with front or carcass panels.</i></p> <p><i>One front panel per appliance type will be provided for adaptation on site.</i></p> <p><i>For foil-wrapped fronts a set of heat deflector plates are supplied free of charge.</i></p> <p>CGB 02 HFB</p>	CGB	02	H	209	219	228	237	254	265	282	-	-	-	8	8
 <p>Tall unit for appliances Recess height 596 mm</p> <p>1 hinged door with Tip-On fitting 1 adjustable shelf 1 fixed front panel 1 drawer 2 deep drawers</p> <p><i>For foil-wrapped fronts a set of heat deflector plates are supplied free of charge.</i></p> <p>CGBS2A 02 HFB</p>	CGBS2A	02	H	291	313	327	341	365	391	422	15	24	40	4	4
 <p>Tall unit for appliances Recess height 596 mm</p> <p>1 hinged door with Tip-On fitting 1 adjustable shelf 1 fixed front panel 2 deep drawers</p> <p><i>For foil-wrapped fronts a set of heat deflector plates are supplied free of charge.</i></p> <p><i>Niche sizes are partly adjusted with front or carcass panels.</i></p> <p>CGB2A 02 HFB</p>	CGB2A	02	H	273	294	307	320	342	366	396	10	16	32	4	4
 <p>Tall unit for appliances niche height 600 mm</p> <p>1 hinged door with Tip-On fitting 1 adjustable shelf 1 fixed front panel 1 fixed front panel 1 hinged door 1 adjustable shelf</p> <p><i>For foil-wrapped fronts a set of heat deflector plates are supplied free of charge.</i></p> <p>CGB 02 HXFB</p>	CGB	02	HX	221	230	239	249	266	276	294	-	-	-	8	8

5.94

Illustrations do not correspond to front finishes / Door buffer = flap door stay buffer

Appliance housings with niche height 590 mm, Shelf units

2115 mm high

Unit without plinth, carcass depth 560 mm

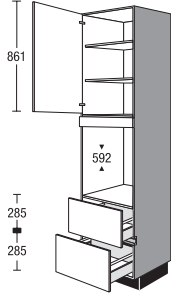
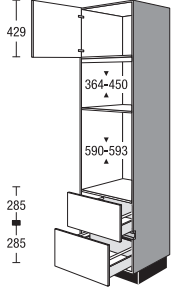
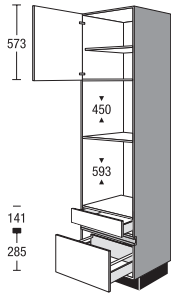
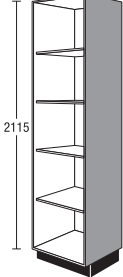
		Price group							Servosoft	Pro Servosoft	ProServodiamond	Soft closing Top Motion	Soft closing Top Motion Plus		
		width	1	2	3	4	5	6						7	
 <p>Tall unit for appliances Niche height 592 mm</p> <p>1 hinged door with Tip-On fitting 1 adjustable shelf 1 fixed front panel 2 deep drawers</p> <p><i>One front panel per appliance type will be provided for adaptation on site.</i></p> <p><i>For cladding up to the ceiling, provision must be made for a ventilation opening of min. 200 cm² in diameter.</i></p> <p><i>Niche sizes are partly adjusted with front or carcass panels.</i></p> <p>CGB2A 02 HXFB</p>	CGB2A	02	HX	252	273	285	297	318	340	369	10	16	32	4	4
	 <p>Tall unit for appliances Recess height 364 - 450 mm Recess height 590 - 593 mm</p> <p>1 hinged door with Tip-On fitting 2 deep drawers</p> <p><i>Niche sizes are partly adjusted with front or carcass panels.</i></p> <p><i>One front panel per appliance type will be provided for adaptation on site.</i></p> <p><i>For cladding up to the ceiling, provision must be made for a ventilation opening of min. 200 cm² in diameter.</i></p> <p><i>For foil-wrapped fronts a set of heat deflector plates are supplied free of charge.</i></p> <p>CGMB2A 02 HXLA</p>	CGMB2A	02	HX	248	268	277	288	300	323	349	10	16	32	4
 <p>Tall unit for appliances Niche height 450 mm Niche height 593 mm</p> <p>1 hinged door with Tip-On fitting 1 adjustable shelf 1 drawer 1 deep drawer</p> <p><i>For foil-wrapped fronts a set of heat deflector plates are supplied free of charge.</i></p> <p>CGMBSA 02 HLD</p>	CGMBSA	02	H	241	261	271	281	299	320	347	10	16	24	4	4
 <p>Tall shelf unit</p> <p>4 adjustable shelves</p> <p><i>Finish in carcass material</i></p> <p><i>Please indicate desired width (150-600 mm).</i></p> <p><i>Not available in visible side colours.</i></p>	CSR	V	02	234	234	234	234	234	234	234	234	-	-	-	-

Illustrations do not correspond to front finishes / Door buffer = flap door stay buffer

5.95

Fillers

2115 mm high

with neutral door division

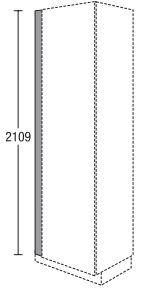
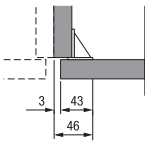
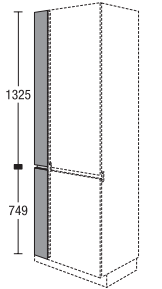
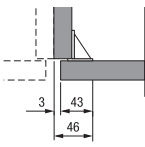
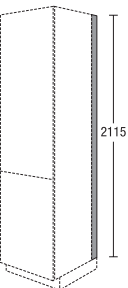
						Price group											
		width				1	2	3	4	5	6	7	Servosoft	Pro-Servosoft	ProServoGlass	Soft closing Top Motion	Soft closing Top Motion Plus
 <p>Infill panel for tall unit without plinth, 2115 mm high Fitted between wall and carcass side</p> <p><i>Finish in continuous door material without edging on the wall side</i></p> <p><i>Not available for the following fronts:</i> IP 2200, Vintage oak effect no. 138 IP 2200, Light oak effect no. 141 IP 2200, Oregon oak effect no. 142 IP 2200, Oak effect black no. 143 IP 2200, Summerfield oak effect no. 163</p> <p><i>Not available in visible side colours.</i></p> <p><i>Due to the installation angle, the maximum possible on-site width reduction is 46 mm.</i></p> 	CSPF	10	02	E		30	33	35	36	38	42	46	-	-	-	-	-
	CSPF	20	02	E		41	44	47	49	54	59	65	-	-	-	-	-
 <p>Infill panel for tall unit without plinth, 2115 mm high With horizontal handle profile Fitted between wall and carcass side</p> <p><i>Finish in door material without edging on the wall side</i></p> <p><i>Not available in visible side colours.</i></p> <p><i>The delivery is made in two parts.</i></p> <p><i>Due to the installation angle, the maximum possible on-site width reduction is 46 mm.</i></p> 	CSPF	10	02	H		67	73	76	78	81	84	90	-	-	-	-	-
	CSPF	20	02	H		73	80	84	86	91	96	104	-	-	-	-	-
 <p>Infill panel for tall-unit side without plinth, 2115 mm high 16 mm deep for wall end</p> <p><i>Finish laminate, stainless steel look</i></p> <p><i>for deeper tops, order plinth SO 151 separately</i></p>	CDTS		02			12	12	12	12	12	12	12	-	-	-	-	-

Tall units

2259 mm high

Unit without plinth, carcass depth 560 mm

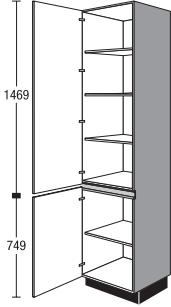
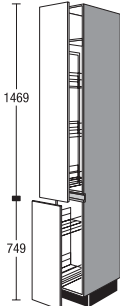
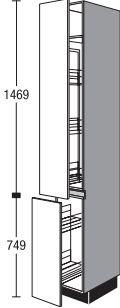
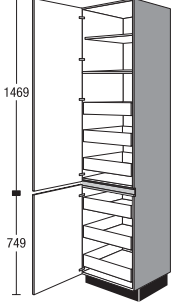
						Price group											
				width		1	2	3	4	5	6	7	Servosoft	Pro Servosoft	ProServodglass	Soft closing Top Motion	Soft closing Top Motion Plus
 <p>Tall unit 1 hinged door 3 adjustable shelves 1 hinged door 1 adjustable shelf</p>		CS	30	03	H	155	166	172	180	199	215	237	-	-	-	12	12
		CS	45	03	H	184	195	205	217	241	262	291	-	-	-	12	12
		CS	50	03	H	189	198	208	217	241	259	287	-	-	-	12	12
		CS	60	03	H	193	209	220	231	255	276	303	-	-	-	12	12
 <p>Pull-out tall unit with cushioning 1 full-extension pull-out with cushioning 1 fixed shelf 3 adjustable baskets 1 full-extension pull-out with cushioning 2 adjustable Arena shelves</p> <p><i>Runner profile top and bottom Baskets can be used from both sides.</i></p> <p><i>Basket features: Comfortline, wooden base with metal railing</i></p>		CSA	30	03	HP	463	482	487	491	509	522	550	-	-	-	-	-
 <p>Pull-out tall unit with cushioning 1 full-extension pull-out with cushioning 1 fixed shelf 3 adjustable baskets 1 full-extension pull-out with cushioning 2 adjustable baskets</p> <p><i>Runner profile top and bottom Baskets can be used from both sides.</i></p> <p><i>Equipment feature baskets: wire parts silver grey</i></p>		CSA	30	03	H	413	432	437	441	459	472	496	-	-	-	-	-
 <p>Tall unit 1 hinged door 1 adjustable shelf 1 fixed shelf 3 interior drawers 1 hinged door 3 interior drawers</p> <p><i>The hinged doors must open to an angle of at least 90°. Door must not be hinged on side adjacent to the worktop.</i></p>		CS	30	03	HIS	280	300	313	328	360	384	417	30	48	48	12	12
		CS	45	03	HIS	321	344	359	377	413	441	477	30	48	48	12	12
		CS	50	03	HIS	327	351	369	387	422	450	484	30	48	48	12	12
		CS	60	03	HIS	329	353	372	391	425	454	488	30	48	48	12	12





Illustrations do not correspond to front finishes / Door buffer = flap door stay buffer

5.97

Tall units

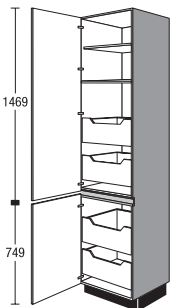
2259 mm high

Unit without plinth, carcass depth 560 mm

						Price group											
				width		1	2	3	4	5	6	7	ServoSoft	Pro ServoSoft	ProServoGlass	Soft closing Top Motion	Soft closing Top Motion Plus
 <p>Tall unit 1 hinged door 1 adjustable shelf 1 fixed shelf 2 interior deep drawers 1 hinged door 2 exterior deep drawers</p> <p><i>The hinged doors must open to an angle of at least 90°. Door must not be hinged on side adjacent to the worktop.</i></p>		CS	30	03	HIA	249	264	276	288	320	345	381	20	32	64	12	12
		CS	45	03	HIA	290	308	322	336	374	402	444	20	32	64	12	12
		CS	50	03	HIA	293	311	325	341	374	402	441	20	32	64	12	12
		CS	60	03	HIA	298	316	330	347	379	409	449	20	32	64	12	12

Appliance housings with niche height 880 mm, Appliance housings with niche height 1025 mm

2259 mm high

Unit without plinth, carcass depth 560 mm

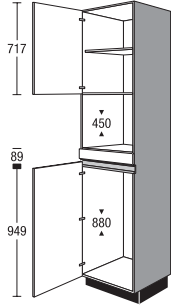
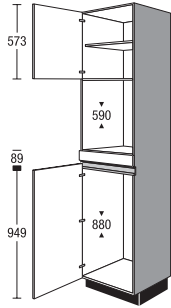
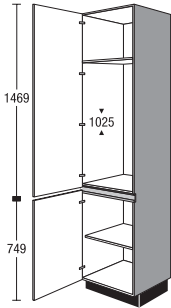
				Price group												
		width			1	2	3	4	5	6	7	Servosoft	Pro Servosoft	ProServoglass	Soft closing Top Motion	Soft closing Top Motion Plus
 <p>Tall unit for appliances NEW Recess height 365 - 450 mm Niche height 880 mm</p> <p>1 hinged door with Tip-On fitting 1 adjustable shelf 1 fixed front panel 1 appliance door</p> <p><i>One front panel per appliance type will be provided for adaptation on site.</i></p> <p><i>Recess sizes are adjusted in part through the use of carcass panels.</i></p> <p><i>Version supplied may deviate from the illustration according to appliance type.</i></p> <p>CG88M 03 H4S0A</p>	CG88M	03	H4	196	207	212	218	246	265	291	-	-	-	10	10	
	 <p>Tall unit for appliances NEW niche height 590 mm Niche height 880 mm</p> <p>1 hinged door with Tip-On fitting 1 adjustable shelf 1 fixed front panel 1 fixed front panel 1 hinged appliance door</p> <p><i>One front panel per appliance type will be provided for adaptation on site.</i></p> <p><i>Recess sizes are adjusted in part through the use of carcass panels.</i></p> <p><i>Version supplied may deviate from the illustration according to appliance type.</i></p> <p><i>For foil-wrapped fronts a set of heat deflector plates are supplied free of charge.</i></p> <p>CG88B 03 H4</p>	CG88B	03	H4	193	205	210	216	245	267	293	-	-	-	10	10
		 <p>Tall unit for appliances niche height 1025 mm</p> <p>1 hinged appliance door 1 fixed shelf 1 hinged door 1 adjustable shelf</p> <p><i>For cladding up to the ceiling, provision must be made for a ventilation opening of min. 200 cm² in diameter.</i></p> <p>CG102 03 HSLC</p>	CG102	03	H	184	187	189	205	238	254	301	-	-	-	12

Illustrations do not correspond to front finishes / Door buffer = flap door stay buffer

5.99

Appliance housings with niche height 1025 mm, Appliance housings with niche height 1225 mm, Appliance housings with niche height 450 mm

2259 mm high

Unit without plinth, carcass depth 560 mm

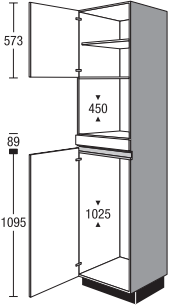
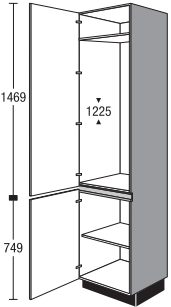
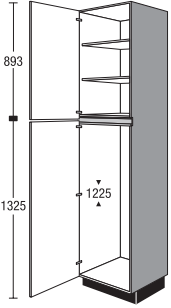
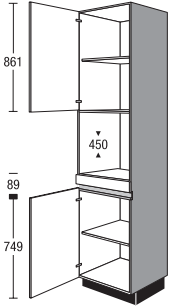
	width	Price group							Servosoft	Pro Servosoft	ProServoGlass	Soft closing Top Motion	Soft closing Top Motion Plus		
		1	2	3	4	5	6	7							
 <p>Tall unit for appliances Niche height 450 mm niche height 1025 mm</p> <p>1 hinged door with Tip-On fitting 1 fixed front panel 1 appliance door</p> <p><i>One front panel per appliance type will be provided for adaptation on site.</i></p> <p><i>Version supplied may deviate from the illustration according to appliance type.</i></p> <p><i>For cladding up to the ceiling, provision must be made for a ventilation opening of min. 200 cm² in diameter.</i></p> <p>CG102M 03 H6SPH</p>	CG102M	03	H6	197	208	213	220	250	266	294	-	-	-	10	10
 <p>Tall unit for appliances niche height 1225 mm</p> <p>1 hinged door 1 adjustable shelf 1 hinged appliance door</p> <p><i>For cladding up to the ceiling, provision must be made for a ventilation opening of min. 200 cm² in diameter.</i></p> <p>CG122 03 HSNL</p>	CG122	03	H	182	195	198	213	247	269	311	-	-	-	12	12
 <p>Tall unit for appliances niche height 1225 mm</p> <p>1 hinged door 2 adjustable shelves 1 appliance door</p> <p><i>niche size adjustment partially with infill panels.</i></p> <p><i>Version supplied may deviate from the illustration according to appliance type.</i></p> <p><i>For cladding up to the ceiling, provision must be made for a ventilation opening of min. 200 cm² in diameter.</i></p> <p>CG122 03 H9SNL</p>	CG122	03	H9	182	195	198	213	247	269	311	-	-	-	12	12
 <p>Tall unit for appliances Niche height 450 mm</p> <p>1 hinged door 1 adjustable shelf 1 fixed front panel 1 hinged door 1 adjustable shelf</p> <p><i>One front panel per appliance type will be provided for adaptation on site.</i></p> <p><i>Version supplied may deviate from the illustration according to appliance type.</i></p> <p><i>For cladding up to the ceiling, provision must be made for a ventilation opening of min. 200 cm² in diameter.</i></p> <p>CGM 03 HEE</p>	CGM	03	H	222	235	243	254	276	287	307	-	-	-	8	8

5.100 Illustrations do not correspond to front finishes / Door buffer = flap door stay buffer

Appliance housings with niche height 450 mm, Appliance housings with niche height 590 mm

2259 mm high

Unit without plinth, carcass depth 560 mm

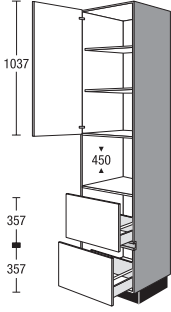
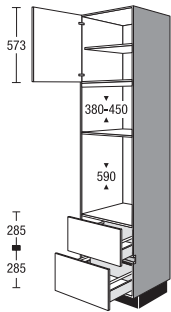
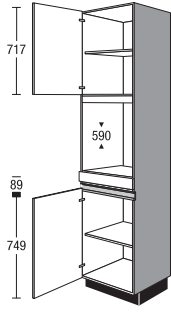
		Price group													
		width	1	2	3	4	5	6	7	Servosoft	Pro Servosoft	ProServodglass	Soft closing Top Motion	Soft closing Top Motion Plus	
 <p>Tall unit for appliances Niche height 450 mm</p> <p>1 hinged door with Tip-On fitting 2 adjustable shelves 2 deep drawers</p> <p>CGM2A 03 HEE</p>	CGM2A	03	H	220	231	241	253	274	285	306	10	16	32	4	4
 <p>Tall unit for appliances Recess height 380 - 450 mm niche height 590 mm</p> <p>1 hinged door with Tip-On fitting 1 adjustable shelf 2 deep drawers</p> <p><i>Niche sizes are partly adjusted with front or carcass panels.</i></p> <p><i>One front panel per appliance type will be provided for adaptation on site.</i></p> <p><i>For cladding up to the ceiling, provision must be made for a ventilation opening of min. 200 cm² in diameter.</i></p> <p><i>For foil-wrapped fronts a set of heat deflector plates are supplied free of charge.</i></p> <p>CGMB2A 03 HXLA</p>	CGMB2A	03	HX	255	281	287	298	300	323	348	10	16	32	4	4
 <p>Tall unit for appliances niche height 590 mm</p> <p>1 hinged door with Tip-On fitting 1 adjustable shelf 1 fixed front panel 1 hinged door 1 adjustable shelf</p> <p><i>Niche sizes are partly adjusted with front or carcass panels.</i></p> <p><i>One front panel per appliance type will be provided for adaptation on site.</i></p> <p><i>For foil-wrapped fronts a set of heat deflector plates are supplied free of charge.</i></p> <p>CGB 03 HFB</p>	CGB	03	H	217	230	240	250	271	284	304	-	-	-	8	8

Illustrations do not correspond to front finishes / Door buffer = flap door stay buffer

5.101

Appliance housings with niche height 590 mm, Fillers

2259 mm high

Unit without plinth, carcass depth 560 mm

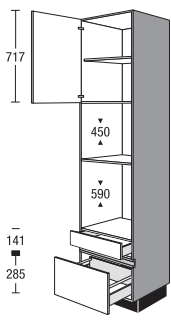
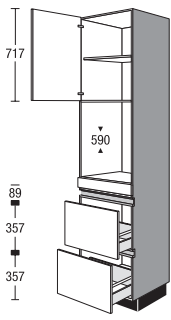
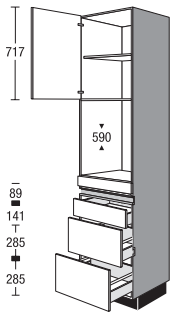
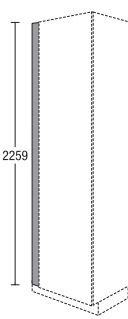
	CGMBSA	width	03	H	Price group							Servosoft	Pro Servosoft	ProServoGlass	Soft closing Top Motion	Soft closing Top Motion Plus
					1	2	3	4	5	6	7					
 <p>Tall unit for appliances Niche height 450 mm niche height 590 mm</p> <p>1 hinged door with Tip-On fitting 1 adjustable shelf 1 drawer 1 deep drawer</p> <p><i>For foil-wrapped fronts a set of heat deflector plates are supplied free of charge.</i></p> <p>CGMBSA 03 HLD</p>	CGMBSA		03	H	248	273	282	290	305	325	351	10	16	24	4	4
 <p>Tall unit for appliances niche height 590 mm</p> <p>1 hinged door with Tip-On fitting 1 adjustable shelf 1 fixed front panel 2 deep drawers</p> <p><i>For foil-wrapped fronts a set of heat deflector plates are supplied free of charge.</i></p> <p><i>Niche sizes are partly adjusted with front or carcass panels.</i></p> <p>CGB2A 03 HFB</p>	CGB2A		03	H	294	323	336	350	373	398	429	10	16	32	4	4
 <p>Tall unit for appliances niche height 590 mm</p> <p>1 hinged door with Tip-On fitting 1 adjustable shelf 1 fixed front panel 1 drawer 2 deep drawers</p> <p><i>For foil-wrapped fronts a set of heat deflector plates are supplied free of charge.</i></p> <p>CGBS2A 03 HFB</p>	CGBS2A		03	H	309	339	353	368	393	420	450	15	24	40	4	4
 <p>Infill panel for tall unit without plinth, 2259 mm high Fitted between wall and carcass side</p> <p><i>Finish in continuous door material without edging on the wall side</i></p> <p><i>Not available for the following fronts:</i> IP 2200, Vintage oak effect no. 138 IP 2200, Light oak effect no. 141 IP 2200, Oregon oak effect no. 142 IP 2200, Oak effect black no. 143 IP 2200, Summerfield oak effect no. 163</p> <p><i>Not available in visible side colours.</i></p> <p><i>Due to the installation angle, the maximum possible on-site width reduction is 46 mm.</i></p>	CSPF	10	03	E	31	33	36	37	39	44	47	-	-	-	-	-
	CSPF	20	03	E	45	48	52	53	56	61	67	-	-	-	-	-

Fillers

2259 mm high

with neutral door division

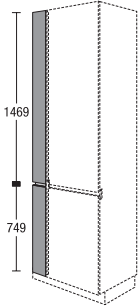
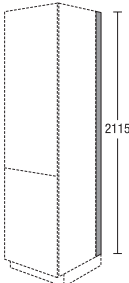
		width	Price group							Servosoft	Pro Servosoft	ProServoglass	Soft closing Top Motion	Soft closing Top Motion Plus		
			1	2	3	4	5	6	7							
 <p>Infill panel for tall unit without plinth, 2259 mm high With horizontal handle profile Fitted between wall and carcass side</p> <p><i>Finish in door material without edging on the wall side</i></p> <p><i>Not available in visible side colours.</i></p> <p><i>The delivery is made in two parts.</i></p> <p><i>Due to the installation angle, the maximum possible on-site width reduction is 46 mm.</i></p>	CSPF	10	03	H	70	76	80	82	85	88	91	-	-	-	-	-
	CSPF	20	03	H	76	84	90	92	98	100	102	-	-	-	-	-
 <p>Infill panel for tall-unit side without plinth, 2259 mm high 16 mm deep for wall end</p> <p><i>Finish laminate, stainless steel look</i></p> <p><i>for deeper tops, order plinth SO 151 separately</i></p>	CDTS		03		13	13	13	13	13	13	13	-	-	-	-	-

Illustrations do not correspond to front finishes / Door buffer = flap door stay buffer

5.103

Modules for raised dishwashers

1507 mm high

Unit without worktop and plinth, carcass depth 560 mm. Order worktop separately.

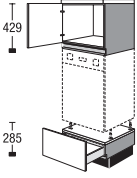
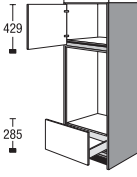
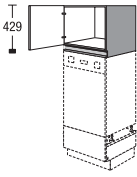
	width	Price group							Servosoft	Pro Servosoft	ProServoGlass	Soft closing Top Motion	Soft closing Top Motion Plus			
		1	2	3	4	5	6	7								
 <p>Modular unit for raised dishwasher</p> <p>Set comprising: 1 top unit with 1 hinged door 1 plinth base 1 base unit 147 mm high with 1 drawer 285 mm high 1 drip tray, silver grey</p> <p><i>Order dishwasher front panel (CTGV 60 S) and highboard cover separately.</i></p> <p><i>Max. appliance height 845 mm Not suitable for XXL appliances</i></p> <p><i>Please check whether dishwasher is approved for raised installation.</i></p> <p><i>The delivery comprises several packages.</i></p>	CGGS	151	H5	197	201	213	226	255	287	327	5	8	8	4	4	
 <p>Modular unit for raised dishwasher including panels</p> <p>to be placed under an integrated dishwasher, suitable for highboards</p> <p>Set comprising: 2 side modular panels (16 mm with panel support, 598 mm deep) 1 top unit with 1 hinged door 1 plinth base 1 base unit 147 mm high with 1 drawer 285 mm high 1 drip tray, silver grey</p> <p><i>Panel finish: Panel colours</i></p> <p><i>Order dishwasher front panel (CTGV 60 S) and highboard cover separately.</i></p> <p><i>Max. appliance height 845 mm Not suitable for XXL appliances</i></p> <p><i>Please check whether dishwasher is approved for raised installation.</i></p> <p><i>The delivery comprises several packages.</i></p>	CGGS63	151	H5	346	350	363	376	407	441	483	5	8	8	4	4	
 <p>Dresser unit</p> <p>as top unit on electrical appliances</p> <p>1 hinged door</p> <p><i>Can only be installed between modular panels or units.</i></p>	CA	60	49	H	76	80	84	87	96	104	114	-	-	-	4	4

Modules for raised dishwashers

1507 mm high

Unit without worktop and plinth, carcass depth 560 mm. Order worktop separately.

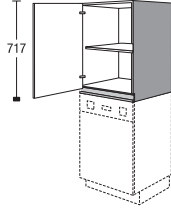
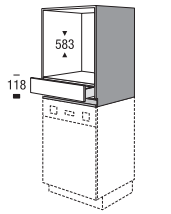
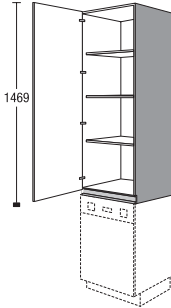
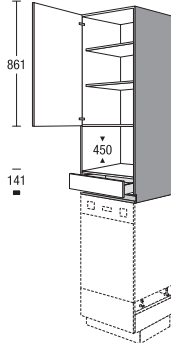
		width		Price group														
		1	2	3	4	5	6	7	Servosoft	Pro Servosoft	ProServoglass	Soft closing Top Motion	Soft closing Top Motion Plus					
 <p>Dresser unit as top unit on electrical appliances</p> <p>1 hinged door 1 adjustable shelf</p> <p><i>Can only be installed between modular panels or units.</i></p>	CA	60	78	H	105	109	115	119	131	142	156	-	-	-	4	4		
	 <p>Dresser unit Recess height 583 mm as top unit on electrical appliances</p> <p>1 drawer</p> <p><i>Can only be installed between modular panels or units.</i></p> <p><i>For foil-wrapped fronts a set of heat deflector plates are supplied free of charge.</i></p>	CABS		78	H	112	118	124	130	147	153	164	5	8	8	-	-	
		 <p>Dresser unit as top unit on electrical appliances</p> <p>1 hinged door 3 adjustable shelves</p> <p><i>Can only be installed between modular panels or units.</i></p>	CA	60	153	H	155	165	173	182	203	207	216	-	-	-	8	8
			 <p>Dresser unit Niche height 450 mm as top unit on electrical appliances</p> <p>1 hinged door with Tip-On fitting 2 adjustable shelves 1 drawer</p> <p><i>Can only be installed between modular panels or units.</i></p>	CAMS		153	H	183	196	207	220	246	272	305	5	8	8	4

Illustrations do not correspond to the door finishes.

5.105

Modules for raised dishwashers

1507 mm high

Unit without worktop and plinth, carcass depth 560 mm. Order worktop separately.

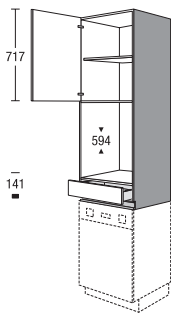
	width	Price group							Servosoft	Pro Servosoft	ProServoGlass	Soft closing Top Motion	Soft closing Top Motion Plus		
		1	2	3	4	5	6	7							
 <p>Dresser unit NEW</p> <p>Recess height 594 mm as top unit on electrical appliances</p> <p>1 hinged door with Tip-On fitting 1 adjustable shelf 1 drawer</p> <p><i>Can only be installed between modular panels or units.</i></p> <p><i>For foil-wrapped fronts a set of heat deflector plates are supplied free of charge.</i></p>	CABS	153	H	164	174	182	191	215	223	239	5	8	8	4	4



5.106

Illustrations do not correspond to the door finishes.

Modules for raised dishwashers

1971 mm high

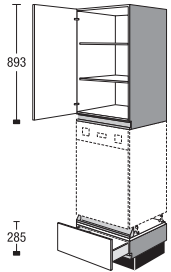
Unit without worktop and plinth, carcass depth 560 mm.

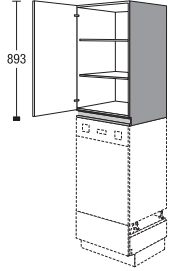
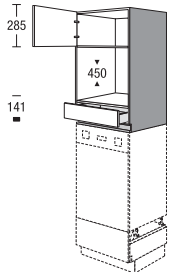

						Price group											
		width				1	2	3	4	5	6	7	Servosoft	Pro Servosoft	ProServoglass	Soft closing Top Motion	Soft closing Top Motion Plus
 <p>Modular unit for raised dishwasher Set comprising: 1 top unit with 1 hinged door 2 adjustable shelves 1 plinth platform with 1 drip tray, silver grey 1 base unit 147 mm high with 1 drawer 285 mm high</p> <p><i>Order dishwasher front panel and highboard cover separately.</i></p> <p><i>Max. appliance height 845 mm Not suitable for XXL appliances</i></p> <p><i>Please check whether dishwasher is approved for raised installation.</i></p> <p><i>The delivery comprises several packages.</i></p> 	CGGS	01	H5	251	262	270	279	302	308	320	5	8	8	4	4		
	 <p>Dresser unit as top unit on electrical appliances</p> <p>1 hinged door 2 adjustable shelves</p> <p><i>Can only be installed between modular panels or units.</i></p>	CA	60	95	H	124	132	139	146	163	166	174	-	-	-	4	4
	 <p>Dresser unit Niche height 450 mm as top unit on electrical appliances</p> <p>1 hinged door with Tip-On fitting 1 drawer</p> <p><i>Can only be installed between modular panels or units.</i></p>	CAMS	95	H	143	151	158	167	187	195	209	5	8	8	4	4	

Illustrations do not correspond to the door finishes.

Modules for raised dishwashers

1971 mm high

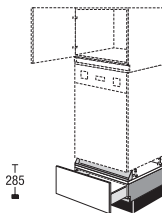
Unit without worktop and plinth, carcass depth 560 mm.

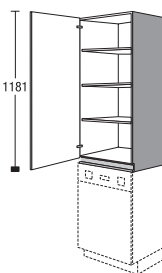
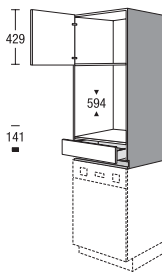
		width	Price group							Servosoft	Pro Servosoft	ProServoGlass	Soft closing Top Motion	Soft closing Top Motion Plus		
			1	2	3	4	5	6	7							
 <p>Base unit module For installing dishwashers</p> <p>1 drawer 1 drip tray, silver grey</p> <p><i>Top unit must be ordered separately.</i></p> <p><i>Order front panel and highboard cover separately.</i></p> <p><i>When using as a stand-alone or at the end of a run, a support panel or carcass material is required as cladding.</i></p> <p><i>Max. appliance height 845 mm</i></p> 	CUS	60	29	GS	138	141	142	145	150	153	158	5	8	8	-	-
 <p>Dresser unit as top unit on electrical appliances</p> <p>1 hinged door 3 adjustable shelves</p> <p><i>Can only be installed between modular panels or units.</i></p>	CA	60	124	H	144	153	162	169	189	192	202	-	-	-	6	6
 <p>Dresser unit Recess height 594 mm as top unit on electrical appliances</p> <p>1 hinged door 1 drawer</p> <p><i>Can only be installed between modular panels or units.</i></p> <p><i>For foil-wrapped fronts a set of heat deflector plates are supplied free of charge.</i></p>	CABS		124	H	152	160	169	177	199	207	222	5	8	8	4	4

5.108

Illustrations do not correspond to the door finishes.

Modules for raised dishwashers

1971 mm high

Unit without worktop and plinth, carcass depth 560 mm.

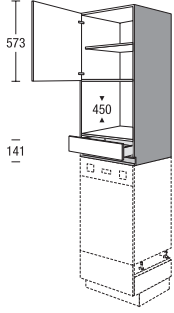
		width	Price group							Servosoft	Pro Servosoft	ProServoGlass	Soft closing Top Motion	Soft closing Top Motion Plus	
			1	2	3	4	5	6	7						
 <p>Dresser unit NEW</p> <p>Niche height 450 mm</p> <p>as top unit on electrical appliances</p> <p>1 hinged door with Tip-On fitting 1 adjustable shelf 1 drawer</p> <p><i>Can only be installed between modular panels or units.</i></p>	CAMS	124	H	159	171	181	193	217	241	271	5	8	8	4	4

Illustrations do not correspond to the door finishes.

5.109

Modules for raised dishwashers

2115 mm high

Unit without worktop and plinth, carcass depth 560 mm.

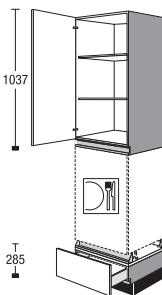
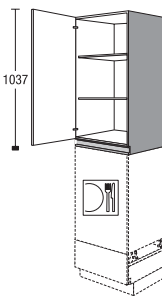
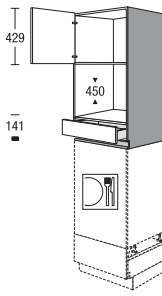
	CGGS	width	Price group							Servosoft	Pro Servosoft	ProServoGlass	Soft closing Top Motion	Soft closing Top Motion Plus		
			1	2	3	4	5	6	7							
 <p>Modular unit for raised dishwasher Set comprising: 1 top unit with 1 hinged door 2 adjustable shelves 1 plinth platform with 1 drip tray, silver grey 1 base unit 147 mm high with 1 drawer</p> <p><i>Order dishwasher front panel and highboard cover separately.</i></p> <p><i>Max. appliance height 845 mm Not suitable for XXL appliances</i></p> <p><i>Please check whether dishwasher is approved for raised installation.</i></p> <p><i>The delivery comprises several packages.</i></p>	02 H5		254	265	273	283	306	311	324	5	8	8	6	6		
 <p>Dresser unit as top unit on electrical appliances</p> <p>1 hinged door 2 adjustable shelves</p> <p><i>Can only be installed between modular panels or units.</i></p>	CA	60	110	H	126	135	142	149	167	169	177	-	-	-	6	6
 <p>Dresser unit Niche height 450 mm as top unit on electrical appliances</p> <p>1 hinged door with Tip-On fitting 1 drawer</p> <p><i>Can only be installed between modular panels or units.</i></p>	CAMS		110	H	146	154	162	170	191	198	213	5	8	8	4	4

5.110 Illustrations do not correspond to the door finishes.

Modules for raised dishwashers

2115 mm high

Unit without worktop and plinth, carcass depth 560 mm.

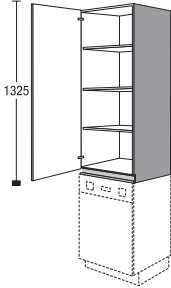
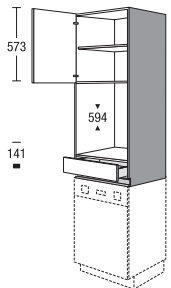
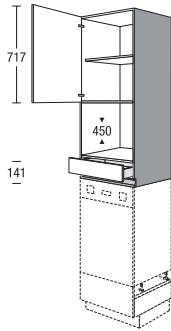
		width	Price group							Servosoft	Pro Servosoft	ProServoglass	Soft closing Top Motion	Soft closing Top Motion Plus			
			1	2	3	4	5	6	7								
 <p>Dresser unit as top unit on electrical appliances</p> <p>1 hinged door 3 adjustable shelves</p> <p><i>Can only be installed between modular panels or units.</i></p>	CA	60	139	H	150	160	168	177	197	201	210	-	-	-	6	6	
	 <p>Dresser unit Recess height 594 mm as top unit on electrical appliances</p> <p>1 hinged door with Tip-On fitting 1 adjustable shelf 1 drawer</p> <p><i>Can only be installed between modular panels or units.</i></p> <p><i>For foil-wrapped fronts a set of heat deflector plates are supplied free of charge.</i></p>	CABS		139	H	157	167	175	184	207	215	230	5	8	8	4	4
		 <p>Dresser unit Niche height 450 mm as top unit on electrical appliances</p> <p>1 hinged door with Tip-On fitting 1 adjustable shelf 1 drawer</p> <p><i>Can only be installed between modular panels or units.</i></p>	CAMS		139	H	170	183	194	206	232	258	290	5	8	8	4

Illustrations do not correspond to the door finishes.

5.111

Notes

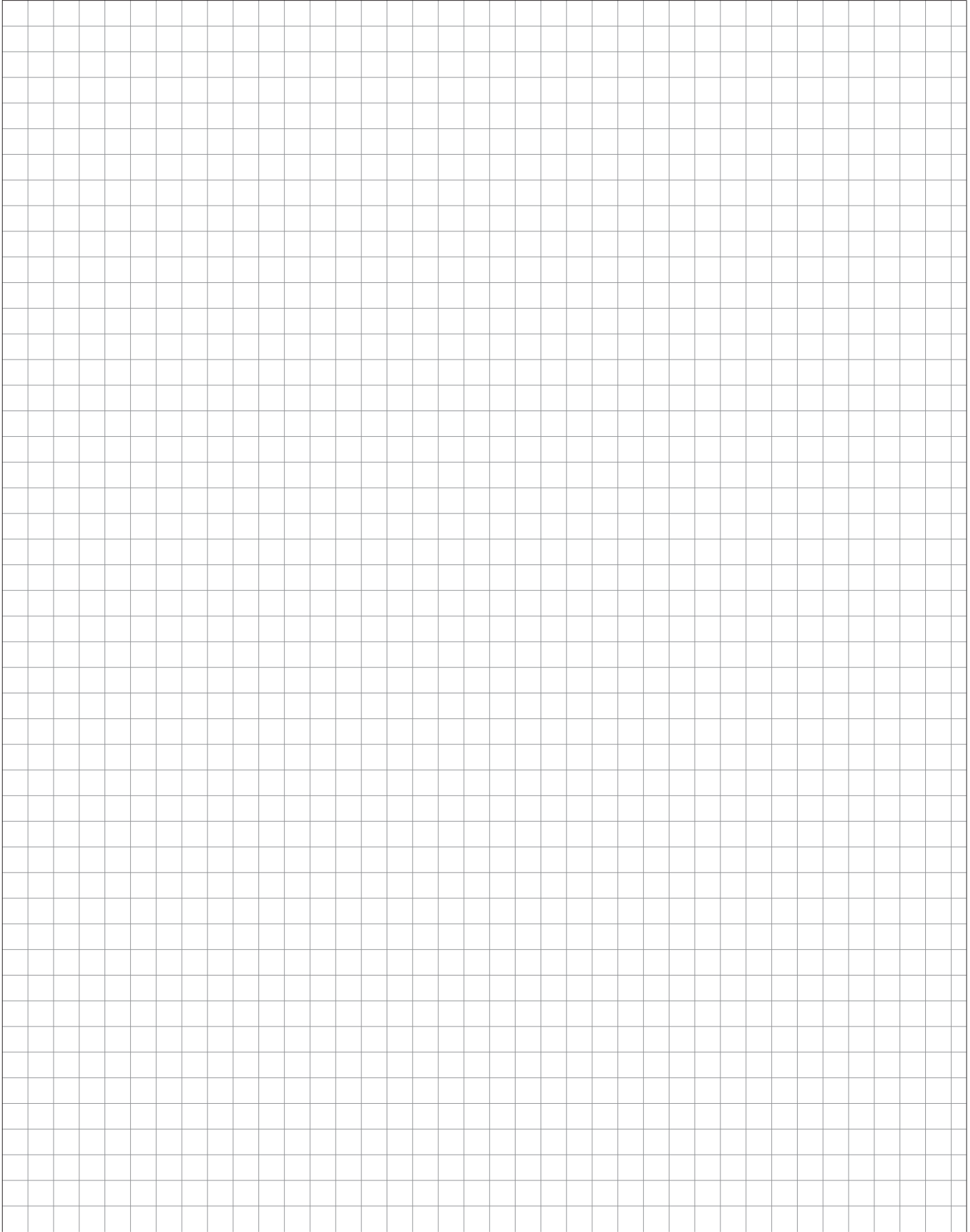

Highboards, tall units with vertical recessed grip

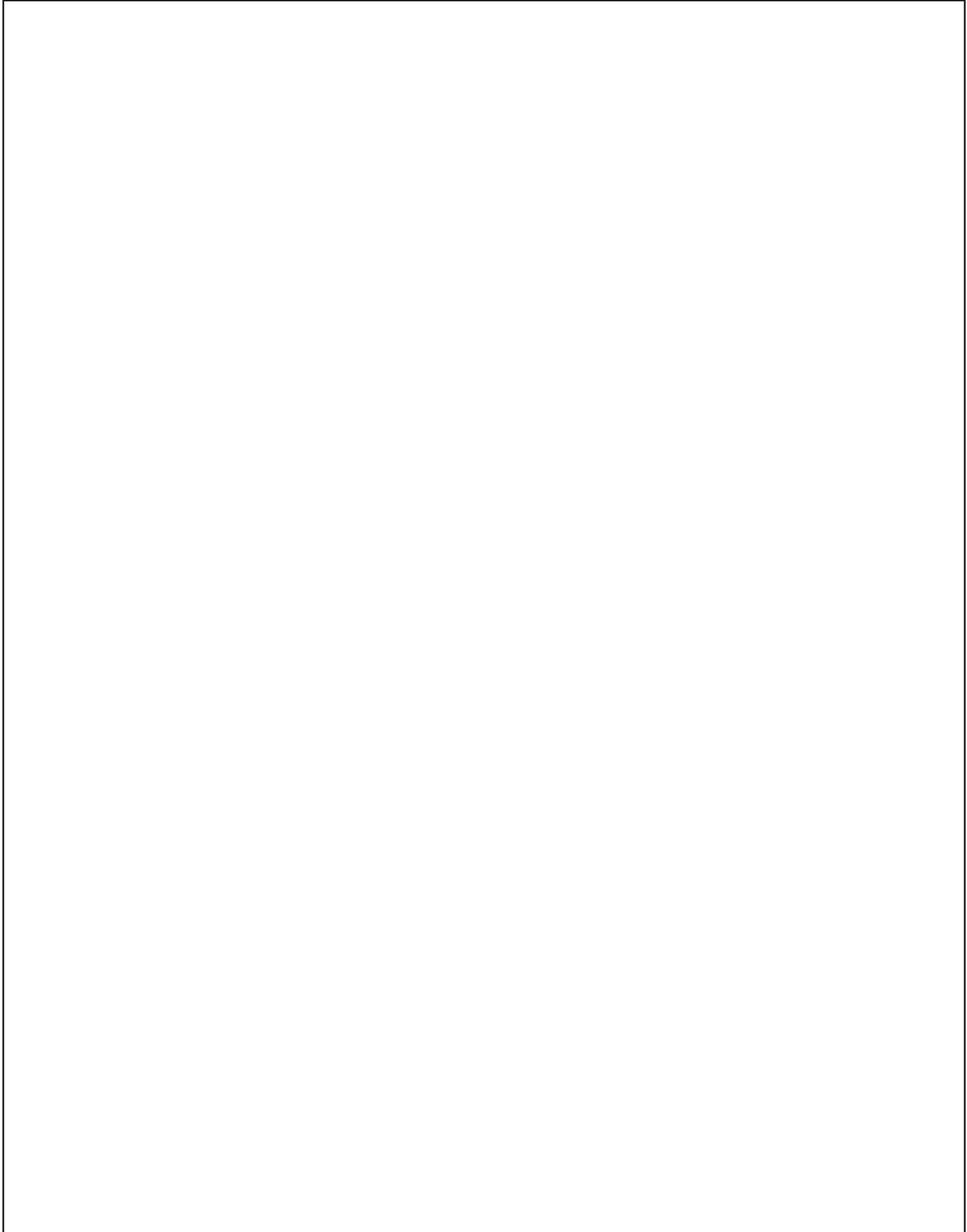

Highboards, tall units with
vertical recessed grip

Highboards, tall units with
vertical recessed grip

Summary of the most used/planned tall units

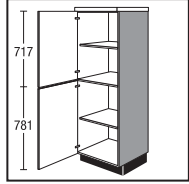

CS30151V
CS45151V
CS50151V
CS60151V

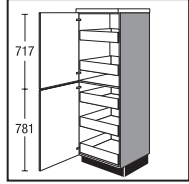

CS30151VIS
CS45151VIS
CS50151VIS
CS60151VIS

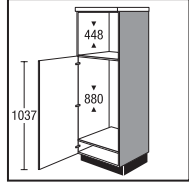

CG88M151V5

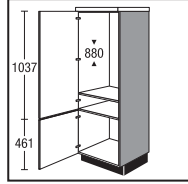

CG88151VQ

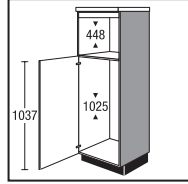

CG102M151V5

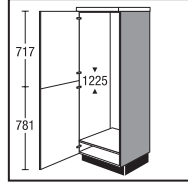

CG122151V

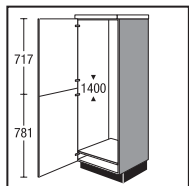

CG140151V

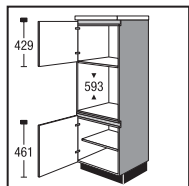

CGB151VQ

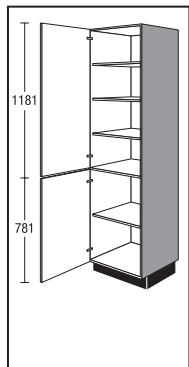

CS3001V
CS4501V
CS5001V
CS6001V

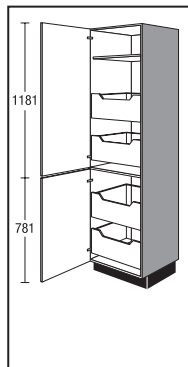

CS3001VIA
CS4501VIA
CS5001VIA
CS6001VIA

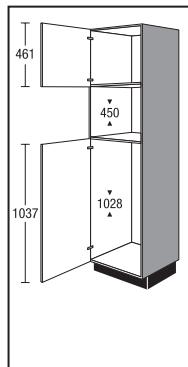

CG102M01V5

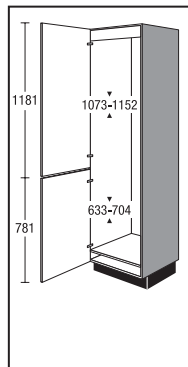

CG17801V

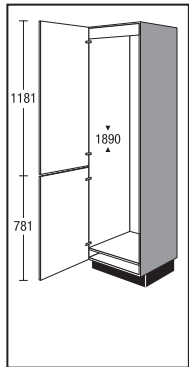

CG18901V

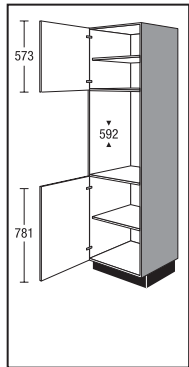

CGB01V

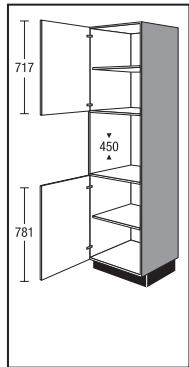

CGM01V

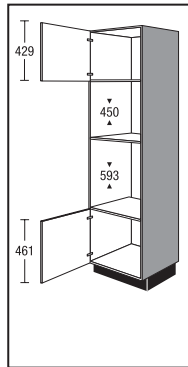

CGMB01VQ

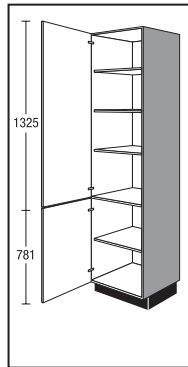

CS3002V
CS4502V
CS5002V
CS6002V

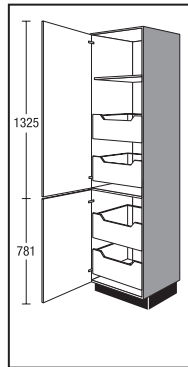

CS3002VIA
CS4502VIA
CS5002VIA
CS6002VIA

Summary of the most used/planned tall units

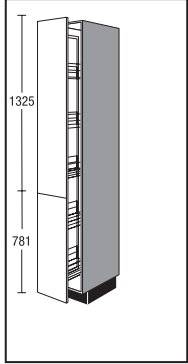

CSA3002VP

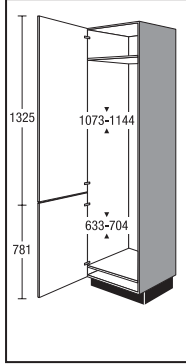

CG17802V

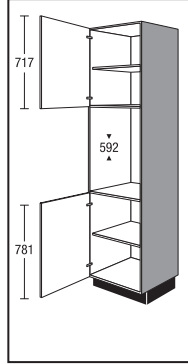

CGB02V

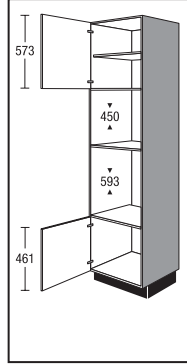

CGMB02VQ

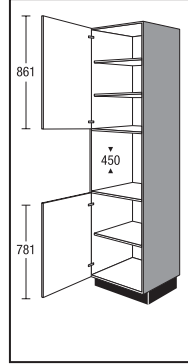

CGM02V

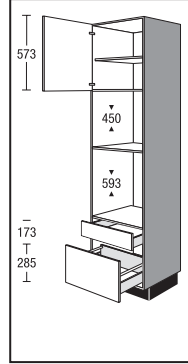

CGMBSA02VQ

Legend of symbols used, Equipment versions



Depth reduction

Surcharge for depth reduction at the end of the subsection.

Units shortened to the next smallest unit width available.
Example: unit width 600 mm = shortened to 501 mm



Depth reduction

For surcharges and information see register 9 Design elements, special topics, sub-register Surcharges/miscellaneous



Width and depth reduction

Combination of both variants

For surcharges and information see register 9 Design elements, special topics, sub-register Surcharges/miscellaneous

Information on customised products

Please note the possible customisations for cabinets.

The following individualisations are possible:

- Width reduction
- Depth reduction
- Carcase with increased side depth

You will find further information on this under register 9 Design elements, special topics, sub-register Surcharges/miscellaneous.



Drawers / deep drawers in standard finish TANDEMBOX plus

Colour silver grey

Version:

506 = full-extension pull-out with Servosoft (allow for surcharge!)



Drawers / deep drawers Professional (surcharge) TANDEMBOX antaro

Colour anthracite

Full-extension pull-out with Servosoft

Version:

508 = Professional full-extension pull-out with Servosoft



Drawers / deep drawers Professional with glass side (surcharge) TANDEMBOX antaro

Colour anthracite

Full-extension pull-out with Servosoft

Versions:

510 = Professional with Servosoft and clear glass

512 = Professional with Servosoft and frosted glass

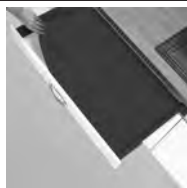

Non-slip mats

(surcharge per unit)

All drawers / deep drawers in a batch are fitted with the available non-slip mats

Drawer / deep drawer features:



Versions:

99 = Without non-slip mat

106 = Non-slip mat in silver-grey

108 = Non-slip mat in anthracite

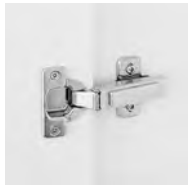









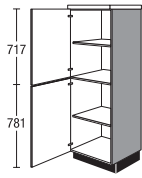



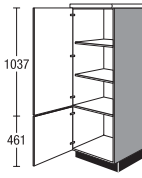

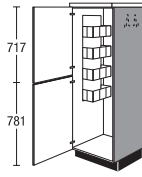

Equipment versions

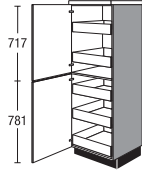
	<p>Clip hinge, standard version Version 414 in combination with a high-quality flap stay</p>
	<p>Cushioning for hinged doors Top Motion (surcharge) Version 418 Integrated door cushioning CLIP top BLUMOTION by Blum in combination with a high-quality flap stay</p>
	<p>Cushioning for hinged doors Top Motion (surcharge) Version 428 Integrated door cushioning CLIP top BLUMOTION by Blum in combination with AVENTOS HKS flap stay by Blum</p>

Highboards

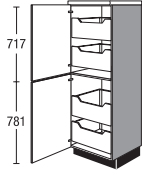
1507 mm high

Unit without worktop and plinth, carcass depth 560 mm. Order worktop separately.

				width	Price group							Servosoft	Pro Servosoft	ProServodglass	Soft closing Top Motion	Soft closing Top Motion Plus	
					1	2	3	4	5	6	7						
 <p>Highboard 1 hinged door 1 adjustable shelf 1 hinged door 1 adjustable shelf</p>		CS	30	151	V	122	131	137	146	162	179	201	-	-	-	8	8
		CS	45	151	V	131	139	147	156	174	191	214	-	-	-	8	8
		CS	50	151	V	136	146	154	163	181	200	224	-	-	-	8	8
		CS	60	151	V	142	152	160	170	189	208	233	-	-	-	8	8
 <p>Highboard 1 hinged door 2 adjustable shelves 1 hinged door <i>Width can be shortened down to 300 mm</i></p>		CS	60	151	VQ	142	152	160	170	189	208	233	-	-	-	10	10
 <p>Highboard for brooms 1 door (dowelled) 1 wire shelf 1 hook for brooms 1 universal holder for cable, hose and vacuum cleaner accessories stowage of vacuum cleaner, step ladder or ironing board possible <i>No wire parts if depth is reduced.</i></p>		CS	45	151	VB	154	163	171	179	196	211	233	-	-	-	8	8
		CS	50	151	VB	157	167	175	183	201	217	239	-	-	-	8	8
		CS	60	151	VB	167	177	186	194	213	230	253	-	-	-	8	8
 <p>Highboard 1 hinged door 2 internal drawers 1 hinged door 3 interior drawers <i>The hinged doors must open to an angle of at least 90°. Door must not be hinged on side adjacent to the worktop.</i></p>		CS	30	151	VIS	219	228	239	249	271	291	319	25	40	40	8	8
		CS	45	151	VIS	240	251	261	271	294	315	347	25	40	40	8	8
		CS	50	151	VIS	246	256	267	277	300	323	354	25	40	40	8	8
		CS	60	151	VIS	258	270	280	292	316	339	372	25	40	40	8	8
 <p>Highboard 1 hinged door 2 interior deep drawers 1 hinged door 2 interior deep drawers <i>The hinged doors must open to an angle of at least 90°. Door must not be hinged on side adjacent to the worktop.</i></p>		CS	30	151	VIA	214	224	238	252	264	284	312	20	32	64	8	8
		CS	45	151	VIA	232	248	261	276	306	337	375	20	32	64	8	8
		CS	50	151	VIA	237	252	267	281	313	344	384	20	32	64	8	8
		CS	60	151	VIA	250	266	281	297	329	362	404	20	32	64	8	8





Illustrations do not correspond to front finishes / Door buffer = flap door stay buffer

5.117

Highboards

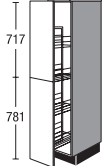
1507 mm high

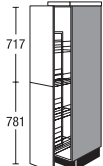
Unit without worktop and plinth, carcass depth 560 mm. Order worktop separately.

		width	Price group							Servosoft	Pro-Servosoft	ProServoGlass	Soft closing Top Motion	Soft closing Top Motion Plus			
			1	2	3	4	5	6	7								
 <p>Pull-out larder highboard with wire baskets, silver grey</p> <p>1 full-extension pull-out (dowelled) with cushioning 4 adjustable baskets</p>  <p>Baskets: clip-on baskets silver grey</p> <p>Suitable additions:</p> <p>Hanging basket silver-grey</p> <p>Insert tray plastic white 12 mm high</p>	CSA	30	151	V	257	270	272	275	280	291	309	36	36	36	-	-	
		ZIK	30			6	6	6	6	6	6	6	-	-	-	-	-
		ZIE	30			3	3	3	3	3	3	3	-	-	-	-	-
 <p>Pull-out larder highboard</p> <p>Baskets with wooden shelf and metal rail</p> <p>1 full-extension pull-out (dowelled) with cushioning 4 adjustable baskets</p>  <p>Baskets: wooden shelf and metal rail</p> <p><i>Runner profile top and bottom Baskets can be used from both sides.</i></p> <p>Suitable additions:</p> <p>Hanging basket Wooden shelf with metal rail</p>	CSA	30	151	VP	338	352	355	359	366	378	402	-	-	-	-	-	
		ZIK	30	P		7	7	7	7	7	7	7	-	-	-	-	-

Appliance housings with niche height 880 mm, Appliance housings with niche height 1025 mm

1507 mm high

Unit without worktop and plinth, carcass depth 560 mm. Order worktop separately.

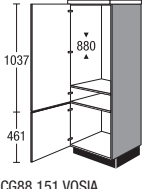
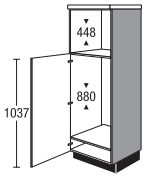
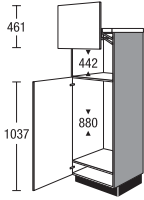
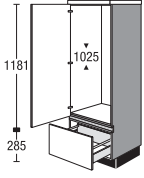
	width	Price group							Servosoft	Pro Servosoft	ProServoGlass	Soft closing Top Motion	Soft closing Top Motion Plus		
		1	2	3	4	5	6	7							
 <p>Highboard for built-in appliances Niche height 880 mm</p> <p>1 appliance door 1 fixed shelf 1 hinged door</p> <p><i>Ventilation grills for unit ventilation are included in the delivery.</i></p> <p>CG88 151 VQ5IA</p>	CG88	151	VQ	136	145	152	159	176	195	218	-	-	-	10	10
 <p>Highboard for built-in appliances niche height 448 mm Niche height 880 mm</p> <p>1 appliance door</p> <p><i>Niche size may be adjusted with internal infill panel or intermediate shelf</i></p> <p><i>Ventilation grills for unit ventilation are included in the delivery.</i></p> <p><i>One front panel per appliance type will be provided for adaptation on site.</i></p> <p><i>Cover strips for the microwave aperture (MZCVMW) are included for a charge and do not need to be factored into the order.</i></p> <p>CG88M 151 V5SOA</p>	CG88M	151	V5	130	141	150	158	179	198	222	-	-	-	6	6
 <p>Highboard for built-in appliances with lift-up door Recess height 442 mm Niche height 880 mm</p> <p>same as above, but plus 1 lift-up door</p> <p>Maximum size of stand-alone Height 400 mm Width 510 mm Depth: 540</p> <p>430 mm opening height for lift-up door</p> <p><i>To be able to open the lift-up door, the top panel must not overhang by more than 28 mm.</i></p> <p>CG88M 151 VL5FIA</p>	CG88M	151	VL5	197	214	228	241	271	300	337	-	-	-	6	6
 <p>Highboard for built-in appliances niche height 1025 mm</p> <p>1 hinged appliance door 1 deep drawer</p> <p><i>Ventilation grills for unit ventilation are included in the delivery.</i></p> <p>CG102A 151 HVSLC</p>	CG102A	151	HV	159	168	176	184	204	222	246	5	8	16	6	6

Illustrations do not correspond to front finishes / Door buffer = flap door stay buffer

5.119

Appliance housings with niche height 1025 mm, Appliance housings with niche height 1225 mm

1507 mm high

Unit without worktop and plinth, carcass depth 560 mm. Order worktop separately.

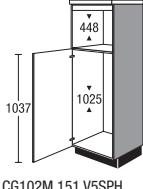
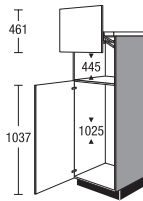
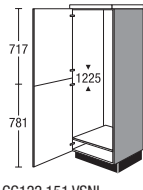
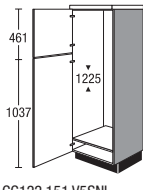
	width	Price group							Servosoft	Pro Servosoft	ProServoGlass	Soft closing Top Motion	Soft closing Top Motion Plus		
		1	2	3	4	5	6	7							
 <p>Highboard for built-in appliances niche height 448 mm niche height 1025 mm 1 appliance door</p> <p><i>One front panel per appliance type will be provided for adaptation on site.</i></p> <p><i>Niche size may be adjusted with internal infill panel or intermediate shelf</i></p> <p><i>Ventilation grills for unit ventilation are included in the delivery.</i></p> <p><i>Depending on type with metal plinth shelf.</i></p> <p><i>Cover strips for the microwave aperture (MZCVMW) are included for a charge and do not need to be factored into the order.</i></p> <p>CG102M 151 V5SPH</p>	CG102M	151	V5	161	173	181	190	210	229	255	-	-	-	6	6
 <p>Highboard for built-in appliances with lift-up door Recess height 445 mm niche height 1025 mm same as above, but plus 1 lift-up door</p> <p>Maximum size of stand-alone Height 400 mm Width 510 mm Depth: 540</p> <p>430 mm opening height for lift-up door</p> <p><i>To be able to open the lift-up door, the top panel must not overhang by more than 28 mm.</i></p> <p>CG102M 151 VL5FLC</p>	CG102M	151	VL5	228	245	257	270	298	325	362	-	-	-	6	6
 <p>Highboard for built-in appliances niche height 1225 mm 1 hinged appliance door (pinned) consisting of 2 fronts</p> <p><i>Niche size may be adjusted with internal infill panel or intermediate shelf</i></p> <p><i>Ventilation grills for unit ventilation are included in the delivery.</i></p> <p>CG122 151 VSNL</p>	CG122	151	V	142	152	160	169	189	208	232	-	-	-	8	8
 <p>Highboard for built-in appliances niche height 1225 mm 2 hinged appliance doors</p> <p><i>Niche size may be adjusted with internal infill panel or intermediate shelf</i></p> <p><i>Ventilation grills for unit ventilation are included in the delivery.</i></p> <p>CG122 151 V5SNI</p>	CG122	151	V5	132	142	150	158	178	196	219	-	-	-	10	10

5.120 Illustrations do not correspond to front finishes / Door buffer = flap door stay buffer

Appliance housings with niche height 1400 mm, Appliance housings with niche height 450 mm, Appliance housings with niche height 590 mm

1507 mm high

Unit without worktop and plinth, carcass depth 560 mm. Order worktop separately.

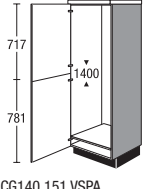
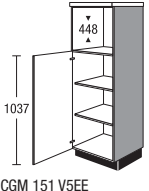
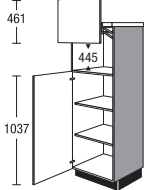
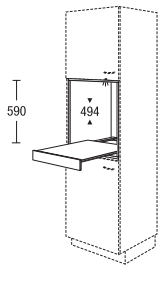
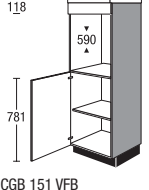
	width	Price group							Servosoft	Pro Servosoft	ProServoglass	Soft closing Top Motion	Soft closing Top Motion Plus		
		1	2	3	4	5	6	7							
 <p>Highboard for built-in appliances Niche height 1400 mm 1 hinged appliance door (pinned) <i>Niche size may be adjusted with internal infill panel or intermediate shelf</i> <i>Ventilation grills for unit ventilation are included in the delivery.</i></p> <p>CG140 151 VSPA</p>	CG140	151	V	142	152	160	169	189	208	232	-	-	-	8	8
 <p>Highboard for built-in appliances niche height 448 mm 1 hinged door 2 adjustable shelves <i>Niche size may be adjusted with internal infill panel or intermediate shelf</i></p> <p>CGM 151 V5EE</p>	CGM	151	V5	132	141	150	158	179	198	222	-	-	-	6	6
 <p>Highboard for built-in appliances with lift-up door Recess height 445 mm same as above, but plus 1 lift-up door Maximum size of stand-alone Height 390 mm Width 510 mm Depth: 540 430 mm opening height for lift-up door <i>To be able to open the lift-up door, the top panel must not overhang by more than 28 mm.</i></p> <p>CGM 151 VL5</p>	CGM	151	VL5	199	213	227	239	270	299	335	-	-	-	6	6
 <p>Modular built in shelf unit for highboard / tall unit for niche heights 590 mm Depth: 505 mm 1 pull-out shelf <i>Finish in carcass material</i> <i>Not available in visible side colours.</i></p> <p>MR</p>	MR	60	59	TA	201	201	201	201	201	201	-	-	-	-	-
 <p>Highboard for built-in appliances niche height 590 mm 1 fixed front panel 1 hinged door 1 adjustable shelf <i>For foil-wrapped fronts a set of heat deflector plates are supplied free of charge.</i> <i>Cover strips for the oven aperture (MZCVBO) are included for a charge and do not need to be factored into the order.</i></p> <p>CGB 151 VFB</p>	CGB	151	V	137	146	154	162	181	200	223	-	-	-	4	4

Illustrations do not correspond to front finishes / Door buffer = flap door stay buffer

5.121

Appliance housings with niche height 590 mm, Shelf units, Fillers

1507 mm high

Unit without worktop and plinth, carcass depth 560 mm. Order worktop separately.

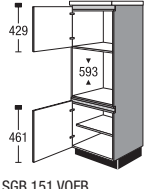
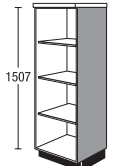
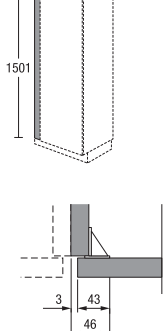
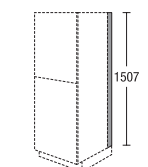
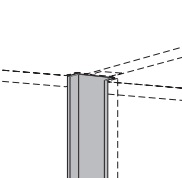
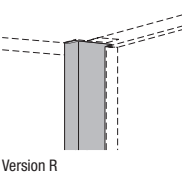
		width	Price group							Servosoft	Pro Servosoft	ProServoGlass	Soft closing Top Motion	Soft closing Top Motion Plus
			1	2	3	4	5	6	7					
 <p>Highboard for built-in appliances Niche height 593 mm 1 hinged door 1 hinged door</p> <p><i>For foil-wrapped fronts a set of heat deflector plates are supplied free of charge.</i></p> <p><i>Cover strips for the oven aperture (MZCVBO) are included for a charge and do not need to be factored into the order.</i></p>	CGB	151 VQ	137	146	154	162	181	200	223	-	-	-	8	8
 <p>Highboard shelf unit 3 adjustable shelves</p> <p><i>Finish in carcass material</i></p> <p><i>Please indicate desired width (150-600 mm).</i></p> <p><i>Not available in visible side colours.</i></p>	☑ CSR	V 151	203	203	203	203	203	203	203	-	-	-	-	-
 <p>Infill panel for highboard without plinth, 1507 mm high Fitted between wall and carcass side</p> <p><i>Finish in continuous door material without edging on the wall side</i></p> <p><i>Not available in visible side colours.</i></p> <p><i>Due to the installation angle, the maximum possible on-site width reduction is 46 mm.</i></p>	CSPF CSPF	10 151 E 20 151 E	28 35	32 38	33 40	34 42	36 49	39 54	43 60	-	-	-	-	-
 <p>Infill panel for highboard side without plinth, 1507 mm high 16 mm deep for wall end</p> <p><i>Finish laminate, stainless steel look</i></p> <p><i>for deeper tops, order plinth SO 151 separately</i></p>	CDTS	151	10	10	10	10	10	10	10	-	-	-	-	-
 <p>Recessed grip For planning between units</p>	CVC	151	30	30	30	30	30	30	30	-	-	-	-	-
 <p>Recessed grip For planning individual highboards or alongside a panel</p> <p>Version R</p>	CVL CVL	151 L 151 R	28 28	28 28	28 28	28 28	28 28	28 28	28 28	-	-	-	-	-

Tall units

1971 mm high

Unit without plinth, carcass depth 560 mm

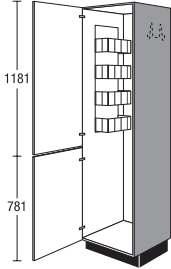
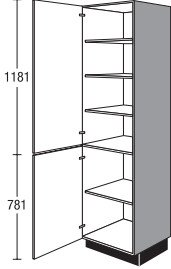
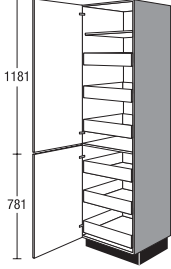
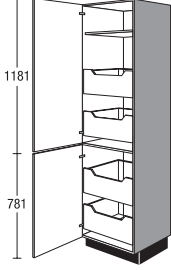
				width	Price group							Servosoft	Pro Servosoft	ProServoglass	Soft closing Top Motion	Soft closing Top Motion Plus	
					1	2	3	4	5	6	7						
 <p>Tall broom cupboard 1 door (dowelled) 1 wire shelf 1 hook for brooms 1 universal holder for cable, hose and vacuum cleaner accessories stowage of vacuum cleaner, step ladder or ironing board possible <i>No wire parts if depth is reduced.</i></p>		CS	45	01	VB	166	176	185	193	212	228	252	-	-	-	10	10
	☑	CS	50	01	VB	174	185	194	202	222	239	264	-	-	-	10	10
		CS	60	01	VB	178	189	198	207	227	245	270	-	-	-	10	10
 <p>Tall unit 1 hinged door 3 adjustable shelves 1 hinged door 1 adjustable shelf</p>	☑	CS	30	01	V	131	137	144	152	166	180	199	-	-	-	10	10
	☑	CS	45	01	V	153	160	169	177	194	210	232	-	-	-	10	10
	☑	CS	50	01	V	160	169	178	186	204	221	244	-	-	-	10	10
	☑	CS	60	01	V	163	172	180	189	207	225	249	-	-	-	10	10
 <p>Tall unit 1 hinged door 1 fixed shelf 3 interior drawers 1 hinged door 3 interior drawers <i>The hinged doors must open to an angle of at least 90°. Door must not be hinged on side adjacent to the worktop.</i></p>	☑	CS	30	01	VIS	254	273	286	300	324	345	374	30	48	48	10	10
	☑	CS	45	01	VIS	277	296	311	325	351	373	404	30	48	48	10	10
	☑	CS	50	01	VIS	285	304	320	335	362	386	417	30	48	48	10	10
	☑	CS	60	01	VIS	302	322	338	355	383	407	440	30	48	48	10	10
 <p>Tall unit 1 hinged door 1 fixed shelf 2 interior deep drawers 1 hinged door 2 interior deep drawers <i>The hinged doors must open to an angle of at least 90°. Door must not be hinged on side adjacent to the worktop.</i></p>	☑	CS	30	01	VIA	228	245	258	272	304	333	370	20	32	64	10	10
	☑	CS	45	01	VIA	252	267	279	293	324	352	390	20	32	64	10	10
	☑	CS	50	01	VIA	263	276	291	304	333	361	399	20	32	64	10	10
	☑	CS	60	01	VIA	272	285	300	312	342	369	407	20	32	64	10	10



Illustrations do not correspond to front finishes / Door buffer = flap door stay buffer

5.123

Tall units

1971 mm high

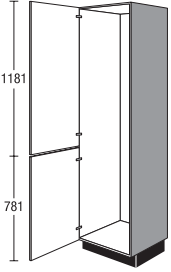
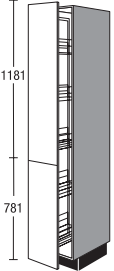

Unit without plinth, carcass depth 560 mm

		width	Price group							Servosoft	Pro Servosoft	ProServoGlass	Soft closing Top Motion	Soft closing Top Motion Plus		
			1	2	3	4	5	6	7							
 <p>Tall unit for individual equipping 1 hinged door (dowelled)</p>	CS	60	01	VZ	163	174	182	191	210	228	252	-	-	-	10	10
 <p>Pull-out tall unit with wire baskets, silver grey 1 full-extension pull-out with cushioning consisting of 2 fronts 5 adjustable baskets</p>	CSA	30	01	V	283	294	294	296	306	308	323	36	36	36	-	-
 <p>Baskets: clip-on baskets silver grey</p> <p>Suitable additions:</p>																
<p>Hanging basket silver-grey</p>	ZIK	30			6	6	6	6	6	6	6	-	-	-	-	-
<p>Insert tray plastic white 12 mm high</p>	ZIE	30			3	3	3	3	3	3	3	-	-	-	-	-

Tall units

1971 mm high

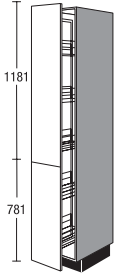
Unit without plinth, carcass depth 560 mm

				Price group												
				width	1	2	3	4	5	6	7	Servosoft	Pro Servosoft	ProServoglass	Soft closing Top Motion	Soft closing Top Motion Plus
 <p>Pull-out tall unit Baskets with wooden shelf and metal rail 1 full-extension pull-out with cushioning consisting of 2 fronts 5 adjustable baskets <i>Runner profile top and bottom Baskets can be used from both sides.</i></p>  <p>Baskets: wooden shelf and metal rail</p> <p>Suitable additions:</p> <p>Hanging basket Wooden shelf with metal rail</p>	CSA	30	01	VP	368	379	380	382	394	396	414	-	-	-	-	-
	ZIK	30		P	7	7	7	7	7	7	7	-	-	-	-	-

Illustrations do not correspond to front finishes / Door buffer = flap door stay buffer

5.125

Appliance housings with niche height 880 mm, Appliance housings with niche height 1025 mm

1971 mm high

Unit without plinth, carcass depth 560 mm

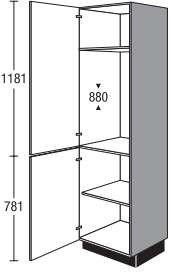
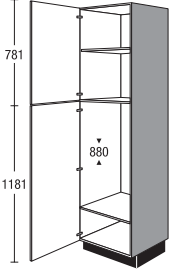
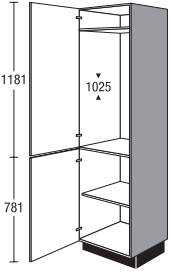
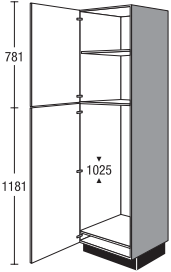
	CG	width		Price group							Servosoft	Pro Servosoft	ProServoGlass	Soft closing Top Motion	Soft closing Top Motion Plus
				1	2	3	4	5	6	7					
 <p>Tall unit for appliances Niche height 880 mm</p> <p>1 hinged appliance door 1 fixed shelf 1 hinged door 1 adjustable shelf</p> <p><i>For cladding up to the ceiling, provision must be made for a ventilation opening of min. 200 cm² in diameter.</i></p> <p>CG88 01 VSIA</p>	CG88	01	V	157	168	179	190	217	241	272	-	-	-	10	10
 <p>Tall unit for appliances Niche height 880 mm</p> <p>1 hinged door 1 adjustable shelf 1 hinged appliance door 1 fixed shelf</p> <p><i>For cladding up to the ceiling, provision must be made for a ventilation opening of min. 200 cm² in diameter.</i></p> <p>CG88 01 V8SIA</p>	CG88	01	V8	157	168	179	190	217	241	272	-	-	-	10	10
 <p>Tall unit for appliances niche height 1025 mm</p> <p>1 hinged appliance door 1 fixed shelf 1 hinged door 1 adjustable shelf</p> <p><i>For cladding up to the ceiling, provision must be made for a ventilation opening of min. 200 cm² in diameter.</i></p> <p>CG102 01 VSLC</p>	CG102	01	V	157	168	179	190	217	241	272	-	-	-	10	10
 <p>Tall unit for appliances niche height 1025 mm</p> <p>1 hinged door 1 adjustable shelf 1 hinged appliance door 1 fixed shelf</p> <p><i>For cladding up to the ceiling, provision must be made for a ventilation opening of min. 200 cm² in diameter.</i></p> <p>CG102 01 V8SLC</p>	CG102	01	V8	157	168	179	190	217	241	272	-	-	-	10	10

5.126

Illustrations do not correspond to front finishes / Door buffer = flap door stay buffer

Appliance housings with niche height 1025 mm, Appliance housings with niche height 1225 mm

1971 mm high

Unit without plinth, carcass depth 560 mm

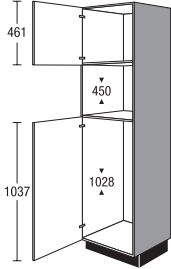
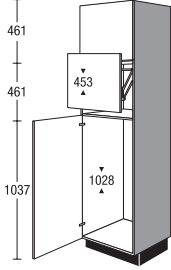
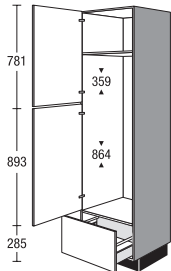
		Price group													
		width	1	2	3	4	5	6	7	Servosoft	Pro Servosoft	ProServoglass	Soft closing Top Motion	Soft closing Top Motion Plus	
 <p>Tall unit for appliances Niche height 450 mm Recess height 1028 mm 1 hinged door 1 appliance door 1 metal plinth base</p> <p><i>One front panel per appliance type will be provided for adaptation on site.</i></p> <p><i>Version supplied may deviate from the illustration according to appliance type.</i></p> <p><i>Cover strips for the microwave aperture (MZCVMW) are included for a charge and do not need to be factored into the order.</i></p> <p><i>For cladding up to the ceiling, provision must be made for a ventilation opening of min. 200 cm² in diameter.</i></p> <p>CG102M 01 V5SPH</p>	CG102M	01	V5	184	197	208	223	235	256	281	-	-	-	10	10
	 <p>Tall unit for appliances with lift-up door Recess height 453 mm Recess height 1028 mm same as above, but plus 1 lift-up door</p> <p>Maximum size of stand-alone Height 400 mm Width 510 mm Depth: 540</p> <p>430 mm opening height for lift-up door</p> <p>CG102M 01 VL5FLC</p>	CG102M	01	VL5	252	269	284	304	321	349	384	-	-	-	10
 <p>Tall unit for appliances Recess height 359 mm Recess height 864 mm 2 hinged appliance doors 1 fixed shelf 1 deep drawer</p> <p>niche size adjustment partially with infill panels.</p> <p><i>For cladding up to the ceiling, provision must be made for a ventilation opening of min. 200 cm² in diameter.</i></p> <p>CG122A 01 VSNI</p>	CG122A	01	V	215	229	242	254	283	300	326	5	8	16	8	8

Illustrations do not correspond to front finishes / Door buffer = flap door stay buffer

5.127

Appliance housings with niche height 1400 mm, Appliance housings with niche height 1445 mm, Appliance housings with niche height 1580 mm

1971 mm high

Unit without plinth, carcass depth 560 mm

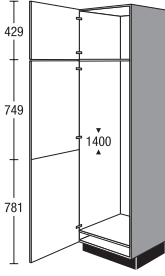
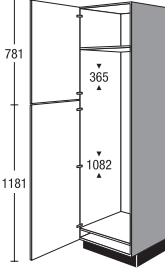
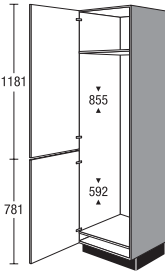
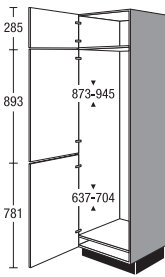
	CG	width		Price group							Servosoft	Pro Servosoft	ProServoGlass	Soft closing Top Motion	Soft closing Top Motion Plus
				1	2	3	4	5	6	7					
 <p>Tall unit for appliances Niche height 1400 mm</p> <p>1 hinged door 1 hinged appliance door (pinned)</p> <p><i>niche size adjustment partially with infill panels.</i></p> <p><i>Version supplied may deviate from the illustration according to appliance type.</i></p> <p><i>For cladding up to the ceiling, provision must be made for a ventilation opening of min. 200 cm² in diameter.</i></p> <p>CG140 01 VSPA</p>	CG140	01	V	183	196	210	225	257	279	307	-	-	-	12	12
 <p>Tall unit for appliances Recess height 365 mm Recess height 1082 mm</p> <p>1 appliance door 1 fixed shelf 1 appliance door</p> <p><i>niche size adjustment partially with infill panels.</i></p> <p><i>Version supplied may deviate from the illustration according to appliance type.</i></p> <p><i>For cladding up to the ceiling, provision must be made for a ventilation opening of min. 200 cm² in diameter.</i></p> <p>CG145 01 V8SPK</p>	CG145	01	V8	162	174	186	200	228	247	272	-	-	-	10	10
 <p>Tall unit for appliances Recess height 855 mm Niche height 592 mm</p> <p>1 appliance door 1 fixed shelf 1 appliance door</p> <p><i>niche size adjustment partially with infill panels.</i></p> <p><i>Version supplied may deviate from the illustration according to appliance type.</i></p> <p><i>For cladding up to the ceiling, provision must be made for a ventilation opening of min. 200 cm² in diameter.</i></p> <p>CG145 01 VSPE</p>	CG145	01	V	162	174	186	200	228	247	272	-	-	-	10	10
 <p>Tall unit for appliances Recess height 873 - 945 mm Recess height 637 - 704 mm</p> <p>1 hinged door 2 hinged appliance doors</p> <p><i>niche size adjustment partially with infill panels.</i></p> <p><i>Version supplied may deviate from the illustration according to appliance type.</i></p> <p><i>For cladding up to the ceiling, provision must be made for a ventilation opening of min. 200 cm² in diameter.</i></p> <p>CG158 01 VSRL</p>	CG158	01	V	161	176	183	193	219	244	263	-	-	-	12	12

5.128

Illustrations do not correspond to front finishes / Door buffer = flap door stay buffer

Appliance housings with niche height 1780 mm, Appliance housings with aperture height 1890 mm, Appliance housings with niche height 450 mm

1971 mm high

Unit without plinth, carcass depth 560 mm

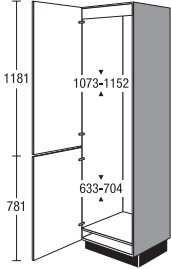
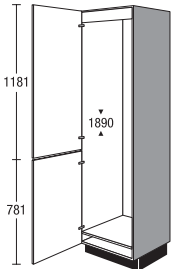
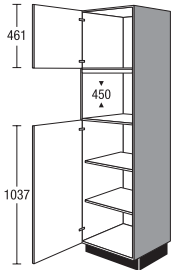
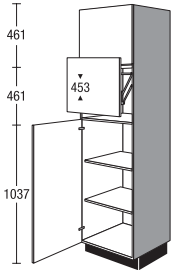
		width	Price group							Servosoft	Pro Servosoft	ProServoglass	Soft closing Top Motion	Soft closing Top Motion Plus	
			1	2	3	4	5	6	7						
 <p>Tall unit for appliances Recess height 1073 - 1152 mm Recess height 633 - 704 mm 2 hinged appliance doors for opening together or separately, according to finish and type of appliance <i>niche size adjustment partially with infill panels.</i> <i>Version supplied may deviate from the illustration according to appliance type.</i> For cladding up to the ceiling, provision must be made for a ventilation opening of min. 200 cm² in diameter.</p> <p>CG178 01 VSTD</p>	CG178	01	V	161	176	183	193	219	244	274	-	-	-	10	10
 <p>Tall unit for appliances Recess height 1890 mm 2 hinged appliance doors For cladding up to the ceiling, provision must be made for a ventilation opening of min. 200 cm² in diameter.</p> <p>CG189 01 VSUH</p>	CG189	01	V	161	176	183	193	219	244	274	-	-	-	10	10
 <p>Tall unit for appliances Niche height 450 mm 1 hinged door 1 hinged door 2 adjustable shelves One front panel per appliance type will be provided for adaptation on site. Cover strips for the microwave aperture (MZCVMW) are included for a charge and do not need to be factored into the order. Recess sizes are adjusted in part through the use of carcass panels.</p> <p>CGM 01 V5EE</p>	CGM	01	V5	168	180	192	206	219	240	264	-	-	-	10	10
 <p>Tall unit for appliances with lift-up door Recess height 453 mm same as above, but plus 1 lift-up door Maximum size of stand-alone Height 400 mm Width 510 mm Depth: 540 430 mm opening height for lift-up door</p> <p>CGM 01 VL5</p>	CGM	01	VL5	235	252	269	289	306	336	370	-	-	-	10	10

Illustrations do not correspond to front finishes / Door buffer = flap door stay buffer

5.129

Appliance housings with niche height 450 mm, Appliance housings with niche height 590 mm

1971 mm high

Unit without plinth, carcass depth 560 mm

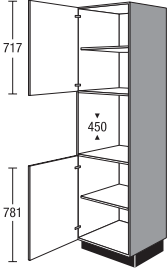
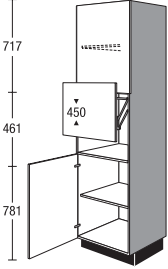
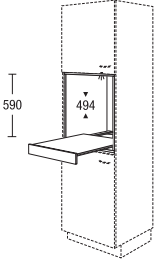
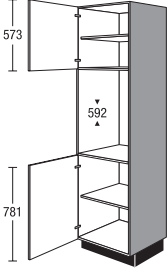
		width	Price group							Servosoft	Pro Servosoft	ProServoGlass	Soft closing Top Motion	Soft closing Top Motion Plus	
			1	2	3	4	5	6	7						
 <p>Tall unit for appliances Niche height 450 mm</p> <p>1 hinged door 1 adjustable shelf (depending on finish) 1 hinged door 1 adjustable shelf</p> <p><i>Cover strips for the microwave aperture (MZCVMW) are included for a charge and do not need to be factored into the order.</i></p> <p>CGM 01 VEE</p>	CGM	01	V	162	172	180	190	205	216	230	-	-	-	8	8
 <p>Tall unit for appliances with lift-up door Niche height 450 mm</p> <p>same as above, but plus 1 lift-up door</p> <p>Maximum size of stand-alone Height 400 mm Width 510 mm Depth: 540</p> <p>430 mm opening height for lift-up door</p> <p>CGM 01 VL</p>	CGM	01	VL	229	243	255	269	291	305	325	-	-	-	8	8
 <p>Modular built in shelf unit for highboard / tall unit</p> <p>for niche heights 590 mm Depth: 505 mm</p> <p>1 pull-out shelf</p> <p><i>Finish in carcass material</i></p> <p><i>Not available in visible side colours.</i></p> <p>MR</p>	MR	60	59	TA	201	201	201	201	201	201	201	-	-	-	-
 <p>Tall unit for appliances Niche height 592 mm</p> <p>1 hinged door 1 adjustable shelf 1 hinged door 1 adjustable shelf</p> <p><i>For foil-wrapped fronts a set of heat deflector plates are supplied free of charge.</i></p> <p><i>Cover strips for the oven aperture (MZCVB0) are included for a charge and do not need to be factored into the order.</i></p> <p>CGB 01 VFB</p>	CGB	01	V	165	173	180	188	202	210	223	-	-	-	8	8

5.130 Illustrations do not correspond to front finishes / Door buffer = flap door stay buffer

Appliance housings with niche height 590 mm

1971 mm high

Unit without plinth, carcass depth 560 mm

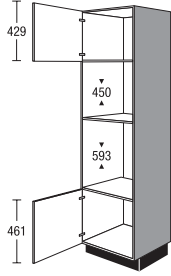
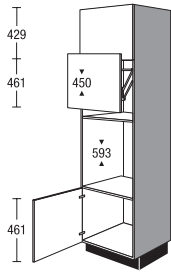
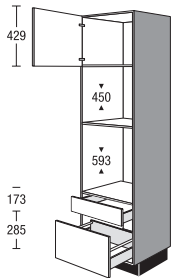
		width	Price group							Servosoft	Pro Servosoft	ProServoglass	Soft closing Top Motion	Soft closing Top Motion Plus	
			1	2	3	4	5	6	7						
 <p>Tall unit for appliances Niche height 450 mm Niche height 593 mm</p> <p>1 hinged door 1 hinged door</p> <p><i>For foil-wrapped fronts a set of heat deflector plates are supplied free of charge.</i></p> <p><i>Cover strips for the microwave aperture (MZCVMW) as well as for the oven aperture (MZCVBO) are included for a charge and do not need to be factored into the order.</i></p> <p>CGMB 01 VQLD</p>	CGMB	01	VQ	153	170	178	185	194	212	232	-	-	-	8	8
	 <p>Tall unit for appliances with lift-up door Niche height 450 mm Niche height 593 mm</p> <p>same as above, but plus 1 lift-up door</p> <p>Maximum size of stand-alone Height 400 mm Width 510 mm Depth: 540</p> <p>430 mm opening height for lift-up door</p> <p><i>Cover strips for the oven aperture (MZCVBO) are included for a charge and do not need to be factored into the order.</i></p> <p>CGMB 01 VLQFB</p>	CGMB	01	VLQ	220	245	255	267	279	305	335	-	-	-	8
 <p>Tall unit for appliances Niche height 450 mm Niche height 593 mm</p> <p>1 hinged door 1 drawer 1 deep drawer</p> <p><i>For foil-wrapped fronts a set of heat deflector plates are supplied free of charge.</i></p> <p><i>Cover strips for the microwave aperture (MZCVMW) as well as for the oven aperture (MZCVBO) are included for a charge and do not need to be factored into the order.</i></p> <p>CGMBSA 01 VQLD</p>		CGMBSA	01	VQ	196	218	228	238	249	273	298	10	16	24	4

Illustrations do not correspond to front finishes / Door buffer = flap door stay buffer

5.131

Appliance housings with niche height 590 mm, Shelf units, Fillers

1971 mm high

Unit without plinth, carcass depth 560 mm

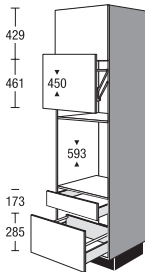
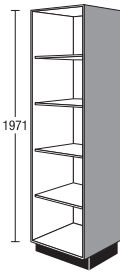
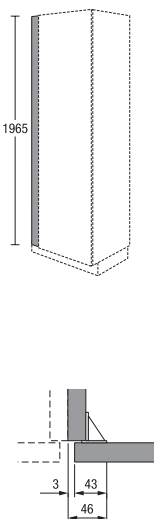
	width	Price group							Servosoft	Pro Servosoft	ProServoGlass	Soft closing Top Motion	Soft closing Top Motion Plus			
		1	2	3	4	5	6	7								
 <p>Tall unit for appliances with lift-up door Niche height 450 mm Niche height 593 mm same as above, but plus 1 lift-up door</p> <p>Maximum size of stand-alone Height 400 mm Width 510 mm Depth: 540</p> <p>430 mm opening height for lift-up door</p> <p><i>Cover strips for the oven aperture (MZCVB0) are included for a charge and do not need to be factored into the order.</i></p> <p>CGMBSA 01 VLQFB</p>	CGMBSA	01	VLQ	263	293	305	320	334	366	399	10	16	24	4	4	
 <p>Tall shelf unit</p> <p>4 adjustable shelves</p> <p><i>Finish in carcass material</i></p> <p><i>Please indicate desired width (150-600 mm).</i></p> <p><i>Not available in visible side colours.</i></p>	CSR	V	01	227	227	227	227	227	227	227	-	-	-	-	-	
 <p>Infill panel for tall unit</p> <p>without plinth, 1971 mm high Fitted between wall and carcass side</p> <p><i>Finish in continuous door material without edging on the wall side</i></p> <p><i>Not available in visible side colours.</i></p> <p><i>Due to the installation angle, the maximum possible on-site width reduction is 46 mm.</i></p> <p><i>Available for the following fronts:</i> IP 2200, Vintage oak effect no. 138 IP 2200, Light oak effect no. 141 IP 2200, Oregon oak effect no. 142 IP 2200, Oak effect black no. 143 IP 2200, Summerfield oak effect no. 163</p>	CSPF CSPF	10 20	01 01	E E	29 37	33 40	34 42	35 45	37 52	40 57	45 63	-	-	-	-	-

5.132 Illustrations do not correspond to front finishes / Door buffer = flap door stay buffer

Fillers

1971 mm high

with neutral door division

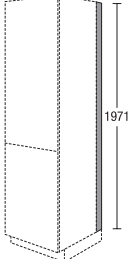
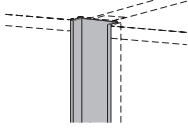
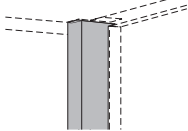
		width	Price group							Servosoft	Pro Servosoft	ProServoglass	Soft closing Top Motion	Soft closing Top Motion Plus
			1	2	3	4	5	6	7					
 <p>Infill panel for tall-unit side without plinth, 1971 mm high 16 mm deep for wall end</p> <p><i>Finish laminate, stainless steel look</i> <i>for deeper tops, order plinth SO 151 separately</i></p>	CDTS	01	11	11	11	11	11	11	11	-	-	-	-	-
 <p>Recessed grip For planning between units</p>	CVC	01	36	36	36	36	36	36	36	-	-	-	-	-
 <p>Recessed grip For planning individual tall units or alongside a panel</p> <p>Version R</p>	CVL CVL	01 L 01 R	32 32	32 32	32 32	32 32	32 32	32 32	32 32	- -	- -	- -	- -	- -

Illustrations do not correspond to front finishes / Door buffer = flap door stay buffer

5.133

Tall units

2115 mm high

Unit without plinth, carcass depth 560 mm

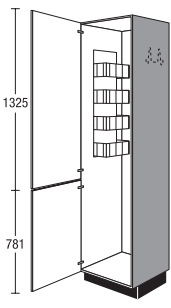
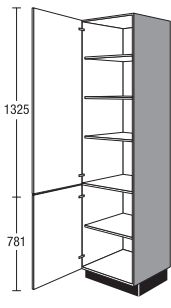
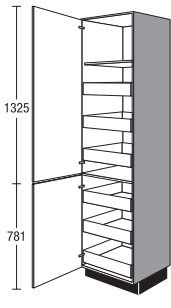
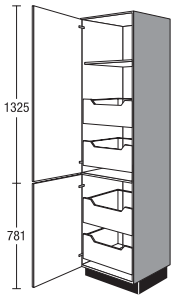

				width	Price group												
					1	2	3	4	5	6	7	ServoSoft	Pro ServoSoft	ProServoGlass	Soft closing Top Motion	Soft closing Top Motion Plus	
 <p>Tall broom cupboard</p> <ul style="list-style-type: none"> 1 door (dowelled) 1 wire shelf 1 hook for brooms 1 universal holder for cable, hose and vacuum cleaner accessories stowage of vacuum cleaner, step ladder or ironing board possible <p><i>No wire parts if depth is reduced.</i></p>	<input checked="" type="checkbox"/>	CS	45	02	VB	182	195	204	215	238	258	285	-	-	-	10	10
	<input checked="" type="checkbox"/>	CS	50	02	VB	186	199	209	220	244	264	291	-	-	-	10	10
	<input checked="" type="checkbox"/>	CS	60	02	VB	187	200	210	221	245	265	293	-	-	-	10	10
 <p>Tall unit</p> <ul style="list-style-type: none"> 1 hinged door 3 adjustable shelves 1 hinged door 1 adjustable shelf 	<input checked="" type="checkbox"/>	CS	30	02	V	136	146	153	161	179	193	213	-	-	-	10	10
	<input checked="" type="checkbox"/>	CS	45	02	V	165	177	185	196	216	234	258	-	-	-	10	10
	<input checked="" type="checkbox"/>	CS	50	02	V	170	181	191	202	222	241	266	-	-	-	10	10
	<input checked="" type="checkbox"/>	CS	60	02	V	172	183	193	204	225	244	269	-	-	-	10	10
 <p>Tall unit</p> <ul style="list-style-type: none"> 1 hinged door 1 fixed shelf 3 interior drawers 1 hinged door 3 interior drawers <p><i>The hinged doors must open to an angle of at least 90°.</i> <i>Door must not be hinged on side adjacent to the worktop.</i></p>	<input checked="" type="checkbox"/>	CS	30	02	VIS	271	291	304	318	349	373	405	30	48	48	10	10
	<input checked="" type="checkbox"/>	CS	45	02	VIS	293	315	331	348	379	405	436	30	48	48	10	10
	<input checked="" type="checkbox"/>	CS	50	02	VIS	301	324	341	358	391	418	448	30	48	48	10	10
	<input checked="" type="checkbox"/>	CS	60	02	VIS	311	334	351	370	403	431	463	30	48	48	10	10
 <p>Tall unit</p> <ul style="list-style-type: none"> 1 hinged door 1 fixed shelf 2 interior deep drawers 1 hinged door 2 interior deep drawers <p><i>The hinged doors must open to an angle of at least 90°.</i> <i>Door must not be hinged on side adjacent to the worktop.</i></p>	<input checked="" type="checkbox"/>	CS	30	02	VIA	242	257	269	281	312	336	371	20	32	64	10	10
	<input checked="" type="checkbox"/>	CS	45	02	VIA	266	282	296	310	340	367	403	20	32	64	10	10
	<input checked="" type="checkbox"/>	CS	50	02	VIA	270	287	300	315	345	372	409	20	32	64	10	10
	<input checked="" type="checkbox"/>	CS	60	02	VIA	281	299	313	328	360	388	426	20	32	64	10	10

5.134 Illustrations do not correspond to front finishes / Door buffer = flap door stay buffer

Tall units

2115 mm high

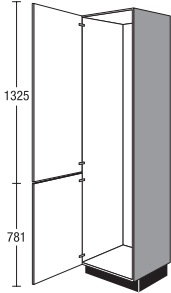
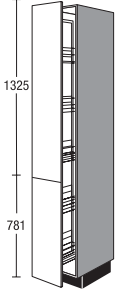
Unit without plinth, carcass depth 560 mm

		width	Price group							Servosoft	Pro Servosoft	ProServoglass	Soft closing Top Motion	Soft closing Top Motion Plus			
			1	2	3	4	5	6	7								
 <p>Tall unit for individual equipping 1 hinged door (dowelled)</p>	CS	60	02	VZ	172	184	194	204	228	247	274	-	-	-	10	10	
	 <p>Pull-out tall unit with wire baskets, silver grey 1 full-extension pull-out with cushioning consisting of 2 fronts 5 adjustable baskets</p>																
 <p>Baskets: clip-on baskets silver grey</p>																	
<p>Suitable additions:</p>																	
<p>Hanging basket silver-grey</p>		ZIK	30			6	6	6	6	6	6	6	-	-	-	-	-
<p>Insert tray plastic white 12 mm high</p>		ZIE	30			3	3	3	3	3	3	3	-	-	-	-	-



Illustrations do not correspond to front finishes / Door buffer = flap door stay buffer

5.135

Tall units

2115 mm high

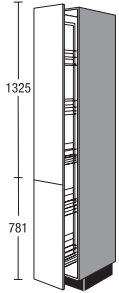
Unit without plinth, carcass depth 560 mm

	CSA	width	02	VP	Price group							Servosoft	Pro Servosoft	ProServoGlass	Soft closing Top Motion	Soft closing Top Motion Plus
					1	2	3	4	5	6	7					
 <p>Pull-out tall unit Baskets with wooden shelf and metal rail 1 full-extension pull-out with cushioning consisting of 2 fronts 5 adjustable baskets <i>Runner profile top and bottom Baskets can be used from both sides.</i></p>  <p>Baskets: wooden shelf and metal rail</p> <p>Suitable additions:</p> <p>Hanging basket Wooden shelf with metal rail</p>	CSA	30	02	VP	374	389	391	394	407	413	434	-	-	-	-	-
	ZIK	30		P	7	7	7	7	7	7	7	-	-	-	-	-

5.136 Illustrations do not correspond to front finishes / Door buffer = flap door stay buffer

Appliance housings with niche height 880 mm, Appliance housings with niche height 1025 mm

2115 mm high

Unit without plinth, carcass depth 560 mm

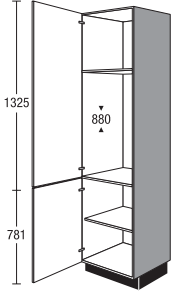
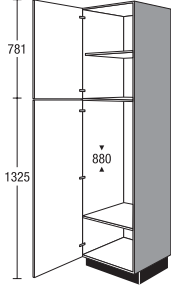
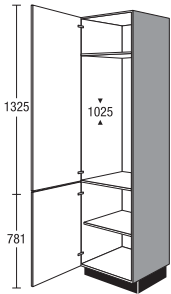
		width	Price group							Servosoft	Pro Servosoft	ProServoglass	Soft closing Top Motion	Soft closing Top Motion Plus	
			1	2	3	4	5	6	7						
 <p>Tall unit for appliances Niche height 880 mm</p> <ul style="list-style-type: none"> 1 hinged appliance door 1 fixed shelf 1 hinged door 1 adjustable shelf <p><i>For cladding up to the ceiling, provision must be made for a ventilation opening of min. 200 cm² in diameter.</i></p> <p>CG88 02 VSIA</p>	CG88	02	V	165	177	189	203	233	253	292	-	-	-	10	10
	 <p>Tall unit for appliances Niche height 880 mm</p> <ul style="list-style-type: none"> 1 hinged door 1 adjustable shelf 1 hinged appliance door 1 fixed shelf <p><i>For cladding up to the ceiling, provision must be made for a ventilation opening of min. 200 cm² in diameter.</i></p> <p>CG88 02 V9SIA</p>	CG88	02	V9	165	177	189	203	233	253	292	-	-	-	10
 <p>Tall unit for appliances niche height 1025 mm</p> <ul style="list-style-type: none"> 1 hinged appliance door 1 fixed shelf 1 hinged door 1 adjustable shelf <p><i>For cladding up to the ceiling, provision must be made for a ventilation opening of min. 200 cm² in diameter.</i></p> <p>CG102 02 VSLC</p>		CG102	02	V	165	177	189	203	233	253	292	-	-	-	10

Illustrations do not correspond to front finishes / Door buffer = flap door stay buffer

5.137

Appliance housings with niche height 1025 mm

2115 mm high

Unit without plinth, carcass depth 560 mm

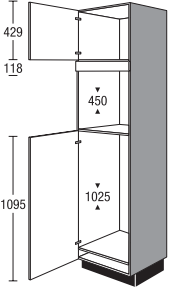
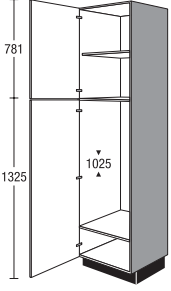
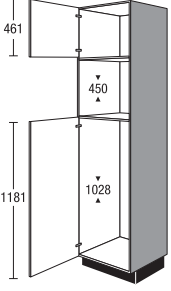
	width	Price group							Servosoft	Pro Servosoft	ProServoGlass	Soft closing Top Motion	Soft closing Top Motion Plus		
		1	2	3	4	5	6	7							
 <p>Tall unit for appliances Niche height 450 mm niche height 1025 mm</p> <p>1 hinged door 1 fixed front panel 1 appliance door</p> <p><i>One front panel per appliance type will be provided for adaptation on site.</i></p> <p><i>Version supplied may deviate from the illustration according to appliance type.</i></p> <p><i>For cladding up to the ceiling, provision must be made for a ventilation opening of min. 200 cm² in diameter.</i></p> <p><i>Cover strips for the microwave aperture (MZCVMW) are included for a charge and do not need to be factored into the order.</i></p> <p>CG102M 02 V6SPH</p>	CG102M	02	V6	192	204	216	228	242	262	286	-	-	-	10	10
 <p>Tall unit for appliances niche height 1025 mm</p> <p>1 hinged door 1 adjustable shelf 1 hinged appliance door 1 fixed shelf</p> <p><i>For cladding up to the ceiling, provision must be made for a ventilation opening of min. 200 cm² in diameter.</i></p> <p>CG102 02 V9SLC</p>	CG102	02	V9	165	177	189	203	233	253	292	-	-	-	10	10
 <p>Tall unit for appliances Niche height 450 mm Recess height 1028 mm</p> <p>1 hinged door 1 appliance door</p> <p><i>One front panel per appliance type will be provided for adaptation on site.</i></p> <p><i>Cover strips for the microwave aperture (MZCVMW) are included for a charge and do not need to be factored into the order.</i></p> <p><i>Version supplied may deviate from the illustration according to appliance type.</i></p> <p><i>For cladding up to the ceiling, provision must be made for a ventilation opening of min. 200 cm² in diameter.</i></p> <p>CG102M 02 V8SPH</p>	CG102M	02	V8	186	198	209	221	234	254	277	-	-	-	10	10

5.138 Illustrations do not correspond to front finishes / Door buffer = flap door stay buffer

Appliance housings with niche height 1025 mm, Appliance housings with niche height 1225 mm

2115 mm high

Unit without plinth, carcass depth 560 mm

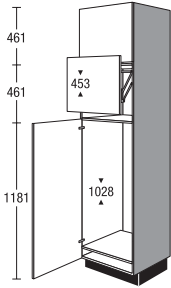
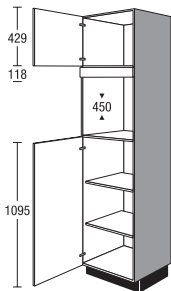
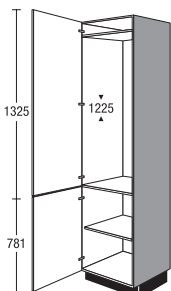
		width	Price group							Servosoft	Pro Servosoft	ProServoglass	Soft closing Top Motion	Soft closing Top Motion Plus	
			1	2	3	4	5	6	7						
 <p>Tall unit for appliances with lift-up door Recess height 453 mm Recess height 1028 mm same as above, but plus 1 lift-up door Maximum size of stand-alone Height 400 mm Width 510 mm Depth: 540 430 mm opening height for lift-up door</p>	CG102M	02	VL8	253	269	285	300	319	347	377	-	-	-	10	10
	CG102M 02 VL8SLC														
 <p>Tall unit for appliances Niche height 450 mm 1 hinged door 1 fixed front panel 1 hinged door 2 adjustable shelves <i>One front panel per appliance type will be provided for adaptation on site.</i> <i>Cover strips for the microwave aperture (MZCVMW) are included for a charge and do not need to be factored into the order.</i> <i>Version supplied may deviate from the illustration according to appliance type.</i> For cladding up to the ceiling, provision must be made for a ventilation opening of min. 200 cm² in diameter.</p>	CGM	02	V6	184	196	204	216	235	247	264	-	-	-	10	10
	CGM 02 V6EE														
 <p>Tall unit for appliances niche height 1225 mm 1 appliance door 1 hinged door 1 adjustable shelf <i>niche size adjustment partially with infill panels.</i> <i>Version supplied may deviate from the illustration according to appliance type.</i> For cladding up to the ceiling, provision must be made for a ventilation opening of min. 200 cm² in diameter.</p>	CG122	02	V	165	177	189	203	233	253	280	-	-	-	10	10
	CG122 02 VSNL														

Illustrations do not correspond to front finishes / Door buffer = flap door stay buffer

5.139

Appliance housings with niche height 1225 mm

2115 mm high

Unit without plinth, carcass depth 560 mm

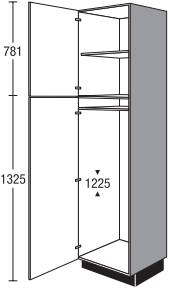
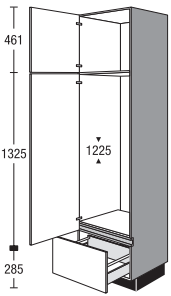
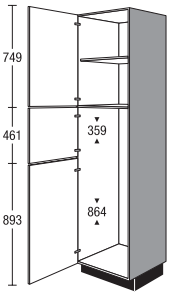
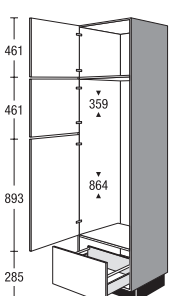
	CG	width	02	V9	Price group							Servosoft	Pro Servosoft	ProServoGlass	Soft closing Top Motion	Soft closing Top Motion Plus
					1	2	3	4	5	6	7					
 <p>Tall unit for appliances niche height 1225 mm</p> <p>1 hinged door 1 adjustable shelf 1 appliance door 1 fixed shelf</p> <p><i>niche size adjustment partially with infill panels.</i></p> <p><i>Version supplied may deviate from the illustration according to appliance type.</i></p> <p><i>For cladding up to the ceiling, provision must be made for a ventilation opening of min. 200 cm² in diameter.</i></p> <p>CG122 02 V9SNL</p>	CG122		02	V9	165	177	189	203	233	253	280	-	-	-	10	10
 <p>Tall unit for appliances niche height 1225 mm</p> <p>1 hinged door 1-2 appliance doors for opening together or separately, according to finish and type of appliance 1 deep drawer</p> <p><i>For cladding up to the ceiling, provision must be made for a ventilation opening of min. 200 cm² in diameter.</i></p> <p>CG122A 02 HVSNL</p>	CG122A		02	HV	204	217	229	243	273	290	315	5	8	16	10	10
 <p>Tall unit for appliances Recess height 359 mm Recess height 864 mm</p> <p>1 hinged door 1 adjustable shelf 2 hinged appliance doors</p> <p><i>niche size adjustment partially with infill panels.</i></p> <p><i>Version supplied may deviate from the illustration according to appliance type.</i></p> <p><i>For cladding up to the ceiling, provision must be made for a ventilation opening of min. 200 cm² in diameter.</i></p> <p>CG122 02 V3SNI</p>	CG122		02	V3	177	189	203	217	248	269	295	-	-	-	12	12
 <p>Tall unit for appliances Recess height 359 mm Recess height 864 mm</p> <p>1 hinged door 2 hinged appliance doors 1 deep drawer</p> <p><i>For cladding up to the ceiling, provision must be made for a ventilation opening of min. 200 cm² in diameter.</i></p> <p>CG122A 02 VSNL</p>	CG122A		02	V	207	221	233	247	276	294	306	5	8	16	12	12

5.140 Illustrations do not correspond to front finishes / Door buffer = flap door stay buffer

Appliance housings with niche height 1400 mm, Appliance housings with niche height 1445 mm, Appliance housings with niche height 1580 mm

2115 mm high

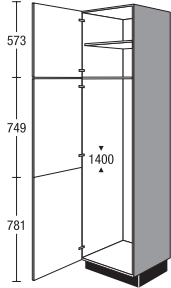
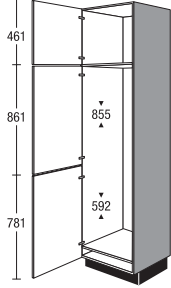
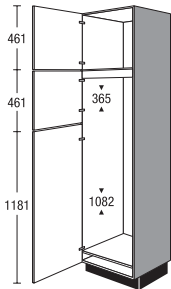
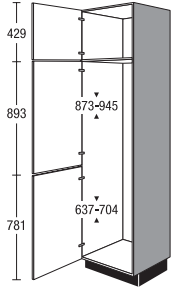
		width	Price group							Servosoft	Pro Servosoft	ProServodglass	Soft closing Top Motion	Soft closing Top Motion Plus	
			1	2	3	4	5	6	7						
 <p>Tall unit for appliances Niche height 1400 mm</p> <p>1 hinged door 1 adjustable shelf 1 hinged appliance door (pinned)</p> <p><i>niche size adjustment partially with infill panels.</i></p> <p><i>Version supplied may deviate from the illustration according to appliance type.</i></p> <p><i>For cladding up to the ceiling, provision must be made for a ventilation opening of min. 200 cm² in diameter.</i></p> <p>CG140 02 VSPA</p>	CG140	02	V	188	201	215	230	262	284	311	-	-	-	12	12
	 <p>Tall unit for appliances Recess height 855 mm Niche height 592 mm</p> <p>1 hinged door 2 hinged appliance doors</p> <p><i>niche size adjustment partially with infill panels.</i></p> <p><i>Version supplied may deviate from the illustration according to appliance type.</i></p> <p><i>For cladding up to the ceiling, provision must be made for a ventilation opening of min. 200 cm² in diameter.</i></p> <p>CG145 02 VSPE</p>	CG145	02	V	170	182	195	209	239	258	284	-	-	-	12
 <p>Tall unit for appliances Recess height 365 mm Recess height 1082 mm</p> <p>1 hinged door 2 hinged appliance doors</p> <p><i>niche size adjustment partially with infill panels.</i></p> <p><i>Version supplied may deviate from the illustration according to appliance type.</i></p> <p><i>For cladding up to the ceiling, provision must be made for a ventilation opening of min. 200 cm² in diameter.</i></p> <p>CG145 02 V8SPK</p>		CG145	02	V8	170	182	195	209	239	258	284	-	-	-	14
	 <p>Tall unit for appliances Recess height 873 - 945 mm Recess height 637 - 704 mm</p> <p>1 hinged door 2 hinged appliance doors</p> <p><i>niche size adjustment partially with infill panels.</i></p> <p><i>Version supplied may deviate from the illustration according to appliance type.</i></p> <p><i>For cladding up to the ceiling, provision must be made for a ventilation opening of min. 200 cm² in diameter.</i></p> <p>CG158 02 VSRL</p>	CG158	02	V	170	207	215	224	246	261	271	-	-	-	12

Illustrations do not correspond to front finishes / Door buffer = flap door stay buffer

5.141

Appliance housings with niche height 1780, 1890, 1940, 450 mm

2115 mm high

Unit without plinth, carcass depth 560 mm

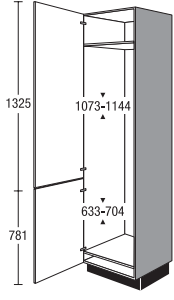
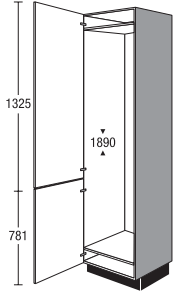
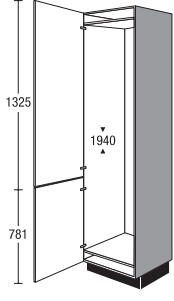
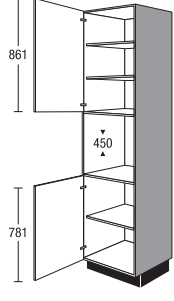
	width	Price group							Servosoft	Pro Servosoft	ProServoGlass	Soft closing Top Motion	Soft closing Top Motion Plus		
		1	2	3	4	5	6	7							
 <p>Tall unit for appliances Recess height 1073 - 1144 mm Recess height 633 - 704 mm 2 hinged appliance doors for opening together or separately, according to finish and type of appliance 1 fixed shelf <i>niche size adjustment partially with infill panels.</i> <i>Version supplied may deviate from the illustration according to appliance type.</i> <i>For cladding up to the ceiling, provision must be made for a ventilation opening of min. 200 cm² in diameter.</i></p> <p>CG178 02 VSTD</p>	CG178	02	V	170	183	193	202	228	252	282	-	-	-	10	10
 <p>Tall unit for appliances Recess height 1890 mm 2 hinged appliance doors <i>For cladding up to the ceiling, provision must be made for a ventilation opening of min. 200 cm² in diameter.</i></p> <p>CG189 02 VSUH</p>	CG189	02	V	170	183	193	202	228	252	282	-	-	-	10	10
 <p>Tall unit for appliances Recess height 1940 mm 2 hinged appliance doors <i>For cladding up to the ceiling, provision must be made for a ventilation opening of min. 200 cm² in diameter.</i></p> <p>CG194 02 FSVE</p>	CG194	02	V	170	183	193	202	228	252	282	-	-	-	10	10
 <p>Tall unit for appliances Niche height 450 mm 1 hinged door 2 adjustable shelves 1 hinged door 1 adjustable shelf <i>Cover strips for the microwave aperture (MZCVMW) are included for a charge and do not need to be factored into the order.</i></p> <p>CGM 02 VEE</p>	CGM	02	V	173	183	192	203	221	231	248	-	-	-	8	8

5.142 Illustrations do not correspond to front finishes / Door buffer = flap door stay buffer

Appliance housings with niche height 450 mm

2115 mm high

Unit without plinth, carcass depth 560 mm

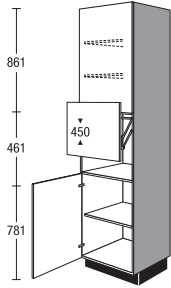
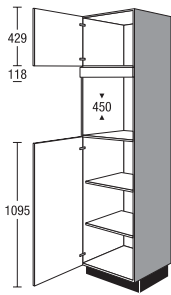
		width	Price group							Servosoft	Pro Servosoft	ProServoglass	Soft closing Top Motion	Soft closing Top Motion Plus	
			1	2	3	4	5	6	7						
 <p>Tall unit for appliances with lift-up door Niche height 450 mm same as above, but plus 1 lift-up door</p> <p>Maximum size of stand-alone Height 400 mm Width 510 mm Depth: 540</p> <p>430 mm opening height for lift-up door</p> <p>CGM 02 VL</p>	CGM	02	VL	240	254	267	281	306	322	344	-	-	-	8	8
	 <p>Tall unit for appliances Niche height 450 mm</p> <p>1 hinged door 1 fixed front panel 1 hinged door 2 adjustable shelves</p> <p><i>One front panel per appliance type will be provided for adaptation on site.</i></p> <p><i>Cover strips for the microwave aperture (MZCVMW) are included for a charge and do not need to be factored into the order.</i></p> <p><i>Version supplied may deviate from the illustration according to appliance type.</i></p> <p><i>For cladding up to the ceiling, provision must be made for a ventilation opening of min. 200 cm² in diameter.</i></p> <p>CGM 02 V6EE</p>	CGM	02	V6	184	196	204	216	235	247	264	-	-	-	10

Illustrations do not correspond to front finishes / Door buffer = flap door stay buffer

5.143

Appliance housings with niche height 450 mm, Appliance housings with niche height 590 mm

2115 mm high

Unit without plinth, carcass depth 560 mm

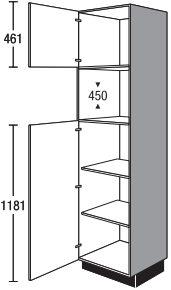
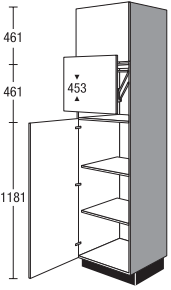
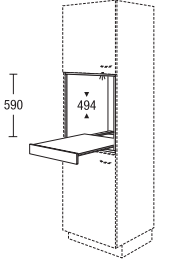
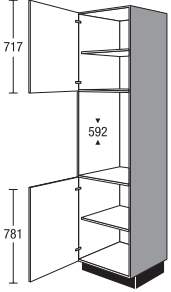
	CGM	width	02	V8	Price group							Servosoft	Pro Servosoft	ProServoGlass	Soft closing Top Motion	Soft closing Top Motion Plus
					1	2	3	4	5	6	7					
 <p>Tall unit for appliances Niche height 450 mm</p> <p>1 hinged door 1 hinged door 2 adjustable shelves</p> <p><i>Recess sizes are adjusted in part through the use of carcass panels.</i></p> <p><i>Cover strips for the microwave aperture (MZCVMW) are included for a charge and do not need to be factored into the order.</i></p> <p>CGM 02 V8EE</p>	CGM		02	V8	173	183	192	203	221	231	248	-	-	-	10	10
 <p>Tall unit for appliances with lift-up door Recess height 453 mm</p> <p>same as above, but plus 1 lift-up door</p> <p>Maximum size of stand-alone Height 400 mm Width 510 mm Depth: 540</p> <p>430 mm opening height for lift-up door</p> <p>CGM 02 VL8</p>	CGM		02	VL8	240	254	267	281	306	322	344	-	-	-	10	10
 <p>Modular built in shelf unit for highboard / tall unit</p> <p>for niche heights 590 mm Depth: 505 mm</p> <p>1 pull-out shelf</p> <p><i>Finish in carcass material</i></p> <p><i>Not available in visible side colours.</i></p>	MR	60	59	TA	201	201	201	201	201	201	201	-	-	-	-	-
 <p>Tall unit for appliances Niche height 592 mm</p> <p>1 hinged door 1 adjustable shelf 1 hinged door 1 adjustable shelf</p> <p><i>For foil-wrapped fronts a set of heat deflector plates are supplied free of charge.</i></p> <p><i>Cover strips for the oven aperture (MZCVB0) are included for a charge and do not need to be factored into the order.</i></p> <p>CGB 02 VFB</p>	CGB		02	V	172	181	190	200	217	228	243	-	-	-	8	8

5.144 Illustrations do not correspond to front finishes / Door buffer = flap door stay buffer

Appliance housings with niche height 590 mm

2115 mm high

Unit without plinth, carcass depth 560 mm

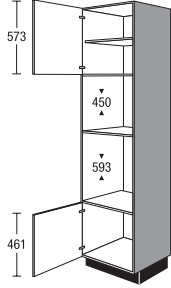
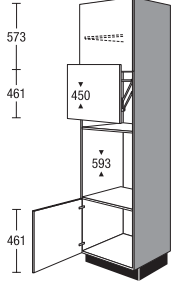
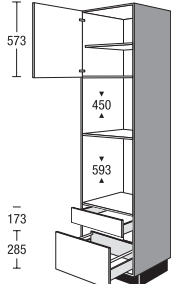
				Price group												
				width	1	2	3	4	5	6	7	Servosoft	Pro Servosoft	ProServoglass	Soft closing Top Motion	Soft closing Top Motion Plus
 <p>Tall unit for appliances Niche height 450 mm Niche height 593 mm</p> <p>1 hinged door 1 adjustable shelf 1 hinged door</p> <p><i>For foil-wrapped fronts a set of heat deflector plates are supplied free of charge.</i></p> <p><i>Cover strips for the microwave aperture (MZCVMW) as well as for the oven aperture (MZCVBO) are included for a charge and do not need to be factored into the order.</i></p> <p>CGMB 02 VQLD</p>	CGMB	02	VQ	163	182	191	201	213	233	256	-	-	-	8	8	
	 <p>Tall unit for appliances with lift-up door Niche height 450 mm Niche height 593 mm</p> <p>same as above, but plus 1 lift-up door</p> <p>Maximum size of stand-alone Height 400 mm Width 510 mm Depth: 540</p> <p>430 mm opening height for lift-up door</p> <p><i>Cover strips for the oven aperture (MZCVBO) are included for a charge and do not need to be factored into the order.</i></p> <p>CGMB 02 VLQFB</p>	CGMB	02	VLQ	230	257	270	283	300	329	362	-	-	-	8	8
 <p>Tall unit for appliances Niche height 450 mm Niche height 593 mm</p> <p>1 hinged door 1 adjustable shelf 1 drawer 1 deep drawer</p> <p><i>For foil-wrapped fronts a set of heat deflector plates are supplied free of charge.</i></p> <p><i>Cover strips for the microwave aperture (MZCVMW) as well as for the oven aperture (MZCVBO) are included for a charge and do not need to be factored into the order.</i></p> <p>CGMBSA 02 VQLD</p>		CGMBSA	02	VQ	206	230	242	253	270	295	324	10	16	24	4	4

Illustrations do not correspond to front finishes / Door buffer = flap door stay buffer

5.145

Appliance housings with niche height 590 mm, Shelf units, Fillers

2115 mm high

Unit without plinth, carcass depth 560 mm

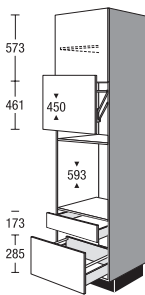
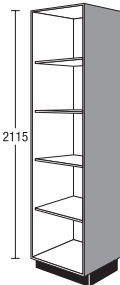
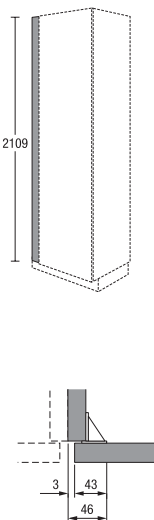
	CGMBSA	width	Price group							Servosoft	Pro Servosoft	ProServoGlass	Soft closing Top Motion	Soft closing Top Motion Plus	
			1	2	3	4	5	6	7						
 <p>Tall unit for appliances with lift-up door Niche height 450 mm Niche height 593 mm same as above, but plus 1 lift-up door Maximum size of stand-alone Height 400 mm Width 510 mm Depth: 540 430 mm opening height for lift-up door Cover strips for the oven aperture (MZCVB0) are included for a charge and do not need to be factored into the order.</p> <p>CGMBSA 02 VLQFB</p>	CGMBSA	02	VLQ	274	305	321	336	357	391	430	10	16	24	4	4
 <p>Tall shelf unit 4 adjustable shelves Finish in carcass material Please indicate desired width (150-600 mm). Not available in visible side colours.</p>	CSR	V	02	234	234	234	234	234	234	234	-	-	-	-	-
 <p>Infill panel for tall unit without plinth, 2115 mm high Fitted between wall and carcass side Finish in continuous door material without edging on the wall side Not available for the following fronts: IP 2200, Vintage oak effect no. 138 IP 2200, Light oak effect no. 141 IP 2200, Oregon oak effect no. 142 IP 2200, Oak effect black no. 143 IP 2200, Summerfield oak effect no. 163 Not available in visible side colours. Due to the installation angle, the maximum possible on-site width reduction is 46 mm.</p>	CSPF	10	02 E	30	33	35	36	38	42	46	-	-	-	-	-
	CSPF	20	02 E	41	44	47	49	54	59	65	-	-	-	-	-

5.146 Illustrations do not correspond to front finishes / Door buffer = flap door stay buffer

Fillers

2115 mm high

with neutral door division

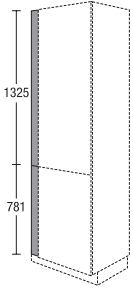
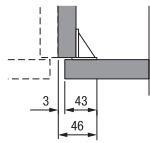
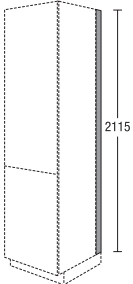
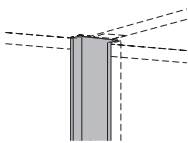
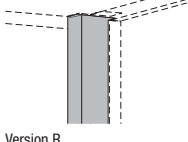
		width	Price group							Servosoft	Pro Servosoft	ProServoglass	Soft closing Top Motion	Soft closing Top Motion Plus			
			1	2	3	4	5	6	7								
 <p>Infill panel for tall unit without plinth, 2115 mm high Fitted between wall and carcass side</p> <p><i>Finish in door material without edging on the wall side</i></p> <p><i>Available for the following fronts: IP 2200, Vintage oak effect no. 138 IP 2200, Light oak effect no. 141 IP 2200, Oregon oak effect no. 142 IP 2200, Oak effect black no. 143 IP 2200, Summerfield oak effect no. 163</i></p> <p><i>Not available in visible side colours.</i></p> <p><i>Due to the installation angle, the maximum possible on-site width reduction is 46 mm.</i></p> 	CSPF	10	02	V	30	33	35	36	38	42	46	-	-	-	-	-	
		CSPF	20	02	V	41	44	47	49	54	59	65	-	-	-	-	-
 <p>Infill panel for tall-unit side without plinth, 2115 mm high 16 mm deep for wall end</p> <p><i>Finish laminate, stainless steel look</i></p> <p><i>for deeper tops, order plinth SO 151 separately</i></p>	CDTS		02		12	12	12	12	12	12	12	12	-	-	-	-	-
 <p>Recessed grip For planning between units</p>	CVC		02		38	38	38	38	38	38	38	38	-	-	-	-	-
 <p>Recessed grip For planning individual tall units or alongside a panel</p> <p>Version R</p>	CVL CVL		02 02	L R	34 34	34 34	34 34	34 34	34 34	34 34	34 34	34 34	-	-	-	-	-

Illustrations do not correspond to front finishes / Door buffer = flap door stay buffer

5.147

Tall units

2259 mm high

Unit without plinth, carcass depth 560 mm

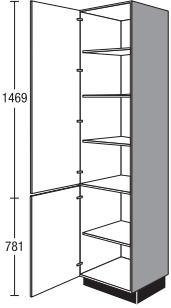
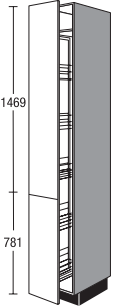
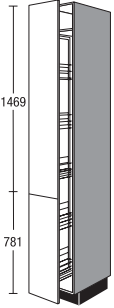
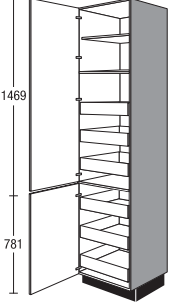
			width	Price group							Servosoft	Pro Servosoft	ProServoGlass	Soft closing Top Motion	Soft closing Top Motion Plus		
				1	2	3	4	5	6	7							
 <p>Tall unit 1 hinged door 3 adjustable shelves 1 hinged door 1 adjustable shelf</p>	<input checked="" type="checkbox"/>	CS	30	03	V	141	155	162	170	192	206	227	-	-	-	12	12
	<input checked="" type="checkbox"/>	CS	45	03	V	174	191	198	212	235	255	281	-	-	-	12	12
	<input checked="" type="checkbox"/>	CS	50	03	V	180	193	204	218	240	261	288	-	-	-	12	12
	<input checked="" type="checkbox"/>	CS	60	03	V	181	194	206	219	243	263	289	-	-	-	12	12
 <p>Pull-out tall unit with wire baskets, silver grey 1 full-extension pull-out with cushioning consisting of 2 fronts 1 fixed shelf 5 adjustable baskets</p>		CSA	30	03	V	297	310	314	316	330	340	357	36	36	36	-	-
 <p>Pull-out tall unit Baskets with wooden shelf and metal rail 1 full-extension pull-out with cushioning consisting of 2 fronts 1 fixed shelf 5 adjustable baskets</p>		CSA	30	03	VP	380	399	402	406	420	430	454	-	-	-	-	-
 <p>Tall unit 1 hinged door 1 adjustable shelf 1 fixed shelf 3 interior drawers 1 hinged door 3 interior drawers</p> <p><i>When planning next to a wall, the hinged doors must be able to open 90°. Door must not be hinged on side adjacent to the worktop.</i></p>	<input checked="" type="checkbox"/>	CS	30	03	VIS	280	301	314	329	361	385	418	30	48	48	12	12
	<input checked="" type="checkbox"/>	CS	45	03	VIS	300	323	339	356	388	415	446	30	48	48	12	12
	<input checked="" type="checkbox"/>	CS	50	03	VIS	310	334	351	369	403	430	461	30	48	48	12	12
	<input checked="" type="checkbox"/>	CS	60	03	VIS	321	345	362	382	416	445	478	30	48	48	12	12

5.148 Illustrations do not correspond to front finishes / Door buffer = flap door stay buffer

Tall units, Appliance housings with niche height 1780 mm, Appliance housings with niche height 590 mm

2259 mm high

Unit without plinth, carcass depth 560 mm

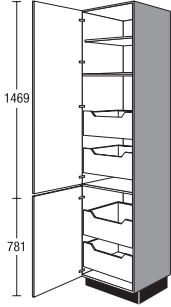
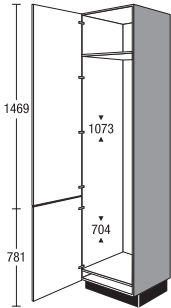
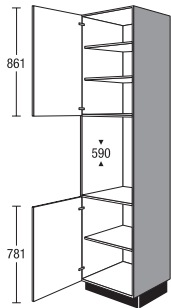
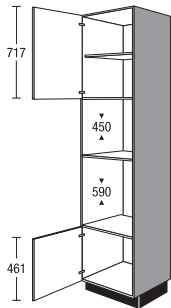
		Price group															
		width	1	2	3	4	5	6	7	Servosoft	Pro Servosoft	ProServoglass	Soft closing Top Motion	Soft closing Top Motion Plus			
 <p>Tall unit</p> <ul style="list-style-type: none"> 1 hinged door 1 adjustable shelf 1 fixed shelf 2 interior deep drawers 1 hinged door 2 interior deep drawers <p><i>When planning at the beginning of a wall, it must be possible to open the hinged doors by 90° (observe handle distance) Door must not be hinged on side adjacent to the worktop.</i></p>	NEW	CS	30	03	VIA	253	269	281	294	326	351	388	20	32	64	12	12
	NEW	CS	45	03	VIA	274	290	305	319	350	378	415	20	32	64	12	12
	NEW	CS	50	03	VIA	280	298	311	327	358	386	424	20	32	64	12	12
	NEW	CS	60	03	VIA	293	312	326	342	375	405	444	20	32	64	12	12
 <p>Tall unit for appliances niche height 1780 mm</p> <ul style="list-style-type: none"> 2 hinged appliance doors for opening together or separately, according to finish and type of appliance 1 fixed shelf <p><i>niche size adjustment partially with infill panels.</i></p> <p><i>Version supplied may deviate from the illustration according to appliance type.</i></p> <p><i>For cladding up to the ceiling, provision must be made for a ventilation opening of min. 200 cm² in diameter.</i></p>	CG178	03	V	185	196	209	217	243	266	296	-	-	-	12	12		
CG178 03 VSTD																	
 <p>Tall unit for appliances niche height 590 mm</p> <ul style="list-style-type: none"> 1 hinged door 1 adjustable shelf 1 hinged door 1 adjustable shelf <p><i>For foil-wrapped fronts a set of heat deflector plates are supplied free of charge.</i></p> <p><i>Cover strips for the oven aperture (MZCVBO) are included for a charge and do not need to be factored into the order.</i></p>	CGB	03	V	179	189	200	212	232	246	263	-	-	-	8	8		
CGB 03 VFB																	
 <p>Tall unit for appliances Niche height 450 mm niche height 590 mm</p> <ul style="list-style-type: none"> 1 hinged door 1 adjustable shelf 1 hinged door <p><i>For foil-wrapped fronts a set of heat deflector plates are supplied free of charge.</i></p> <p><i>Cover strips for the microwave aperture (MZCVMW) as well as for the oven aperture (MZCVBO) are included for a charge and do not need to be factored into the order.</i></p>	CGMB	03	VQ	173	194	204	217	232	254	280	-	-	-	8	8		
CGMB 03 VQLD																	

Illustrations do not correspond to front finishes / Door buffer = flap door stay buffer

5.149

Appliance housings with niche height 590 mm, Fillers

2259 mm high

Unit without plinth, carcass depth 560 mm

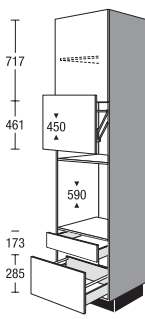
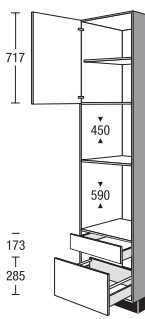
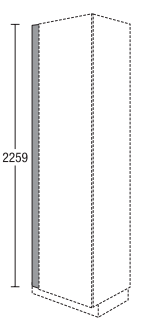
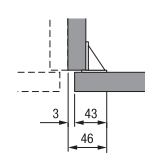
	CGMBSA	width	03	VLQ	Price group							Servosoft	Pro Servosoft	ProServoGlass	Soft closing Top Motion	Soft closing Top Motion Plus
					1	2	3	4	5	6	7					
 <p>Tall unit for appliances with lift-up door Niche height 450 mm niche height 590 mm same as above, but plus 1 lift-up door</p> <p>Maximum size of stand-alone Height 400 mm Width 510 mm Depth: 540</p> <p>430 mm opening height for lift-up door</p> <p><i>Cover strips for the oven aperture (MZCVB0) are included for a charge and do not need to be factored into the order.</i></p> <p>CGMBSA 03 VLQFB</p>	CGMBSA		03	VLQ	285	317	337	352	380	416	461	10	16	24	4	4
 <p>Tall unit for appliances Niche height 450 mm niche height 590 mm</p> <p>1 hinged door 1 adjustable shelf 1 drawer 1 deep drawer</p> <p><i>For foil-wrapped fronts a set of heat deflector plates are supplied free of charge.</i></p> <p><i>Cover strips for the microwave aperture (MZCVMW) as well as for the oven aperture (MZCVB0) are included for a charge and do not need to be factored into the order.</i></p> <p>CGMBSA 03 VQLD</p>	CGMBSA		03	VQ	216	242	256	268	291	317	350	10	16	24	4	4
 <p>Infill panel for tall unit without plinth, 2259 mm high Fitted between wall and carcass side</p> <p><i>Finish in continuous door material without edging on the wall side</i></p> <p><i>Not available for the following fronts: IP 2200, Vintage oak effect no. 138 IP 2200, Light oak effect no. 141 IP 2200, Oregon oak effect no. 142 IP 2200, Oak effect black no. 143 IP 2200, Summerfield oak effect no. 163</i></p> <p><i>Not available in visible side colours.</i></p> <p><i>Due to the installation angle, the maximum possible on-site width reduction is 46 mm.</i></p> 	CSPF	10	03	E	31	33	36	37	39	44	47	-	-	-	-	-
	CSPF	20	03	E	45	48	52	53	56	61	67	-	-	-	-	-

5.150 Illustrations do not correspond to front finishes / Door buffer = flap door stay buffer

Fillers

2259 mm high

with neutral door division

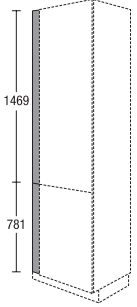
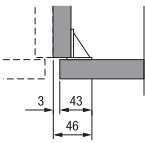
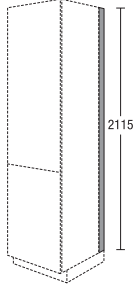
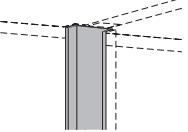
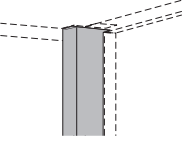
		width	Price group							Servosoft	Pro Servosoft	ProServoglass	Soft closing Top Motion	Soft closing Top Motion Plus			
			1	2	3	4	5	6	7								
 <p>Infill panel for tall unit without plinth, 2259 mm high Fitted between wall and carcass side</p> <p><i>Finish in door material without edging on the wall side</i></p> <p><i>Available for the following fronts: IP 2200, Vintage oak effect no. 138 IP 2200, Light oak effect no. 141 IP 2200, Oregon oak effect no. 142 IP 2200, Oak effect black no. 143 IP 2200, Summerfield oak effect no. 163</i></p> <p><i>Not available in visible side colours.</i></p> <p><i>Due to the installation angle, the maximum possible on-site width reduction is 46 mm.</i></p> 	CSPF	10	03	V	31	33	36	37	39	44	47	-	-	-	-	-	
		CSPF	20	03	V	45	48	52	53	56	61	67	-	-	-	-	-
 <p>Infill panel for tall-unit side without plinth, 2259 mm high 16 mm deep for wall end</p> <p><i>Finish laminate, stainless steel look</i></p> <p><i>for deeper tops, order plinth SO 151 separately</i></p>	CDTS		03		13	13	13	13	13	13	13	13	-	-	-	-	-
 <p>Recessed grip For planning between units</p>	CVC		03		40	40	40	40	40	40	40	40	-	-	-	-	-
 <p>Recessed grip For planning individual tall units or alongside a panel</p> <p>Version R</p>	CVL CVL		03 03	L R	36 36	36 36	36 36	36 36	36 36	36 36	36 36	36 36	-	-	-	-	-

Illustrations do not correspond to front finishes / Door buffer = flap door stay buffer

5.151

Notes

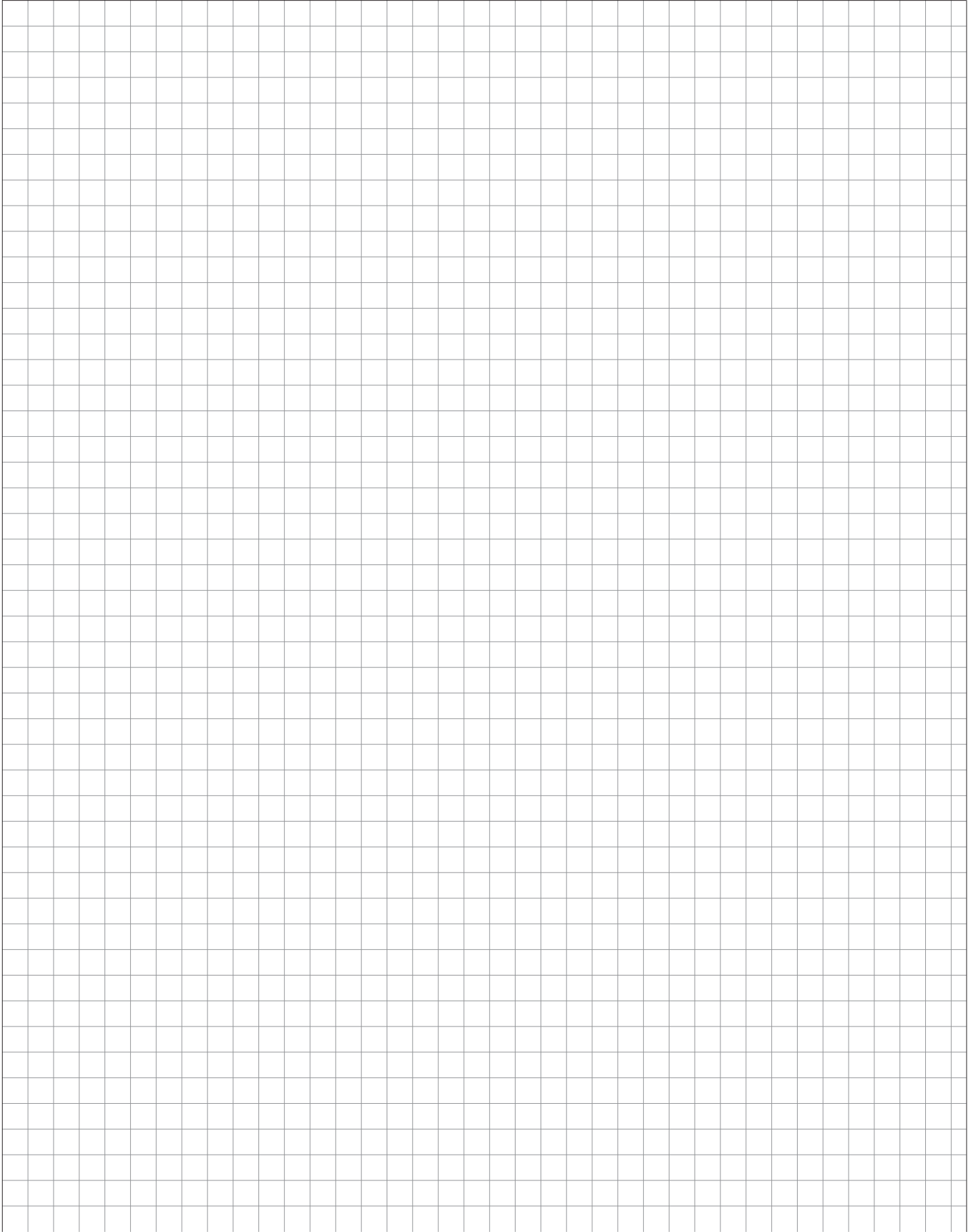

Modular panel system

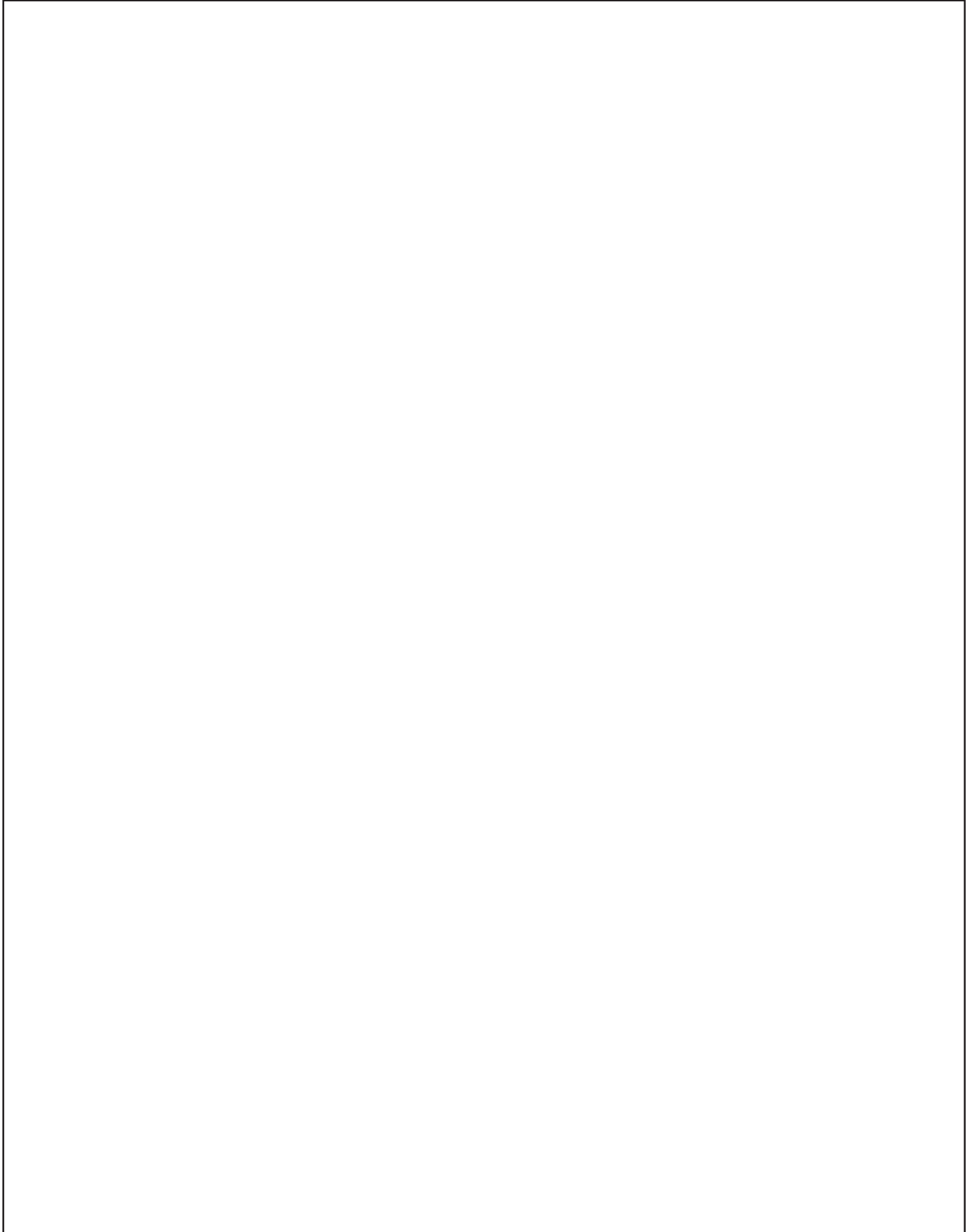



Modular panel system

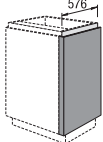
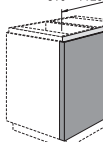

Modular panel system

Front panels

	width	Price group							Servosoft	Pro Servosoft	ProServoglass	Soft closing Top Motion	Soft closing Top Motion Plus	
		1	2	3	4	5	6	7						
 <p>Front panel For row ends Front material with recessed grip <i>576 mm deep for carcass depth 560 mm</i> <i>Planning dimension: 53 mm</i> <i>Do not plan front panels directly adjacent to appliances.</i> <i>Please state carcass depth when ordering.</i></p>	CWUF53	60		152	155	157	159	170	189	211	-	-	-	-
	CWUF 53	60	CKM	-	-	-	-	-	189	211	-	-	-	-
	CWUF53	V		177	180	182	184	195	214	236	-	-	-	-
	CWUF53	V	CKM	-	-	-	-	-	214	236	-	-	-	-
 <p>Front panel variable in dimensions For row ends Front material with recessed grip <i>Variable for carcass depth 310 - 1120 mm</i> <i>Planning dimension: 53 mm</i> <i>Do not plan front panels directly adjacent to appliances.</i> <i>Please state carcass depth when ordering.</i></p>	CWUF53	V		182	185	187	189	200	219	241	-	-	-	-
	CWUF53	V	ICKM	-	-	-	-	-	219	241	-	-	-	-
	CWUF53	93	I	163	166	168	170	181	200	222	-	-	-	-
	CWUF 53	93	ICKM	-	-	-	-	-	200	222	-	-	-	-
 <p>Front panel for island plans Front material with recessed grip <i>For carcass depth 560 + 326 mm</i> <i>Planning dimension: 53 mm</i> <i>Do not plan front panels directly adjacent to appliances.</i> <i>Please state carcass depth when ordering.</i></p>	CWUF53	93	I	163	166	168	170	181	200	222	-	-	-	-
	CWUF 53	93	ICKM	-	-	-	-	-	200	222	-	-	-	-

Modular panels, Modular panel system 16 mm

Modular panel system 16 mm

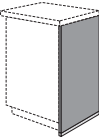
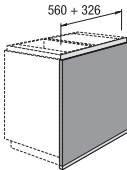
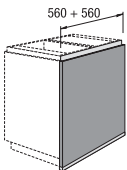
			width		universal		
<p>Modular panels 16 mm thick with ABS edge on all sides <i>Colour version see panel colours 16 mm</i> The plinth height will be automatically calculated into the base unit, highboard and tall unit panels. The colour of the panel supports is chosen in the order header. Available panel support colours: 558 Stainless steel coloured 951 Black If no colour is stated with the order, delivery will be in 558 stainless steel coloured.</p>							
	<p>Modular panel for base unit floor-length with panel protector 598 mm deep</p>	787 mm high = carcass height Finish matt	CWU	16		37	
		787 mm high = carcass height Finish matt lacquer	CWU	16	M	48	
		787 mm high = carcass height Finish high-gloss	CWU	16	HG	48	
		787 mm high = carcass height Finish Colour Concept	CWU	16	CKM	84	
	<p>Panel for island plans floor-length with panel protector For carcass depth 560 + 326 mm</p>	787 mm high = carcass height plus plinth height Finish matt	CWU	16	93	56	
		787 mm high = carcass height plus plinth height Finish matt lacquer	CWU	16	93	M	74
		787 mm high = carcass height plus plinth height Finish high-gloss	CWU	16	93	HG	74
		787 mm high = carcass height plus plinth height Finish Colour Concept	CWU	16	93	CKM	141
	<p>Panel for island plans floor-length with panel protector For carcass depth 560 + 560 mm</p>	787 mm high = carcass height plus plinth height Finish matt	CWU	16	117	66	
		787 mm high = carcass height plus plinth height Finish matt lacquer	CWU	16	117	M	91
		787 mm high = carcass height plus plinth height Finish high-gloss	CWU	16	117	HG	91
		787 mm high = carcass height plus plinth height Finish Colour Concept	CWU	16	117	CKM	176

Modular panel system 16 mm

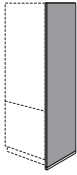
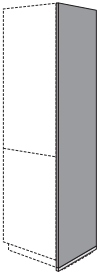
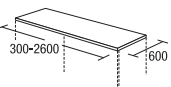
			width	universal
 <p>Modular panel for highboard floor-length with panel protector 598 mm deep</p>	1507 mm high = carcass height Finish matt	CWS	16 151	60
	1507 mm high = carcass height Finish matt lacquer	CWS	16 151 M	80
	1507 mm high = carcass height Finish high-gloss	CWS	16 151 HG	80
	1507 mm high = carcass height Finish Colour Concept	CWS	16 151 CKM	150
 <p>Modular panel for tall unit floor-length with panel protector 598 mm deep</p>	1971 mm high = carcass height Finish matt	CWS	16 01	75
	1971 mm high = carcass height Finish matt lacquer	CWS	16 01 M	101
	1971 mm high = carcass height Finish high-gloss	CWS	16 01 HG	101
	1971 mm high = carcass height Finish Colour Concept	CWS	16 01 CKM	187
	2115 mm high = carcass height Finish matt	CWS	16 02	80
	2115 mm high = carcass height Finish matt lacquer	CWS	16 02 M	107
	2115 mm high = carcass height Finish high-gloss	CWS	16 02 HG	107
	2115 mm high = carcass height Finish Colour Concept	CWS	16 02 CKM	199
	2259 mm high = carcass height Finish matt	CWS	16 03	85
	2259 mm high = carcass height Finish matt lacquer	CWS	16 03 M	114
	2259 mm high = carcass height Finish high-gloss	CWS	16 03 HG	114
	2259 mm high = carcass height Finish Colour Concept	CWS	16 03 CKM	211
	 <p>Top panel for highboard / tall unit Depth 600 mm <i>Not suitable as a worktop replacement.</i> <i>Calculated per mm</i></p>	Per metre started Finish matt	CWB	16 600

Modular panel system 16 mm

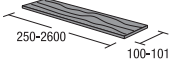
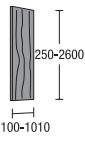
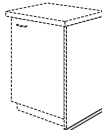
			width		universal
 <p>Modular panel in variable sizes grain direction horizontal</p> <p>Variable width 250 - 2600 mm Variable depth 100-1010 mm</p> <p><i>Not suitable as a worktop replacement.</i></p> <p><i>Calculated per mm²</i> <i>Minimum size calculated = 0.5 m²</i></p>	per m ² Finish matt	CWB	16	H	55
	per m ² Finish matt lacquer	CWB	16	HM	75
	per m ² Finish high-gloss	CWB	16	HHG	75
	per m ² Finish Colour Concept	CWB	16	HCKM	154
 <p>Modular panel in variable sizes grain direction vertical</p> <p>Variable height 250 - 2600 mm Variable depth 100-1010 mm</p> <p><i>Not suitable as a worktop replacement.</i></p> <p><i>Calculated per mm²</i> <i>Minimum size calculated = 0.5 m²</i></p> <p><i>Panel shoe must be ordered separately.</i></p>	per m ² Finish matt	CWB	16	V	55
	per m ² Finish matt lacquer	CWB	16	VM	75
	per m ² Finish high-gloss	CWB	16	VHG	75
	per m ² Finish Colour Concept	CWB	16	VCKM	154
 <p>Panel shoe for 16 mm thick modular panels</p> <p><i>The end cap of the panel shoe must be ordered separately for freestanding solutions / island solutions.</i></p>	598 mm deep	WASCH	16	598	6
	885 mm deep	WASCH	16	885	7
	1200 mm deep	WASCH	16	1200	9
		WASCH	16	EK	1
<p>End cap for panel shoe for 16 mm panel shoes</p> <p><i>For free-standing / island solutions.</i></p>					

Individual parts, miscellaneous

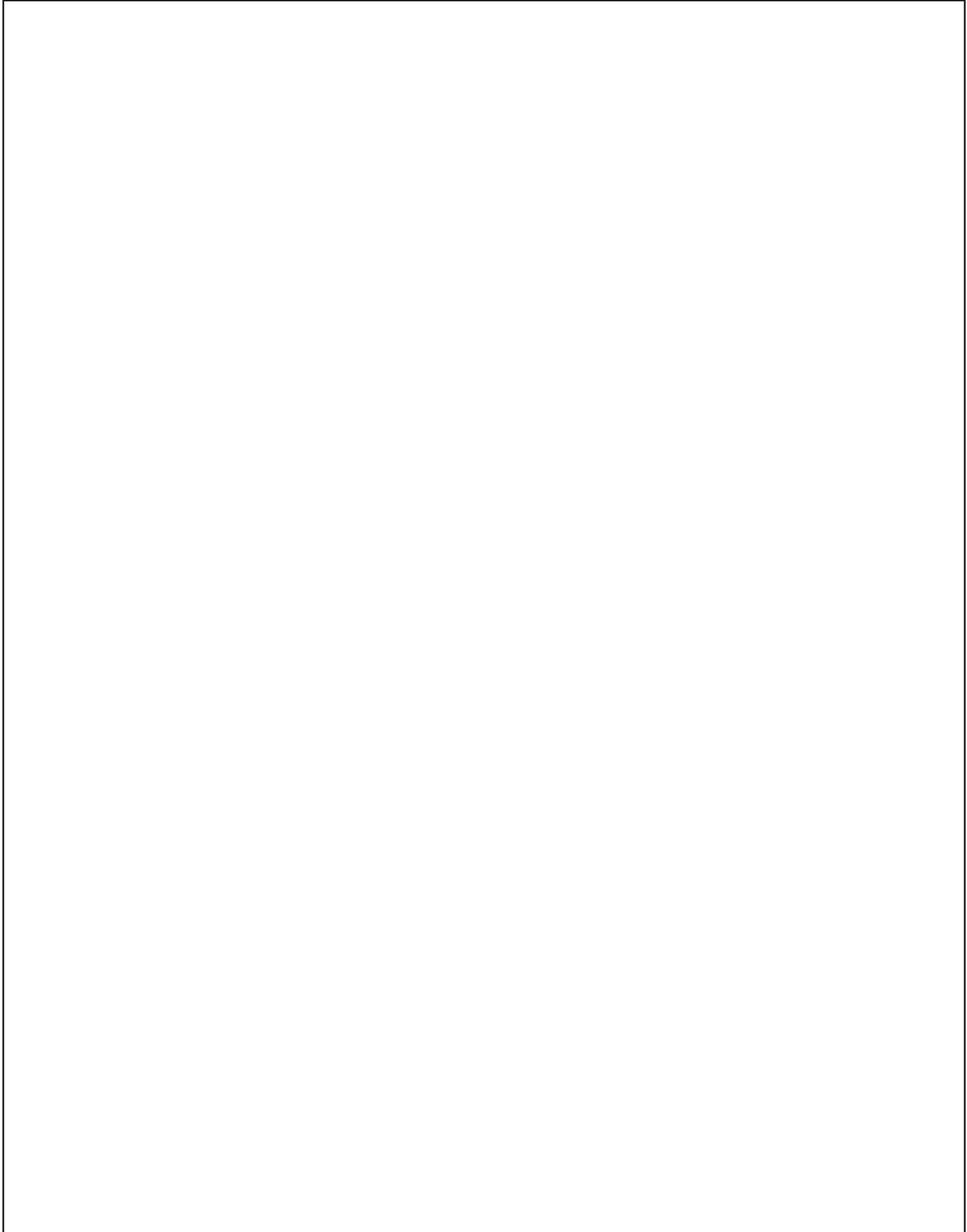



Individual parts,
miscellaneous

Individual parts,
miscellaneous

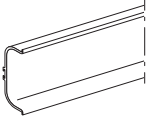
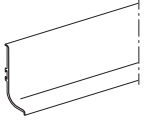
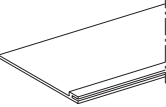
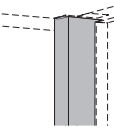
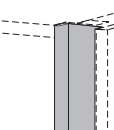
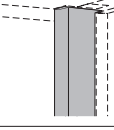
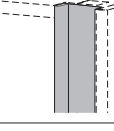
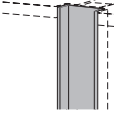

Individual parts, Miscellaneous

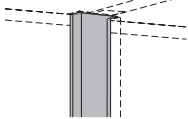
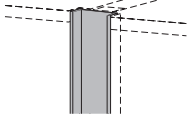
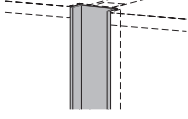
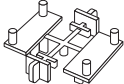
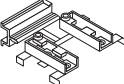
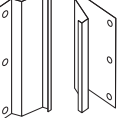
		width	universal		
	<p>Recessed grip C profile horizontal for separate plinth Maximum length: 4000 mm Calculated per mm</p>	per metre	CCPH	37	
	<p>Recessed grip L profile horizontal for separate plinth Maximum length: 4000 mm Calculated per mm</p>	per metre	CLPH	35	
	<p>Vapour guard plastic above dishwashers 60 mm deep, 1.5 mm thick For additional order</p>	for width 450 for width 600	ZVC449 ZVC599	4 2	
 Version R	<p>Recessed grip For planning individual highboards or alongside a panel</p>	1507 mm high = carcass height for highboard left	CVL	151 L	28
		1507 mm high = carcass height for highboard right	CVL	151 R	28
	<p>Recessed grip For planning individual tall units or alongside a panel</p>	1971 mm high = carcass height for tall unit height 01 left	CVL	01 L	32
		1971 mm high = carcass height for tall unit height 01 right	CVL	01 R	32
	<p>Recessed grip For planning individual tall units or alongside a panel</p>	2115 mm high = carcass height for tall unit height 02 left	CVL	02 L	34
		2115 mm high = carcass height for tall unit height 02 right	CVL	02 R	34
	<p>Recessed grip For planning individual tall units or alongside a panel</p>	2259 mm high = carcass height for tall unit height 03 left	CVL	03 L	36
		2259 mm high = carcass height for tall unit height 03 right	CVL	03 R	36
	<p>Recessed grip For planning between units</p>	1507 mm high = carcass height for highboard	CVC	151	30

Individual parts, Miscellaneous

			width	universal
 <p>Recessed grip For planning between units</p>	1971 mm high = carcass height for tall unit height 01	CVC	01	36
 <p>Recessed grip For planning between units</p>	2115 mm high = carcass height for tall unit height 02	CVC	02	38
 <p>Recessed grip For planning between units</p>	2259 mm high = carcass height for tall unit height 03	CVC	03	40
 <p>Installation set for horizontal handle profile <i>Laminate finish</i></p>	1 each	MZCH		1
 <p>Installation set for vertical handle profile <i>Laminate finish</i></p>	1 each	MZCV1		1
 <p>Installation set Distance and positioning aid for vertical handle profile <i>Finish metal</i></p>	1 pair	MZCV2		2
 <p>Cover strip for oven aperture Finish metal Colour finish: Stainless steel effect no. 960 Black no. 970 White no. 980 Copper effect no. 990 <i>Length: 580 mm</i></p>	1 each	MZCVB0		13
<p>Cover strip for microwave aperture Finish metal Colour finish: Stainless steel effect no. 960 Black no. 970 White no. 980 Copper effect no. 990 <i>Length: 440 mm</i></p>	1 each ^{NEW}	MZCVMW		13

Individual parts, Miscellaneous

			width	universal
<p>Surcharge for recessed grip milling for induction hobs For ventilation below the worktop <i>Specify appliance type</i></p>		CLHFIK		8
 <p>Corners and end caps Use: for C handle profile <i>Laminate finish</i></p>	End caps 1 left, 1 right	CCHEK		1
	1 inner and 1 outer corner	CCHIA		1
 <p>Corners and end caps Use: for C handle profile <i>Laminate finish</i></p>	In combination with a split dishwasher front	CCHEK	2	1
 <p>Assembly instructions</p>	Product range C	CM01		0

Notes

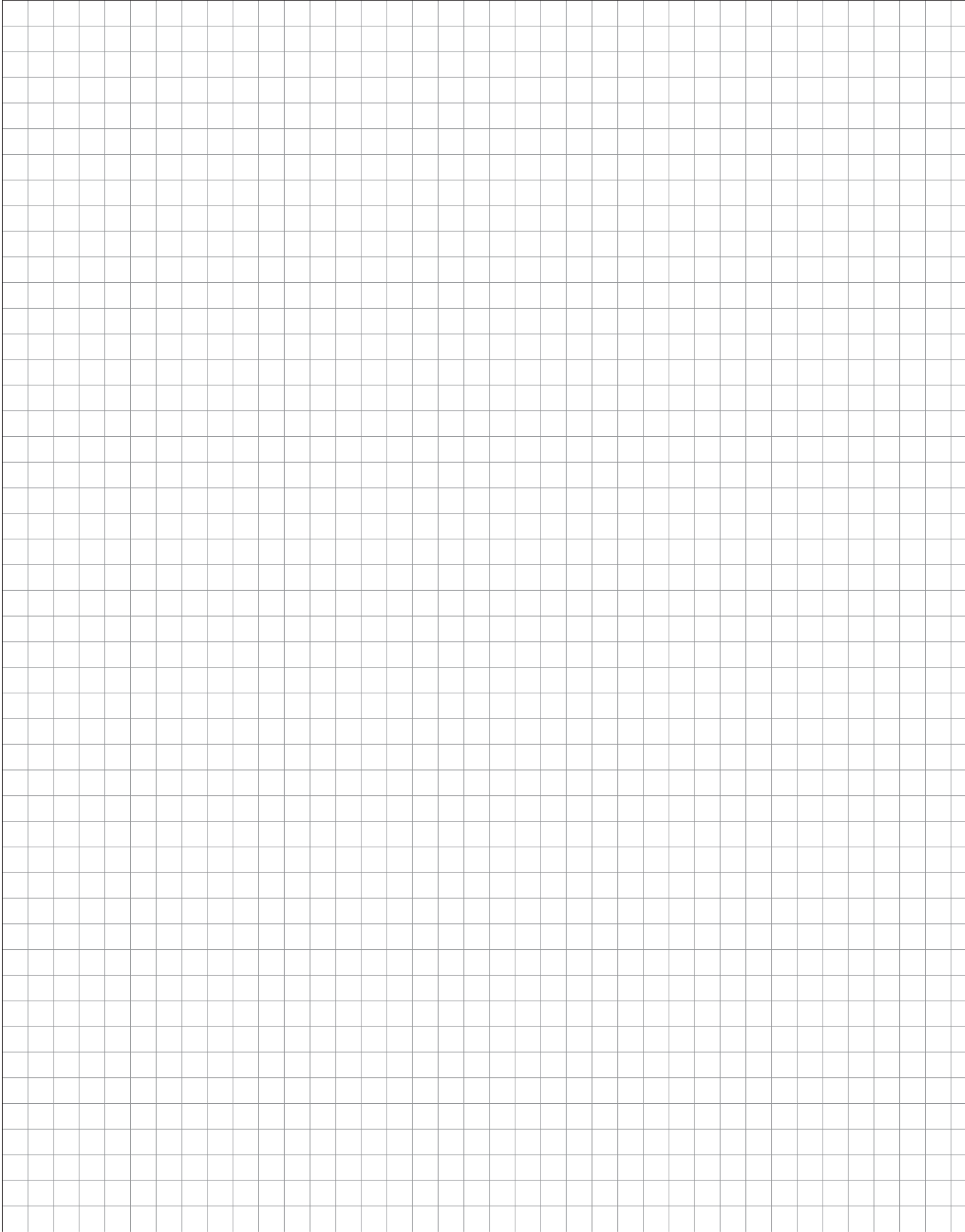

6. Panels, shelves, back cladding

Modular panel system 16 mm
Modular panel system 25 mm
Shelves
Back panel

6. Panels, shelves, back cladding

Panel colours 16 mm

Matt

111 Light oak effect
112 Cappuccino
114 Black oak effect
117 Hunton oak effect
120 Black
121 Thyme
128 Wild west
132 Slate grey
133 Volcano brown
134 Alby blue
146 Black slate texture
147 Marble green
148 Jupiter sand
149 Copper slate texture
151 Marble white
158 Sage green
160 Summerfield oak effect

Matt lacquer

144 Slate grey
145 Volcano brown
156 Black
157 Graphite
164 Sage green

High-gloss lacquer

115 High-gloss Space grey
791 White high gloss
792 Magnolia white high gloss

Panel colours 25 mm

Matt

111 Light oak effect
120 Black
132 Slate grey
146 Black slate texture
147 Marble green
148 Jupiter sand
149 Copper slate texture
151 Marble white
160 Summerfield oak effect
165 Titian
166 Terra grey
517 White

165 Titian
166 Terra grey
517 White
648 Lava grey stone texture
674 Concrete effect, natural
683 Concrete effect, slate light grey
684 Concrete-effect slate dark grey
685 Carrara black
750 Magnolia white
780 Vintage oak effect
830 Graphite
840 Pebble grey
850 Havana oak effect
890 Oregon oak effect
900 Space grey
952 Petrol

167 White
168 Magnolia white
169 Pebble grey
171 Cappuccino
172 Space grey

924 High-gloss red
937 Pebble grey high gloss
939 Graphite high gloss

648 Lava grey stone texture
674 Concrete effect, natural
683 Concrete effect, slate light grey
684 Concrete effect, slate dark grey
750 Magnolia white
780 Vintage oak effect
830 Graphite
840 Pebble grey
850 Havana oak effect
890 Oregon oak effect
900 Space grey

Modular panels, Modular panels for base unit

Modular panel system 16 mm

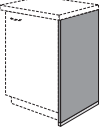
		width	universal
<p>Modular panels 16 mm thick with ABS edge on all sides <i>Colour version see panel colours 16 mm</i> The plinth height will be automatically calculated into the base unit, highboard and tall unit panels. The colour of the panel supports is chosen in the order header. Available panel support colours: 558 Stainless steel coloured 951 Black If no colour is stated with the order, delivery will be in 558 stainless steel coloured.</p>			
 <p>Modular panel for base unit Full width to the floor with panel shoe 585 mm depth</p>	723 mm high = carcass height plus plinth height Finish matt	WU 16	33
	723 mm high = carcass height plus plinth height Finish matt lacquer	WU 16 M	43
	723 mm high = carcass height plus plinth height Finish high-gloss	WU 16 HG	43
	723 mm high = carcass height plus plinth height Finish Colour Concept	WU 16 CKM	78
	867 mm high = carcass height plus plinth height Finish matt	WU 16 87	32
	867 mm high = carcass height plus plinth height Finish matt lacquer	WU 16 87 M	43
	867 mm high = carcass height plus plinth height Finish high-gloss	WU 16 87 HG	43
	867 mm high = carcass height plus plinth height Finish Colour Concept	WU 16 87 CKM	83

Modular panels for base unit

Modular panel system 16 mm

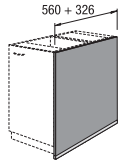

Panel for island plans
 floor-length with panel protector
 For carcass depth 560 + 326 mm

		width		universal
723 mm high = carcass height plus plinth height Finish matt	WU	16	93	46
723 mm high = carcass height plus plinth height Finish matt lacquer	WU	16	93 M	70
723 mm high = carcass height plus plinth height Finish high-gloss	WU	16	93 HG	70
723 mm high = carcass height plus plinth height Finish Colour Concept	WU	16	93 CKM	124
867 mm high = carcass height plus plinth height Finish matt	WU	16	93 87	50
867 mm high = carcass height plus plinth height Finish matt lacquer	WU	16	93 87M	80
867 mm high = carcass height plus plinth height Finish high-gloss	WU	16	93 87HG	80
867 mm high = carcass height plus plinth height Finish Colour Concept	WU	16	93 87CKM	154

Modular panels for base unit

Modular panel system 16 mm

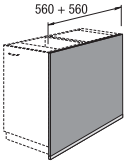
		width		universal
 <p>Panel for island plans floor-length with panel protector <i>For carcass depth 560 + 560 mm</i></p>	723 mm high = carcass height plus plinth height Finish matt	WU	16 117	51
	723 mm high = carcass height plus plinth height Finish matt lacquer	WU	16 117 M	86
	723 mm high = carcass height plus plinth height Finish high-gloss	WU	16 117 HG	86
	723 mm high = carcass height plus plinth height Finish Colour Concept	WU	16 117 CKM	167
	867 mm high = carcass height plus plinth height Finish matt	WU	16 117 87	59
	867 mm high = carcass height plus plinth height Finish matt lacquer	WU	16 117 87M	98
	Not available with plinth heights 155 and 205 mm			
	867 mm high = carcass height plus plinth height Finish high-gloss	WU	16 117 87HG	98
	Not available with plinth heights 155 and 205 mm			
	867 mm high = carcass height plus plinth height Finish Colour Concept	WU	16 117 87CKM	199

Modular panels for tall unit

Modular panel system 16 mm

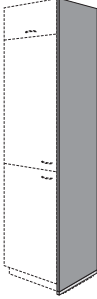
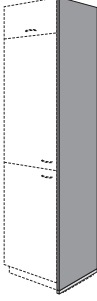
			width		universal
 <p>Modular panel for tall unit Full width to the floor with panel shoe 585 mm depth</p>	1907 mm high = carcass height (01) plus plinth height Finish matt	WS	16	01	68
	1907 mm high = carcass height (01) plus plinth height Finish matt lacquer	WS	16	01 M	95
	1907 mm high = carcass height (01) plus plinth height Finish high-gloss	WS	16	01 HG	95
	1907 mm high = carcass height (01) plus plinth height Finish Colour Concept	WS	16	01 CKM	167
	2051 mm high = carcass height (02) plus plinth height Finish matt	WS	16	02	71
	2051 mm high = carcass height (02) plus plinth height Finish matt lacquer	WS	16	02 M	101
	2051 mm high = carcass height (02) plus plinth height Finish high-gloss	WS	16	02 HG	101
	2051 mm high = carcass height (02) plus plinth height Finish Colour Concept	WS	16	02 CKM	177
 <p>Modular panel for tall unit Full width to the floor with panel shoe 585 mm depth</p>	2195 mm high = carcass height (03) plus plinth height Finish matt	WS	16	03	73
	2195 mm high = carcass height (03) plus plinth height Finish matt lacquer	WS	16	03 M	108
	2195 mm high = carcass height (03) plus plinth height Finish high-gloss	WS	16	03 HG	108
	2195 mm high = carcass height (03) plus plinth height Finish Colour Concept	WS	16	03 CKM	188

Modular panels for highboard

Modular panel system 16 mm

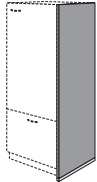
			width		universal	
 <p>Modular panel for highboard Full width to the floor with panel shoe 585 mm depth</p>	1043 mm high = carcass height plus plinth height Finish matt	WS	16	104	43	
	1043 mm high = carcass height plus plinth height Finish matt lacquer	WS	16	104	M	57
	1043 mm high = carcass height plus plinth height Finish high-gloss	WS	16	104	HG	57
	1043 mm high = carcass height plus plinth height Finish Colour Concept	WS	16	104	CKM	107
	1475 mm high = carcass height plus plinth height Finish matt	WS	16	148		57
	1475 mm high = carcass height plus plinth height Finish matt lacquer	WS	16	148	M	76
	1475 mm high = carcass height plus plinth height Finish high-gloss	WS	16	148	HG	76
	1475 mm high = carcass height plus plinth height Finish Colour Concept	WS	16	148	CKM	134
	1619 mm high = carcass height plus plinth height Finish matt	WS	16	162		60
	1619 mm high = carcass height plus plinth height Finish matt lacquer	WS	16	162	M	82
	1619 mm high = carcass height plus plinth height Finish high-gloss	WS	16	162	HG	82
	1619 mm high = carcass height plus plinth height Finish Colour Concept	WS	16	162	CKM	145

Modular panels for dresser unit

Modular panel system 16 mm

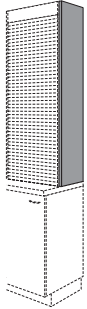



Modular panel for dresser unit

350 mm depth

		width		universal
1144 mm high = carcass height Finish matt	WA	16	01	23
1144 mm high = carcass height Finish matt lacquer	WA	16	01 M	40
1144 mm high = carcass height Finish high-gloss	WA	16	01 HG	40
1144 mm high = carcass height Finish Colour Concept	WA	16	01 CKM	71
1288 mm high = carcass height Finish matt	WA	16	02	24
1288 mm high = carcass height Finish matt lacquer	WA	16	02 M	42
1288 mm high = carcass height Finish high-gloss	WA	16	02 HG	42
1288 mm high = carcass height Finish Colour Concept	WA	16	02 CKM	78
1432 mm high = carcass height Finish matt	WA	16	03	25
1432 mm high = carcass height Finish matt lacquer	WA	16	03 M	45
1432 mm high = carcass height Finish high-gloss	WA	16	03 HG	45
1432 mm high = carcass height Finish Colour Concept	WA	16	03 CKM	85



Modular panels for wall unit

Modular panel system 16 mm

			width		universal
 <p>Modular panel for wall unit 350 mm depth</p>	291 mm high = carcass height Finish matt	WH	16	29	11
	291 mm high = carcass height Finish matt lacquer	WH	16	29	M 25
	291 mm high = carcass height Finish high-gloss	WH	16	29	HG 25
	291 mm high = carcass height Finish Colour Concept	WH	16	29	CKM 31
	363 mm high = carcass height Finish matt	WH	16	36	11
	363 mm high = carcass height Finish matt lacquer	WH	16	36	M 26
	363 mm high = carcass height Finish high-gloss	WH	16	36	HG 26
	363 mm high = carcass height Finish Colour Concept	WH	16	36	CKM 37
	579 mm high = carcass height (01) Finish matt	WH	16	01	13
	579 mm high = carcass height (01) Finish matt lacquer	WH	16	01	M 29
	579 mm high = carcass height (01) Finish high-gloss	WH	16	01	HG 29
	579 mm high = carcass height (01) Finish Colour Concept	WH	16	01	CKM 44
 <p>Modular panel for wall unit 350 mm depth</p>	723 mm high = carcass height (02) Finish matt	WH	16	02	14
	723 mm high = carcass height (02) Finish matt lacquer	WH	16	02	M 30
	723 mm high = carcass height (02) Finish high-gloss	WH	16	02	HG 30
	723 mm high = carcass height (02) Finish Colour Concept	WH	16	02	CKM 51
	867 mm high = carcass height (03) Finish matt	WH	16	03	17
	867 mm high = carcass height (03) Finish matt lacquer	WH	16	03	M 33
	867 mm high = carcass height (03) Finish high-gloss	WH	16	03	HG 33
	867 mm high = carcass height (03) Finish Colour Concept	WH	16	03	CKM 58

Modular shelves

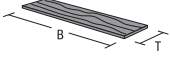
Modular panel system 16 mm

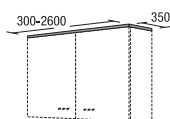
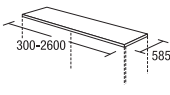
				width	universal
 <p>Modular panel in variable sizes grain direction horizontal</p> <p><i>Not suitable as a worktop replacement.</i></p> <p><i>Calculated per mm²</i> <i>Minimum size calculated = 0.5 m²</i></p>	<p>per m² Finish matt</p> <p>W: 250 - 2600 mm, D: 100 - 1185 mm</p>	WB	16	H	55
	<p>per m² Finish matt lacquer</p> <p>W: 250 - 2600 mm, D: 100 - 1010 mm</p>	WB	16	HM	75
	<p>per m² Finish high-gloss</p> <p>W: 250 - 2600 mm, D: 100 - 1010 mm</p>	WB	16	HHG	75
	<p>per m² Finish Colour Concept</p> <p>W: 250 - 2600 mm, D: 150 - 1185 mm</p>	WB	16	HCKM	154
 <p>Modular panel in variable sizes grain direction vertical</p> <p><i>Variable height 250 - 2600 mm</i> <i>Variable depth 100-1010 mm</i></p> <p><i>Not suitable as a worktop replacement.</i></p> <p><i>Calculated per mm²</i> <i>Minimum size calculated = 0.5 m²</i></p> <p><i>Panel shoe must be ordered separately.</i></p> <p><i>Size recommendation for carcass height panels of standard carcass depth (HxD):</i> <i>carcass height x 585 mm</i></p>	<p>per m² Finish matt</p> <p>H: 250 - 2600 mm, D: 100 - 1185 mm</p>	WB	16	V	55
	<p>per m² Finish matt lacquer</p> <p>H: 250 - 2600 mm, D: 100 - 1010 mm</p>	WB	16	VM	75
	<p>per m² Finish high-gloss</p> <p>H: 250 - 2600 mm, D: 100 - 1010 mm</p>	WB	16	VHG	75
	<p>per m² Finish Colour Concept</p> <p>H: 250 - 2600 mm, D: 150 - 1185 mm</p>	WB	16	VCKM	154
 <p>Top panel for wall unit 350 mm depth</p> <p><i>Calculated per mm</i></p>	<p>per metre Finish matt</p>	WB	16	350	21
 <p>Top panel for highboard / tall unit 585 mm depth</p> <p><i>Not suitable as a worktop replacement.</i></p> <p><i>Calculated per mm</i></p>	<p>per metre Finish matt</p>	WB	16	585	27

Modular shelves, Accessories

Modular panel system 16 mm

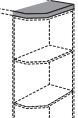
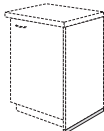
		width		universal	
 <p>Top panel with angled cut for highboard / tall unit Left or right chamfered edge</p> <p>585 mm deep max. 2600 mm wide Slope = hinge side</p> <p>An overhang of 25 mm must be taken into account at the side for end shelf units and 3-D units.</p> <p>Calculated per mm</p>	Per metre started For shelf end unit Finish matt	WBS	16	585A	52
	Per metre started For diagonal unit Finish matt	WBS	16	585V	52
	Per metre started For shelf end unit Finish matt	WBS	16	585AA	78
	Per metre started For diagonal unit Finish matt	WBS	16	585VV	78
	per metre Finish matt	WBS	16	585AV	78
<p>Top panel with angled cut for highboard / tall unit Left and right chamfered edge</p> <p>585 mm deep max. 2600 mm wide</p> <p>An overhang of 25 mm must be taken into account on each side for end shelf units and 3-D units.</p> <p>Calculated per mm</p>	per metre Finish matt	WBS	16	585VA	78
<p>Top panel with angled cut for highboard / tall unit 3-D unit left, end shelf unit right</p> <p>585 mm deep max. 2600 mm wide</p> <p>An overhang of 25 mm must be taken into account on each side for end shelf units and 3-D units.</p> <p>Calculated per mm</p>	per metre Finish matt	WBS	16	585VA	78
<p>Top panel for highboard / tall unit 585 mm depth</p> <p>Not suitable as a worktop replacement.</p>	Finish matt	WB16585	30		8
	Finish matt	WB16585	60		16
	Finish matt	WB16585	90		24
	Finish matt	WB16585	120		32
	Finish matt	WB16585	150		40
 <p>Panel shoe for 16 mm thick modular panels</p> <p>The end cap of the panel shoe must be ordered separately for freestanding solutions / island solutions.</p>	585 mm deep	WASCH	16	585	5
	885 mm deep	WASCH	16	885	7
	1200 mm deep	WASCH	16	1200	9
		WASCH	16	EK	1
<p>End cap for panel shoe for 16 mm panel shoes</p> <p>For free-standing / island solutions.</p>					

Modular panels, Modular panels for base unit, Modular panels for tall unit

Modular panel system 25 mm

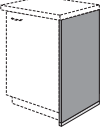
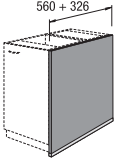
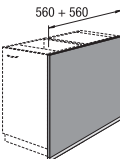
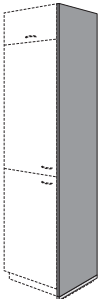
		width		universal	
<p>Modular panels 25 mm thick with ABS edge on all sides <i>Colour version see panel colours 25 mm</i> The plinth height will be automatically calculated into the base unit, highboard and tall unit panels. The colour of the panel supports is chosen in the order header. Available panel support colours: 558 Stainless steel coloured 951 Black If no colour is stated with the order, delivery will be in 558 stainless steel coloured.</p>					
	<p>Modular panel for base unit Full width to the floor with panel shoe 585 mm depth</p>	723 mm high = carcass height plus plinth height Finish matt	WU	25	42
		867 mm high = carcass height plus plinth height Finish matt	WU	25 87	46
	<p>Panel for island plans floor-length with panel protector For carcass depth 560 + 326 mm</p>	723 mm high = carcass height plus plinth height Finish matt	WU	25 93	51
		867 mm high = carcass height plus plinth height Finish matt	WU	25 93 87	55
	<p>Panel for island plans floor-length with panel protector For carcass depth 560 + 560 mm</p>	723 mm high = carcass height plus plinth height Finish matt	WU	25 117	57
		867 mm high = carcass height plus plinth height Finish matt	WU	25 117 87	65
	<p>Modular panel for tall unit Full width to the floor with panel shoe 585 mm depth</p>	1907 mm high = carcass height (01) plus plinth height Finish matt	WS	25 01	70
		2051 mm high = carcass height (02) plus plinth height Finish matt	WS	25 02	73
		2195 mm high = carcass height (03) plus plinth height Finish matt	WS	25 03	75

Modular panels for highboard, Modular panels for dresser unit, Modular panels for wall unit, Modular shelves

Modular panel system 25 mm

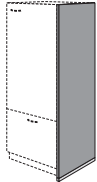
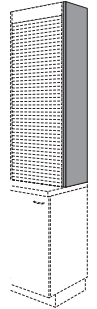
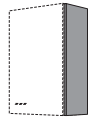
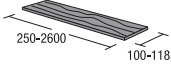
			width	universal
 <p>Modular panel for highboard Full width to the floor with panel shoe 585 mm depth</p>	1043 mm high = carcass height plus plinth height Finish matt	WS	25 104	53
	1475 mm high = carcass height plus plinth height Finish matt	WS	25 148	66
	1619 mm high = carcass height plus plinth height Finish matt	WS	25 162	72
 <p>Modular panel for dresser unit 350 mm depth</p>	1144 mm high = carcass height Finish matt	WA	25 01	30
	1288 mm high = carcass height Finish matt	WA	25 02	31
	1432 mm high = carcass height Finish matt	WA	25 03	30
 <p>Modular panel for wall unit 350 mm depth</p>	291 mm high = carcass height Finish matt	WH	25 29	16
	363 mm high = carcass height Finish matt	WH	25 36	18
	579 mm high = carcass height (01) Finish matt	WH	25 01	24
	723 mm high = carcass height (02) Finish matt	WH	25 02	25
	867 mm high = carcass height (03) Finish matt	WH	25 03	27
 <p>Modular panel in variable sizes grain direction horizontal Per m² Finish matt</p> <p>Variable width 250 - 2600 mm Variable depth 100-1185 mm</p> <p><i>Not suitable as a worktop replacement.</i></p> <p>Calculated per mm² Minimum size calculated = 0.5 m²</p>		WB	25 H	81

Modular shelves

Modular panel system 25 mm

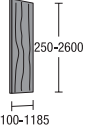
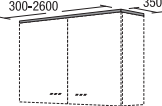
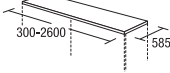
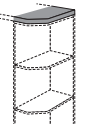
			width			universal
 <p>Modular panel in variable sizes grain direction vertical Variable height 250 - 2600 mm Variable depth 100-1185 mm Not suitable as a worktop replacement. Calculated per mm² Minimum size calculated = 0.5 m² Panel shoe must be ordered separately. Size recommendation for carcass height panels of standard carcass depth (HxD): carcass height x 585 mm</p>	Per m ² Finish matt	WB	25	V		81
 <p>Top panel for wall unit grain direction horizontal 350 mm depth Calculated per mm</p>	Per metre started Finish matt	WB		25 350		26
 <p>Top panel for highboard / tall unit grain direction horizontal 585 mm depth Not suitable as a worktop replacement. Calculated per mm</p>	Per metre started Finish matt	WB		25 585		32
 <p>Top panel with angled cut for highboard / tall unit Left or right chamfered edge 585 mm depth max. width 2600 mm Angled side = hinge For end shelf units and 3-D units, take account of a lateral projection of 25 mm. Calculated per mm</p>	Per metre started For shelf end unit Finish matt	WBS		25 585A		55
	Per metre started For diagonal unit Finish matt	WBS		25 585V		55
<p>Top panel with angled cut for highboard / tall unit Left and right chamfered edge 585 mm depth max. width 2600 mm For end shelf units and 3-D units, take account of a lateral projection of 25 mm. Calculated per mm</p>	Per metre started For shelf end unit Finish matt	WBS		25 585AA		81
	Per metre started For diagonal unit Finish matt	WBS		25 585W		81

Modular shelves, Edging material, Accessories

Modular panel system 25 mm

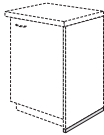
			width	universal	
<p>Top panel with angled cut for highboard / tall unit End shelf unit left, diagonal unit right</p> <p><i>585 mm depth max. width 2600 mm</i></p> <p><i>For end shelf units and 3-D units, take account of a lateral projection of 25 mm.</i></p> <p><i>Calculated per mm</i></p>	Per metre started Finish matt	WBS	25	585AV	81
<p>Top panel with angled cut for highboard / tall unit 3-D unit left, end shelf unit right</p> <p><i>585 mm depth max. width 2600 mm</i></p> <p><i>For end shelf units and 3-D units, take account of a lateral projection of 25 mm.</i></p> <p><i>Calculated per mm</i></p>	Per metre started Finish matt	WBS	25	585VA	81
<p>Modular panel edge in all panel finishes with thick edge without hot-melt adhesive</p> <p><i>Calculated per mm</i></p>	per metre	WK	25		2
 <p>Panel shoe for 25 mm thick modular panels</p> <p><i>The end cap of the panel shoe must be ordered separately for freestanding solutions / island solutions.</i></p> <p>End cap for panel shoe for 25 mm panel shoes</p> <p><i>For free-standing / island solutions.</i></p>	585 mm deep	WASCH	25	585	6
	885 mm deep	WASCH	25	885	8
	1200 mm deep	WASCH	25	1200	10
		WASCH	25	EK	1

Shelves

Niche elements

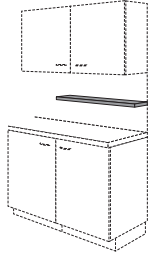

Shelf

25 mm thick, 190 mm deep
lamine edge,
two invisible supports for wall fitting
(Not suitable for plasterboard walls)

Max. load bearing per support 7 kg

Finish in carcass material

Light slots not possible



Available in all 25 mm panel colours

Calculated per 10 mm

per metre
300 - 2600 mm

	width		universal
BR	30	25	18
BR	40	25	19
BR	45	25	19
BR	50	25	20
BR	60	25	21
BR	65	25	22
BR	70	25	24
BR	80	25	26
BR	90	25	26
BR	100	25	28
BR	120	25	34
BR	V	25	54

Shelf accessories

			width	Item	universal
	<p>Shelf supports for shelves, glass shelves and cover panels</p> <p>2 items in set</p> <p><i>One set is necessary for each 750 mm started.</i></p> <p><i>adjustable for materials from 8 mm to 50 mm</i> <i>max. shelf depth 320 mm</i> <i>maximum safe load 8 kg each, incl. shelf weight</i></p>	stainless steel-effect	30	ZN 850 E	6
		Black finely textured	30	ZN 850 S	6
					
	<p>Shelf supports for shelves, glass shelves and cover panels</p> <p>2 items in set</p> <p><i>One set is necessary for each 750 mm started.</i></p> <p><i>Adjustable for material thicknesses from 8 mm to 40 mm</i> <i>Maximum pull-out shelf depth 320 mm</i> <i>Total loading capacity per carrier 20 kg (incl. shelf width)</i> <i>Depth of shelf support: 180 mm</i></p>	stainless steel-effect	24	ZN 18 E	8
		Black finely textured	24	ZN 18 S	7

Back panel

			width	universal
<p>Carcase material without edges, 16 mm thick</p> <p>in all carcase colours in exterior finish on both sides, additionally in visible additional item colours</p> <p><i>Available dimensions:</i> Height: 150 - 2600 mm Width: 150 - 2050 mm</p> <p><i>Not available in visible side colours.</i></p> <p><i>Calculated per mm²</i> <i>Minimum size calculated = 0.5 m²</i></p>	per m ²	KBO		35
 <p>Carcase material with thin edge, 16 mm thick</p> <p>grain direction vertical in all carcase colours in exterior finish on both sides, additionally in visible additional item colours</p> <p><i>Available dimensions:</i> high: 250 - 2600 mm wide: 100 - 560 mm</p> <p><i>Not available in visible side colours.</i></p> <p><i>Please note that for edge joins, the finishes are not continuous, but are offset.</i></p> <p><i>Calculated per mm²</i> <i>Minimum size calculated = 0.5 m²</i></p>	per m ²	KBMM		42
 <p>Carcase material / back panelling with thick edge, 16 mm thick</p> <p>grain direction vertical in all carcase colours in exterior finish on both sides, additionally in visible additional item colours</p> <p><i>Available dimensions:</i> high: 250 - 2600 mm wide: 100 - 2050 mm</p> <p><i>Not available in visible side colours.</i></p> <p><i>Fastening supplies Z 670 or MZ KBM RW must be ordered separately.</i> <i>An anti-tilt device is needed for room divider versions.</i> <i>Please note that for edge joins, the finishes are not continuous, but are offset.</i></p> <p><i>Calculated per mm²</i> <i>Minimum size calculated = 0.5 m²</i></p>	per m ²	KBM	V	42

Back panel

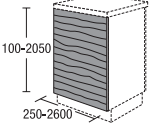
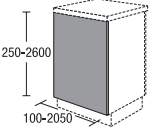
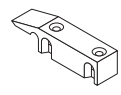
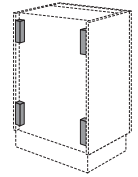
			width	universal
 <p>Carcase material / back panelling with thick edge, 16 mm thick</p> <p>per m²</p> <p>grain direction horizontal in all carcasse colours in exterior finish on both sides, additionally in visible additional item colours</p> <p><i>Available dimensions: high: 100 - 2050 mm wide: 250 - 2600 mm</i></p> <p><i>Not available in visible side colours.</i></p> <p><i>Fastening supplies Z 670 or MZ KBM RW must be ordered separately. An anti-tilt device is needed for room divider versions. Please note that for edge joins, the finishes are not continuous, but are offset.</i></p> <p><i>Calculated per mm² Minimum size calculated = 0.5 m²</i></p>		KBM	H	42
 <p>Back panelling same as door material</p> <p>per m²</p> <p>CF colours 16 mm thick with edge in matching colour</p> <p><i>Available dimensions: wide: 100 - 2050 mm high: 250 - 2600 mm</i></p> <p><i>Fastening supplies Z 670 or MZ KBM RW must be ordered separately.</i></p> <p><i>An anti-tilt device is needed for room divider versions.</i></p> <p><i>Calculated per mm² Minimum size calculated = 0.5 m²</i></p> <p><i>Available finishes: 112 Cappuccino 121 Thyme 133 Volcano brown 134 Alby Blue 158 Sage green 952 Petrol</i></p>		FM	V	50
 <p>Clip fitting for back wall cladding</p> <p>2 pairs</p>		Z670		3
 <p>Fitting accessories for back wall covering</p> <p>4-piece set</p>		MZKBMRW		4

Notes

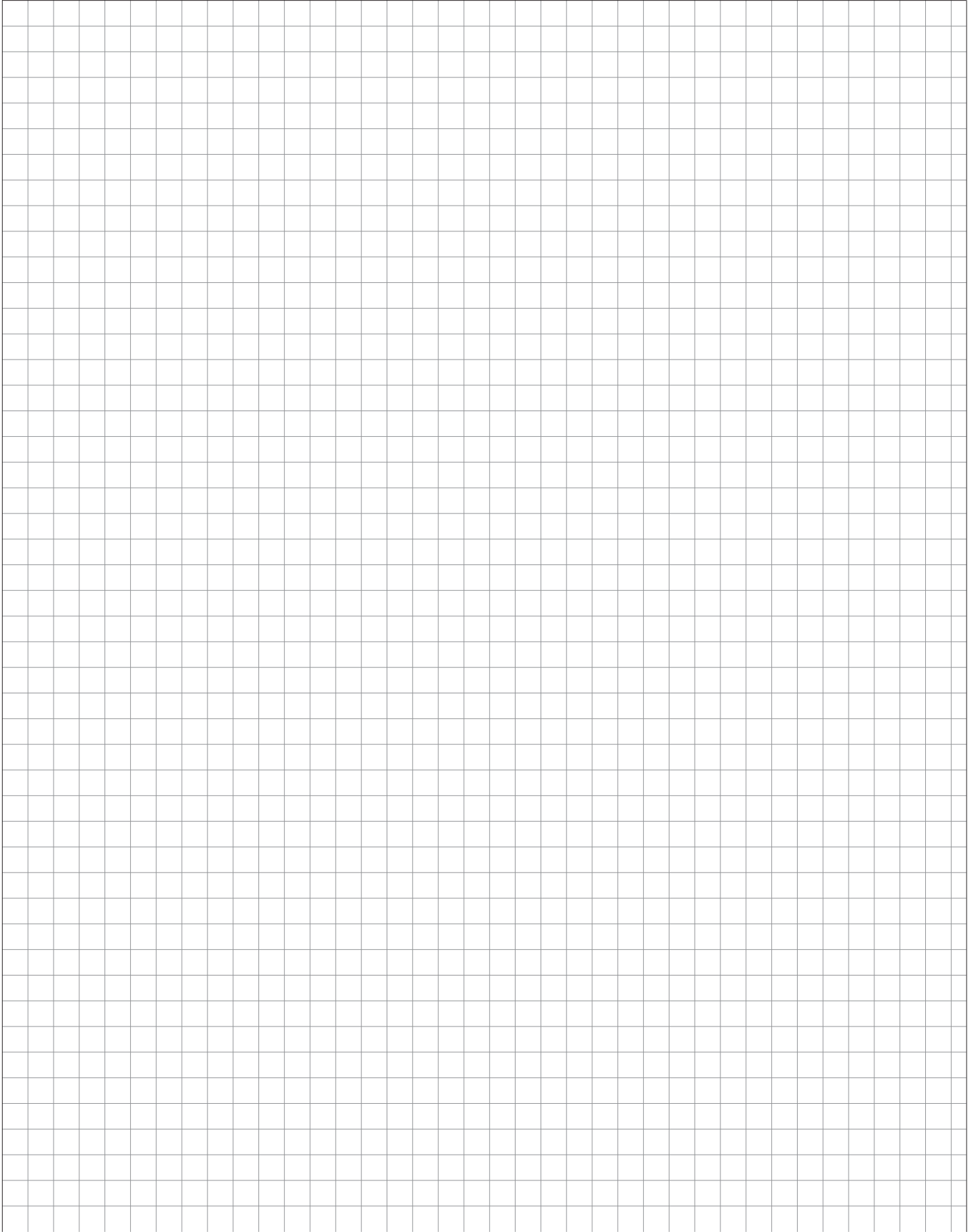

7. Worktops, niches

Worktops
Sealer strips
Niche back panels
Glass niche back panel
Worktop/breakfast bar/niche accessories

7. Worktops, niches



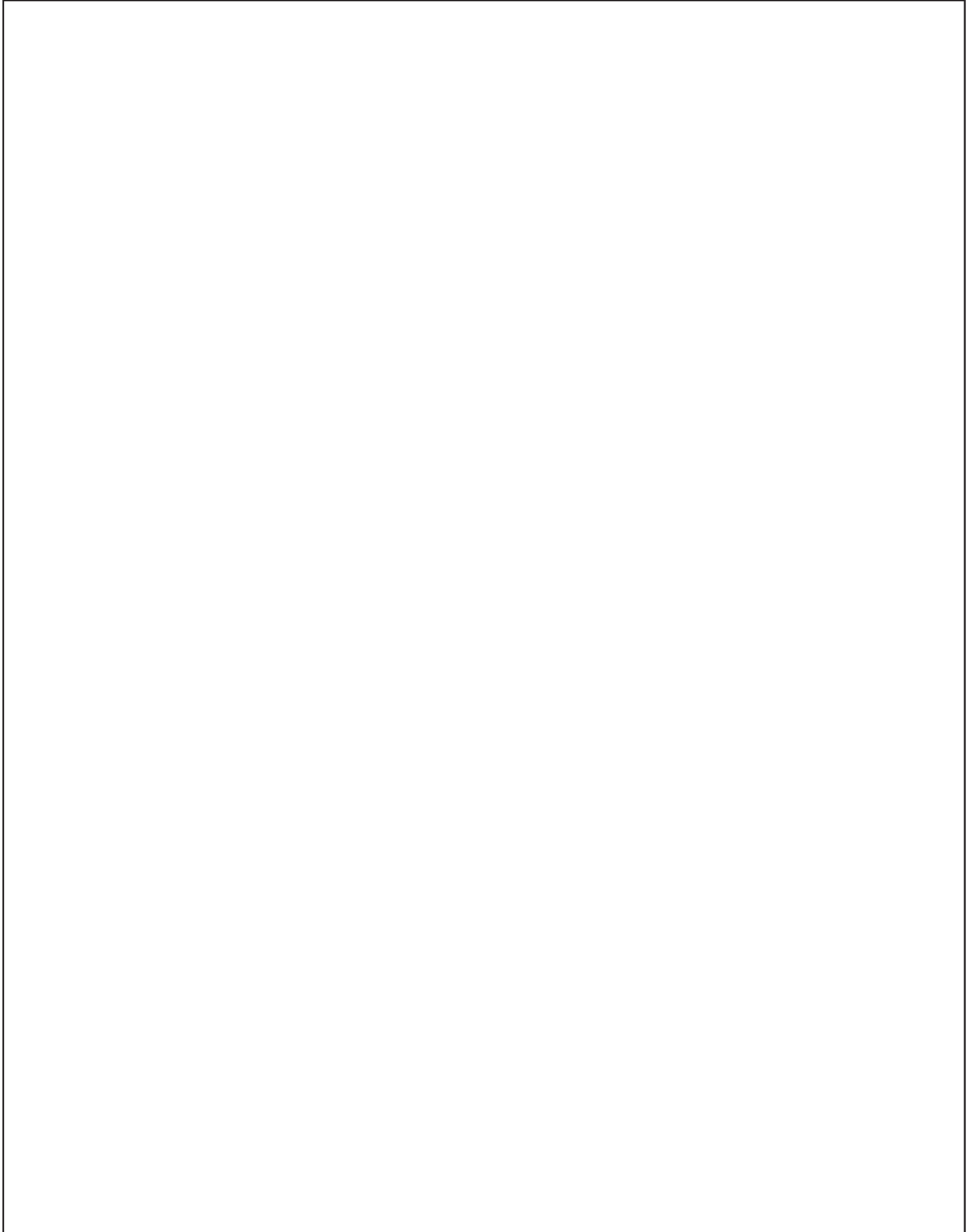

Worktops, sealer strips





PLR worktops

approx. 40 mm thick

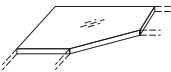

			width	universal
 <p>Worktop D-Profile</p> <p>Worktop approx. 40 mm thick, with rounded front edge, both sides with edging in same finish as surface. Max. length 4000 mm, min. length/depth 250 mm</p> <p><i>Colour finish see Worktop summary</i></p> <p><i>For reasons of manufacturing technology, worktops can only be manufactured from a length and/or depth of 250 mm upwards.</i></p> <p><i>Price per 100 mm or part thereof</i></p>	600 mm deep / per metre	PLR60	36	
	700 mm deep / per metre	PLR70	51	
	800 mm deep / per metre	PLR80	61	
	900 mm deep / per metre	PLR90	75	
	1200 mm deep / per linear metre	PLR120	95	
 <p>Corner worktop 750 mm deep, for corner 1050 x 1050 mm</p> <p>for installing a 600 mm wide base unit with 600 mm joints on both sides. Corner dimensions: 1050 x 1050 mm, 750 mm deep</p> <p><i>Dimensions and connectors cannot be altered</i></p> <p>Corner worktop Variable</p> <p>for fitting a base unit with joints on both sides / edges</p> <p><i>corner sizes / joint / edges variable</i></p>		PLR105	74	
		PLRECKE	169	
 <p>Corner worktop 1167 mm deep, for corner 1050 x 1050 mm</p> <p>for installing a 600 mm wide base unit with 600 mm joints on both sides. Corner dimensions: 1050 x 1050 mm, 1167 mm deep</p> <p><i>Dimensions and connectors cannot be altered</i></p> <p>Corner worktop 1061 mm deep, for corner 900 x 900 mm</p> <p>for installing a 400 mm wide base unit with 600 mm joints on both sides. Corner dimensions: 900 x 900 mm, 1061 mm deep</p> <p><i>Dimensions and connectors cannot be altered</i></p> <p>Corner worktop Variable</p> <p>for fitting a base unit with joints on both sides / edges</p> <p><i>corner sizes / joint / edges variable</i></p> <p><i>With an overall depth of 1200 mm and above, the top consists of two parts that must be installed on site</i></p>		PLR10560	110	
		PLR439060	100	
		PLRECKE60	210	

Standard corner joints are included in the price of the worktops:
Joints in 90° range, for corner worktops, set-forward units or worktop extensions.

7.01

PLS worktops

approx. 40 mm thick

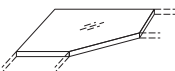
			width	universal	
 <p>Worktop Panel approx. 40 mm thick, with straight front edge, one lengthways edge and both side edges finished in the same decor as the worktop surface. Max. length 4000 mm, min. length / depth 250 mm</p> <p>Laminate surface finish Edges 1.0 mm PP</p> <p><i>Colour finish see Worktop summary</i></p> <p><i>Standard finish worktop edge same as surface</i></p> <p><i>Edge finish available in all worktop surface colours.</i></p> <p><i>For reasons of manufacturing technology, worktops can only be manufactured from a length and/or depth of 250 mm upwards.</i></p> <p><i>Price per 100 mm or part thereof</i></p>	600 mm deep / per metre	PLS60		36	
	700 mm deep / per metre	PLS70		51	
	800 mm deep / per metre	PLS80		61	
	900 mm deep / per metre	PLS90		75	
	1197 mm deep / per linear metre	PLS120		95	
 <p>Corner worktop 750 mm deep, for corner 1050 x 1050 mm for installing a 600 mm wide base unit with 600 mm joints on both sides. Corner dimensions: 1050 x 1050 mm, 750 mm deep</p> <p><i>Dimensions and connectors cannot be altered</i></p>		PLS105		74	
	<p>Corner worktop Variable for fitting a base unit with joints on both sides / edges</p> <p><i>corner sizes / joint / edges variable</i></p>		PLSECKE		169
 <p>Corner worktop 1167 mm deep, for corner 1050 x 1050 mm for installing a 600 mm wide base unit with 600 mm joints on both sides. Corner dimensions: 1050 x 1050 mm, 1167 mm deep</p> <p><i>Dimensions and connectors cannot be altered</i></p>		PLS10560		110	
	<p>Corner worktop 1061 mm deep, for corner 900 x 900 mm for installing a 400 mm wide base unit with 600 mm joints on both sides. Corner dimensions: 900 x 900 mm, 1061 mm deep</p> <p><i>Dimensions and connectors cannot be altered</i></p>		PLS439060		100
	<p>Corner worktop Variable for fitting a base unit with joints on both sides / edges</p> <p><i>corner sizes / joint / edges variable</i></p> <p><i>With an overall depth of 1197 mm and above, the top consists of two parts that must be installed on site</i></p>		PLSECKE60		210

7.02

Standard corner joints are included in the price of the worktops:
Joints in 90° range, for corner worktops, set-forward units or worktop extensions.

PLS worktops

approx. 40 mm thick

		width	universal
<p>Worktop</p> <p>Panel approx. 40 mm thick Horizontal edges and both short edges with same decor edging as surface Depth 600 mm</p> <p><i>Colour finish see Worktop summary</i></p> <p><i>Standard finish worktop edge same as surface</i></p>	PLS4060	30	12
	PLS4060	40	17
	PLS4060	45	21
	PLS4060	50	21
	PLS4060	60	25
	PLS4060	70	30
	PLS4060	80	34
	PLS4060	90	38
	PLS4060	100	43
	PLS4060	110	47
	PLS4060	120	51
	PLS4060	130	55
	PLS4060	140	60
	PLS4060	150	64
	PLS4060	160	68
	PLS4060	170	73
	PLS4060	180	77
	PLS4060	190	81
	PLS4060	200	86
	PLS4060	210	90
	PLS4060	220	94
	PLS4060	230	98
	PLS4060	240	103
	PLS4060	250	107
	PLS4060	260	111
	PLS4060	270	116
	PLS4060	280	120
	PLS4060	290	124
	PLS4060	300	129

Standard corner joints are included in the price of the worktops:
Joints in 90° range, for corner worktops, set-forward units or worktop extensions.

7.03

Planning advice worktops 25 mm

General:

- Surface: laminate, front and side edging with thick edge if desired
- Shelf thickness: approx. 25 mm
- Available decors see Overview of worktops
- Only worktop edge PLS possible
- The use of different materials may result in variations between the colour of the worktop and of the edging

Planning advice:

The 25 mm thick worktop cannot be combined with the following cabinets:

- Top-mounted units adjoining wall or tall units with a continuous top edge line
- Recess shelves under wall units

Planning advice cooker units:

- Cut-outs for the hob are to be undertaken on-site
- It is not possible to flush-mount the hob
- The various manufacturers' assembly instructions must be observed
- Please state the appliance type of the hob when ordering
- The corresponding attachment claws for 25 mm worktops are suitable for hobs provided by us
- The undermounting strips for hobs (third-party appliances) must be included in the order if required (item MZAPL25)

Planning advice dishwashers:

- The base unit sides in the cut-out may have to be notched in the area of the sink attachment
- Dishwashers with a sink drainer above have to be lowered for installation. The required plinth height is at least 115 mm, or 165 mm for XXL appliances
- The dishwasher has to be shifted downwards by 16 mm in order to fit an infill
- On lowered appliances, infill ZVD 60 16 is to be ordered separately
- The various manufacturers' assembly instructions must be observed
- Please state the appliance type when ordering

Planning advice sink base units:

- The corresponding attachment claws for 25 mm worktops are suitable for granite sinks provided by us
- The attachment materials (item MZAPL25) for stainless sinks provided by us need to be ordered for each consignment
- Cut-outs for the built-in sinks are to be undertaken on-site
- It is not possible to flush-mount built-in sinks
- The various manufacturer's assembly instructions must be observed
- Required sink unit base: sink cut-out plus 65 mm
- Please state the sink type when ordering

PLS worktops

approx. 25 mm thick

			width	universal	
 <p>Worktop Panel approx. 25 mm thick, with straight front edge, one lengthways edge and both side edges finished in the same decor as the worktop surface. Max. length 4000 mm, min. length / depth 250 mm</p> <p>Laminate surface finish Edges 1.0 mm PP</p> <p><i>Colour finish see Worktop summary</i></p> <p><i>Standard finish worktop edge same as surface</i></p> <p><i>Edge finish available in all worktop surface colours.</i></p> <p><i>For reasons of manufacturing technology, worktops can only be manufactured from a length and/or depth of 250 mm upwards.</i></p> <p><i>Price per 100 mm or part thereof</i></p>	600 mm deep / per metre	PLS2560		40	
	700 mm deep / per metre	PLS2570		62	
	800 mm deep / per metre	PLS2580		71	
	900 mm deep / per metre	PLS2590		84	
	1200 mm deep / per linear metre	PLS25120		102	
 <p>Corner worktop 750 mm deep, for corner 1050 x 1050 mm for installing a 600 mm wide base unit with 600 mm joints on both sides. Corner dimensions: 1050 x 1050 mm, 750 mm deep</p> <p><i>Dimensions and connectors cannot be altered</i></p>		PLS25105		92	
	<p>Corner worktop Variable for fitting a base unit with joints on both sides / edges</p> <p><i>corner sizes / joint / edges variable</i></p>		PLS25ECKE		187
 <p>Corner worktop 1167 mm deep, for corner 1050 x 1050 mm for installing a 600 mm wide base unit with 600 mm joints on both sides. Corner dimensions: 1050 x 1050 mm, 1167 mm deep</p> <p><i>Dimensions and connectors cannot be altered</i></p>		PLS2510560		128	
	<p>Corner worktop 1061 mm deep, for corner 900 x 900 mm for installing a 400 mm wide base unit with 600 mm joints on both sides. Corner dimensions: 900 x 900 mm, 1061 mm deep</p> <p><i>Dimensions and connectors cannot be altered</i></p>		PLS25439060		118
	<p>Corner worktop Variable for fitting a base unit with joints on both sides / edges</p> <p><i>corner sizes / joint / edges variable</i></p> <p><i>With an overall depth of 1197 mm and above, the top consists of two parts that must be installed on site</i></p>		PLS25ECKE60		228

Standard corner joints are included in the price of the worktops:
Joints in 90° range, for corner worktops, set-forward units or worktop extensions.

7.05

PLS worktops

approx. 25 mm thick

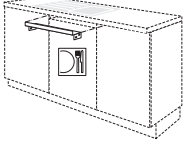
		width	universal
 <p>Distance strip for lowered electrical appliances Powder-coated metal silver-grey</p>	ZVD 60 16		4
<p>Installation set for sinks / hobs with 25 mm worktops 3 undermounting strips in set, 16 x 12 mm Length: 840 mm</p>	MZAPL25		13

7.06

Standard corner joints are included in the price of the worktops:
Joints in 90° range, for corner worktops, set-forward units or worktop extensions.

Calculating fixed tables and 3-D worktops

The PLS worktop prices are used as a basis for calculating fixed tables. Plus surcharges for edging strips on back, curves, angled and corner cut-outs.

Support leg and accessories for worktops can be found in the following sub-register Accessories for worktops/counters/niches.

The maximum dimensions for table attachments (900 x 1600 mm) are not to be exceeded.

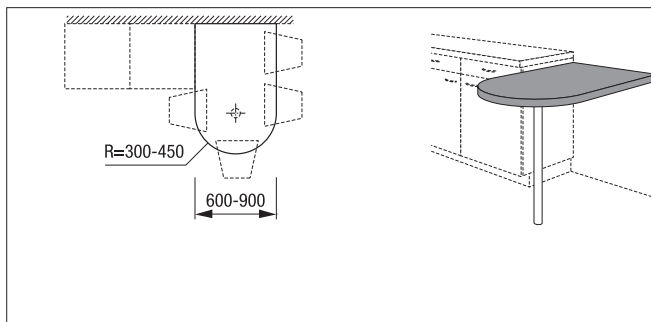

Fixed table with semicircular curvature

Example shown is PLS version
 1 PLS worktop (length x depth)
 1 rear side with PLS edge (AUS 5600)
 1 semicircular curvature (AUS 9000)

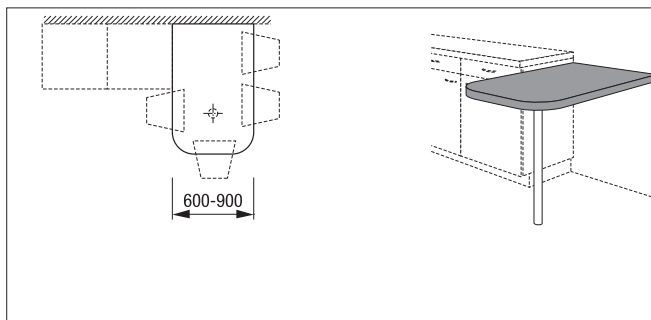

Fixed table with rounded corners

Example shown with PLS version
 1 PLS worktop (length x depth)
 1 rear side with PLS edge (AUS 5600)
 2 rounded corners for PLS (2 x AUS 7000)

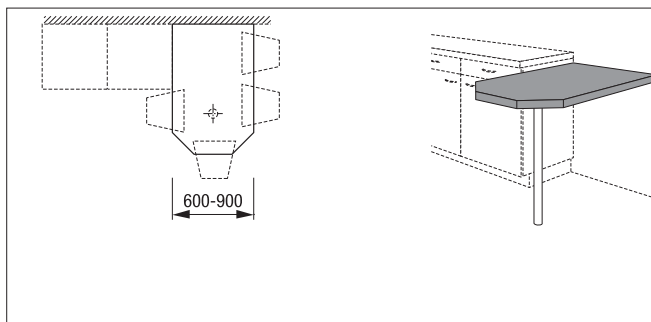

Fixed table with angled corners

Example shown is PLS version
 1 PLS worktop (length x depth)
 1 rear side with PLS edge (AUS 5600)
 2 angled corners with PLS edge (2 x AUS 3000)

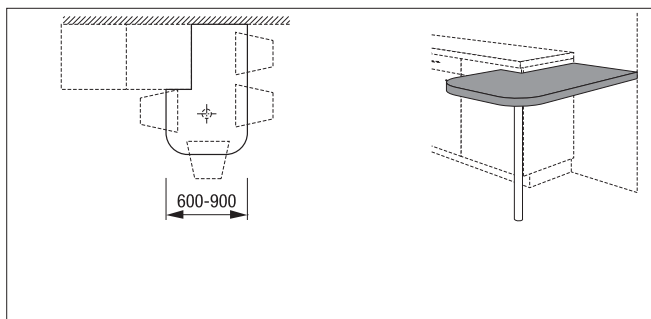

Fixed table with rounded corners and corner cut out

Example shown is PLS version
 1 PLS worktop (length x depth)
 1 rear side with PLS edge (AUS 5600)
 2 rounded corners for PLS (2 x AUS 7000)
 1 corner cut out according to sketch with PLS edge (AUS 4000)

Calculating fixed tables and 3-D worktops

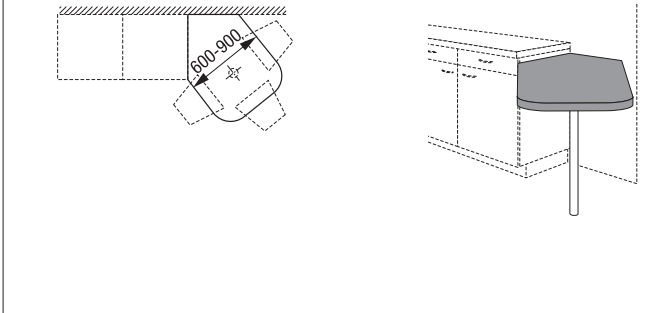

Fixed table with rounded corners and angled cut

- Example shown is PLS version
- 1 PLS worktop (length x depth)
 - 1 rear side with PLS edge (AUS 5600)
 - 2 rounded corners for PLS (2 x AUS 7000)
 - 2 angled cuts according to sketch with PLS edge (2 x AUS 3000)

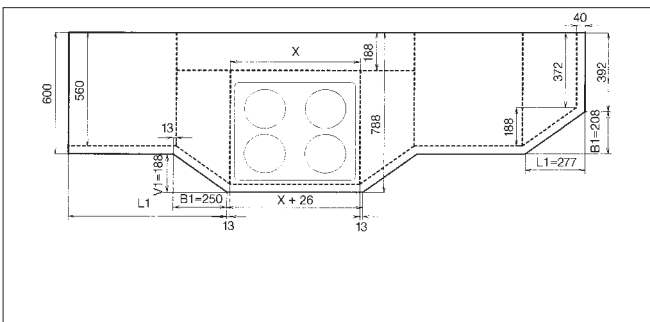

Diagonal worktop

- Example shows PLS option
- 1 worktop, PLS (length x depth)
 - 2 corner cut-outs with edging strip PLS (2 x AUS 4000)
 - 1 angled cut with edging PLS (AUS 3000)



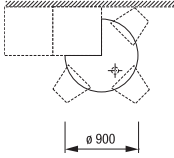
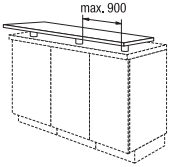
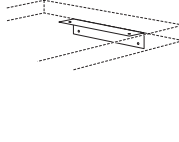

Worktops

		width	universal
 <p>Surcharge for round fixed table top diameter 600-900 mm <i>Example in addition 1 x AUS 4000</i> <i>Order worktop separately.</i></p>		AUS9900	56
 <p>Breakfast bar 500 mm deep Panel approx. 40 mm thick in conjunction with brackets with ABS edge on all sides <i>surface and edge finish refer to Worktops</i> <i>Breakfast bar cannot be modified in depth and shape.</i> <i>Order support for breakfast bar separately.</i> <i>See accessories</i> <i>In case of modifications, order PLS 60 with the corresponding cutouts</i> <i>The maximum gap between the consoles of 900 mm must not be exceeded.</i> <i>The information in the instructions for mounting the brackets must be observed without fail.</i> <i>Price per 100 mm or part thereof</i></p>	per metre	PLS50	38
 <p>Bracket for attaching the worktop to the wall including screws and dowels Length: 250 mm, angle 40 x 40 mm</p>		MZAPLWI	6

Standard corner joints are included in the price of the worktops:
 Joints in 90° range, for corner worktops, set-forward units or worktop extensions.

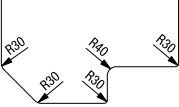
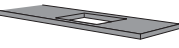
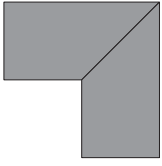
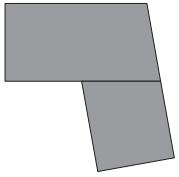





7.09

Surcharges for worktops and material prices

		width	universal
<p>Note: The worktop overhang to the carcass for the strip handle versions nos. 760 and 800, and for the front panels with integrated recessed grip, is just 30 mm instead of 40 mm.</p>			
<p>Rounding off We reserve the right to round off corners outside by 30 mm and inside by 40 mm for cutouts and angled cuts.</p> 			
<p>Surcharge for pre-routing cutout for built-in sinks and hobs per pre-routed cutout <i>Cutouts must be sealed by the customer.</i> <i>Worktop cutouts can be provided for all rectangular sinks and hobs. Specify cutout size.</i> <i>Not available for worktop thickness 25 mm</i></p> 	AUS1000		6
<p>Surcharge Worktop corner joint, mitred per worktop</p> 	AUS3500		12
<p>Surcharge Worktop corner joint Possible room angle 70° to 110° Supplement per worktop <i>Possible solid angle 70° to 110°</i></p> 	AUS3600		12
<p>Surcharge Angled cut with ABS edge Front side coated with straight edge per angled cut <i>Minimum angling: 40 x 40 mm</i></p> 	AUS3000		12
<p>Surcharge Rounded corner acc. to sketch per rounding <i>Minimum radius: 30 mm</i></p> 	AUS7000		14
<p>Supplement PLR worktop with slanted cut Angle and front edge with PLR edge</p> 	<p>per angled cut for end shelf units</p> <p>One angled cut per diagonal unit at the end of the row</p> <p>Angled cut variable Minimum angled cut: 100 x 100 mm</p>	<p>AUS7700</p> <p>AUS7800</p> <p>AUS7900</p>	<p>61</p> <p>61</p> <p>74</p>

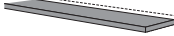
7.10 Standard corner joints are included in the price of the worktops:
Joints in 90° range, for corner worktops, set-forward units or worktop extensions.

Surcharges for worktops and material prices

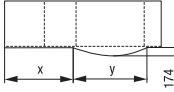
		width	universal
 <p>Semicircular rounding acc. to drawing</p>		AUS9000	28
 <p>Surcharge PLR edge on right/left side per side <i>Possible with a worktop projection of 20 mm or more.</i></p>		AUS7500	22
 <p>Surcharge Worktop depth reduction per item</p>		AUS5500	5
 <p>Surcharge Worktop with ABS edge at the back per metre edge <i>Calculated per mm</i></p>		AUS5600	7
 <p>Surcharge Corner cut-out with ABS edge per item <i>Minimum corner cutout: 40 x 40 mm</i></p>		AUS4000	15
 <p>Surcharge Corner cut-out without edge per item <i>Minimum corner cutout: 40 x 40 mm</i></p>		AUS4100	9
 <p>Surcharge PLS worktop with rounded front edge per metre <i>For 900 mm wide base units with a curved front, the width of the rounding is approx. 1000 mm</i> <i>Calculated per mm</i></p> <p>x = length y = width</p>		AUS6720	20
<p>Surcharge for special worktops Surcharge for all special worktop shapes not illustrated in this catalogue. <i>The desired worktop shape must be checked for feasibility before confirmation.</i></p>		AUSSOND	127
<p>Straight worktop edge 1.4 mm ABS without heat-seal adhesive <i>in all worktop colours</i> <i>Calculated per mm</i></p>	per metre	PLK1000	2

Standard corner joints are included in the price of the worktops:
Joints in 90° range, for corner worktops, set-forward units or worktop extensions.

7.11

Sealer strips

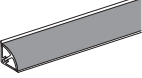
		width	universal
 <p>Sealer strip 25 mm high, 25 mm deep comprising: fastening strip, snap-on top cover</p> <p><i>Laminate finish</i></p> <p><i>Colours in all worktop colours, finish laminate</i> <i>Additional colour variants:</i></p> <p><i>Stainless steel-effect no. 558</i> <i>Black no. 120</i></p> <p><i>Only fixed lengths available.</i></p>	L1	200	9
	L1	300	14
	L1	400	17
<p>Sealer strip accessories Set of corners and end caps for sealer strips</p> <p>consisting of: 2 end caps left 2 end caps right 2 outer corners 90° 4 internal corners 90° 2 internal corners 135°</p> <p><i>Laminate finish</i></p>	MZWAP		4

Niche back panels

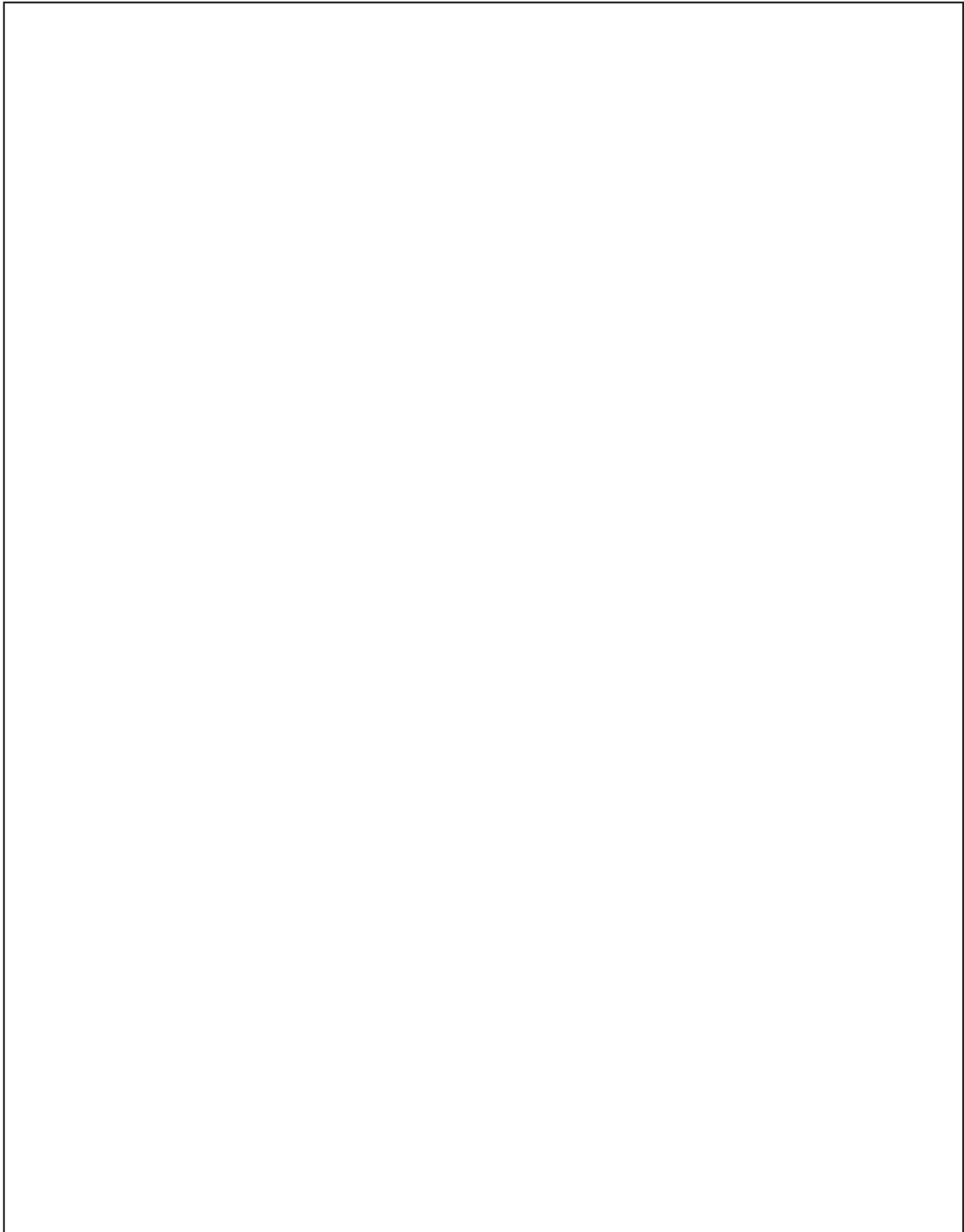

Niche back panels



Modular shelf unit for recess

Niche elements

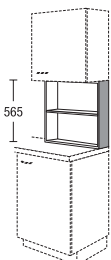
		width			universal
 <p>Modular shelf unit Depth 163 mm 1 fixed shelf <i>Finish in carcass material</i> <i>Not available in visible side colours.</i></p>	HR	30	57	16M	71
	HR	40	57	16M	76
	HR	45	57	16M	80
	HR	50	57	16M	83
	HR	60	57	16M	98
	HR	80	57	16M	103
	HR	90	57	16M	107

Niche back panels

Niche elements

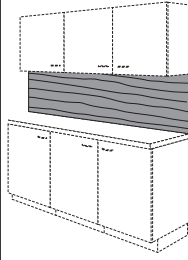
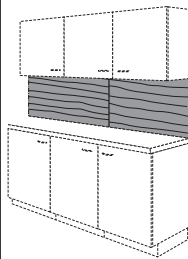
			width	universal
 <p>Niche back panel between worktop and wall units, approx. 16 mm thick 565 mm high, 150-2600 mm wide</p> <p><i>Finish in worktop colour (please specify) (feel may vary)</i></p> <p><i>In case of uneven wall, a flat surface must be prepared beforehand.</i></p> <p><i>Grain parallel to the worktop.</i></p> <p><i>Please note that for edge joins, the finishes are not continuous, but are offset.</i></p> <p><i>A minimum distance of 100 mm must be maintained between gas hobs and niche back panels.</i></p>  <p><i>The material thickness of the combi-sealer strip (5 mm) on the worktop must be taken into account when using a combi-sealer strip.</i></p> <p><i>The material thickness of the sealer strip (5 mm) must be taken into account for the niche height when using a sealer strip.</i></p> <p><i>Calculated per mm</i></p>	per metre	NR	565	32
<p>Niche back panel same as above, but between 25 mm worktop and wall units approx. 16 mm thick 580 mm high, 150-2600 mm wide</p> <p><i>Calculated per mm</i></p>	per metre	NR	580	37
<p>Niche back panel same as above, but 150 mm high, 150-2600 mm wide</p> <p><i>Calculated per mm</i></p>	per metre	NR	150	11
<p>Niche back panel, variable size same as above, but 150-1230 mm high, 150-2600 mm wide</p> <p><i>Calculated per mm²</i> <i>Minimum size calculated = 0.5 m²</i></p>	per m ²	NR	V	75

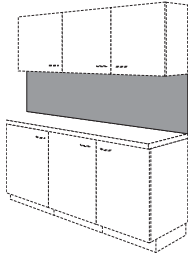

Niche back panels

Niche elements

			width		universal
	<p>Niche back panel with picture motif between worktop and wall units, approx. 16 mm thick 565 mm high, 150-2650 mm wide</p> <p><i>Support panel printed with picture motif (see range summary for picture motifs)</i></p> <p><i>The edge colour is white on all sides.</i></p> <p><i>In case of uneven wall, a flat surface must be prepared beforehand.</i></p> <p><i>Please note that for edge joins, the motifs are not continuous.</i></p> <p><i>A minimum distance of 100 mm must be maintained between gas hobs and niche back panels.</i></p> <p><i>Calculated per mm</i></p>	per metre	NRM	V	47
	<p>Niche back panel with picture motif same as above, but between 25 mm worktop and wall units approx. 16 mm thick 580 mm high, 150-2650 mm wide</p> <p><i>Calculated per mm</i></p>	per metre	NRM	V	580

Glass niche back panel

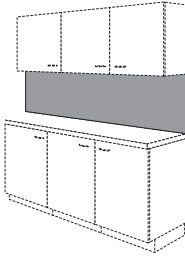
Niche elements

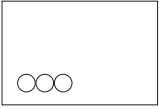
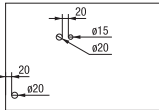
			width	universal
 <p>Glass niche back panel</p> <p>16 mm thick, toughened safety glass panel 4 mm dick, mounted on a support panel. Edges in aluminium-silver. The glass edges are ground. Combined sealer strip LG 200/400 required at bottom.</p> <p>Variable in height and width</p> <p>Max. length 2500 mm Max. height 1200 mm Min. length 250 mm.</p> <p>Minimum height without processing 100 mm, with processing 250 mm. Drawing with specific dimensions required. Cannot be reworked later (by the customer)!</p> <p>A minimum distance of 100 mm must be maintained between gas hobs and the glass niche.</p> <p>The material thickness of the combi-sealer strip (5 mm) on the worktop must be taken into account when using a combi-sealer strip.</p> <p>The material thickness of the sealer strip (5 mm) must be taken into account for the niche height when using a sealer strip.</p> <p>(glass colours see Summary of ranges)</p> <p>The express delivery services are not available for this item.</p> <p>Calculated per mm² Minimum size calculated = 0.5 m²</p>	per m ²	NRG	V	149
 <p>Cutout for switch/socket for glass niche back panel</p> <p>Dimensions apply up to middle of hole Minimum distance between outer edge and middle of drill hole: 68 mm</p> <p>With 2 or 3 drill holes: Distance from middle of hole to middle of hole 72 mm</p> <p>AUS 1S G</p>	Hole dia. 1 x 68 mm drill hole dia. 2 x 68 mm drill hole dia. 3 x 68 mm drill hole dia. 4 x 68 mm	AUS1SG AUS2SG AUS3SG AUS4SG		13 19 23 27
 <p>AUS 2S G</p>				
 <p>AUS 3S G</p>				
 <p>Drill hole in glass niche back panel</p> <p>The distance between the edge of a hole and the outer edge must at least be equal to the diameter of the hole (see sketch).</p> <p>The distance between holes must at least be equal to the diameter of the largest hole (see sketch).</p> <p>If drill diameter is less than 68 mm, then only the glass will be drilled. The carrier material is to be drilled on-site.</p>	drill hole dia. 5-12 mm drill hole dia. 13-50 mm drill hole dia. 51-100 mm	AUS12G AUS50G AUS100G		13 19 23

Glass niche back panel

Niche elements

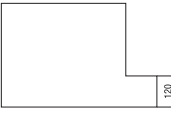
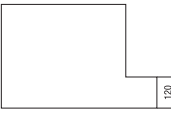
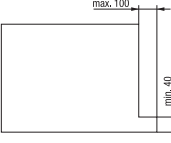
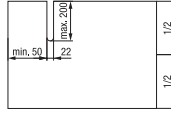
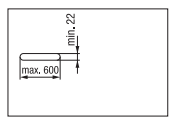
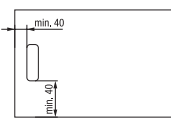
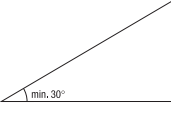
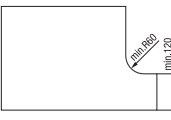
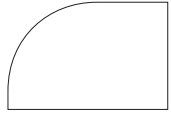
	width	universal
<p>Corner cut-out for glass niche back panel</p> <p>Internal radius of cutout: 11 mm The glass edges are ground.</p>  <p>An edge length of at least 50 mm must remain beside the corner cutout.</p> <p>The size of the cutout must not exceed half the pane size.</p> <p>If less than 120 mm of the edge (in this example 40 mm) remain when producing a cut-out, the width of the cut-out must not exceed 100 mm.</p>   	AUS4G	28
<p>Cut-out for glass niche back panel</p> <p>With 11 mm inside radius. The glass edges in the cutout are ground</p>  <p>Oblong cutouts have a maximum width of 120 mm and a minimum height of 22 mm.</p> <p>Distance from the edge equals 40 mm and 120 mm, as for cutouts.</p> <p>The size of the cutout must not exceed half the pane size.</p> <p>An edge at least 40 mm and at least 120 mm wide must remain when producing cutouts.</p> 	AUS44G	37
<p>Angled cut for glass niche back panel</p> <p>The glass edges are chamfered and ground.</p> 	AUS3G	28
<p>Rounded edges on glass niche back panels</p> <p>Inside radius 11 mm or more. The edges are ground. Glass edges are bevelled and ground on parts with outside radius.</p>  <p>The edge is bevelled and ground on an inside radius of more than 60 mm.</p> 	AUS7G	28

Glass niche back panel

Niche elements

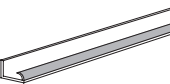
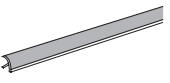
		width	universal
 <p>Combined sealer strip 30 mm high, 24 mm deep basic profile to receive niche walls or cover profiles incl. 1 accessory set LGZ 1, per order</p> <p><i>The material thickness of the combi-sealer strip (5 mm) on the worktop must be taken into account when planning a niche back panel.</i></p> <p><i>Colour finish:</i> stainless steel look no. 199 Black no. 120</p>	LG	200	7
	LG	400	13
<p>Accessories for combined sealer strip for aluminium and stainless-steel effect in grey, consisting of: 2 cover caps left 2 cover caps right</p>	LGZ1		2
 <p>Snap-on cover profile for combi-sealer strip to snap on to basic profile incl. 1 accessory set LAZ 1, per order</p> <p><i>Colour finish:</i> stainless steel look no. 199 Black no. 120</p>	LA	200	9
	LA	400	17
<p>Accessories for snap-on cover profile for aluminium and stainless-steel effect in grey, consisting of: 4 internal corners 90° 2 external corners 90° 2 internal corners 135° 2 cover caps left 2 cover caps right</p>	LAZ1		2

Worktops, accessories for niches

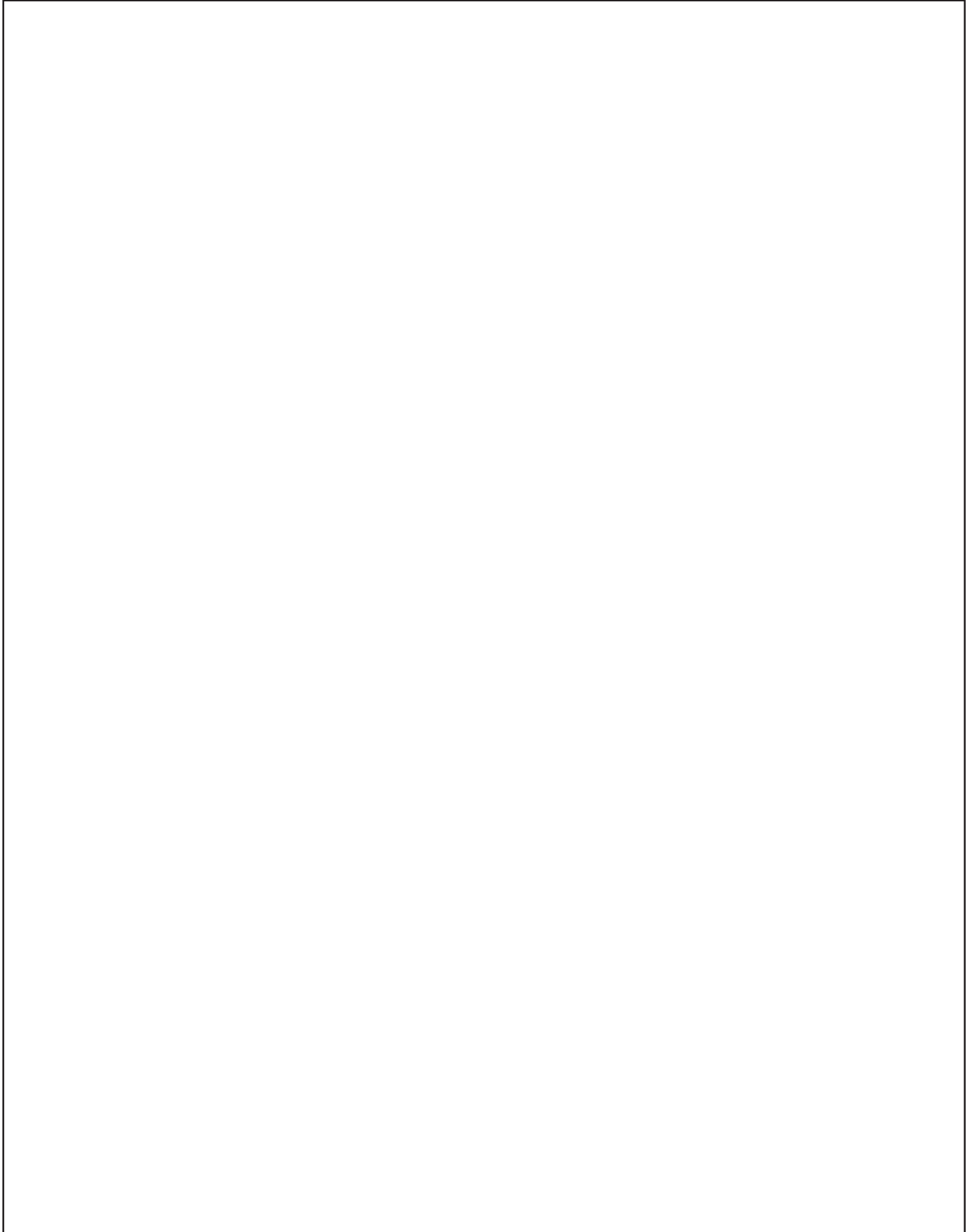

Worktops, accessories for
niches

Worktops, accessories for
niches



Worktop accessories

				width	Item	universal
 <p>Support leg for worktop tables Round gloss chrome Ø 60 mm steel tube Height adjustment 30 mm Loading capacity max. 150 kg</p>	705 to 735 mm	60	ZF 705 C	8		
	820 to 850 mm	60	ZF 820 C	9		
	870 to 900 mm	60	ZF 870 C	10		
	920 to 950 mm	60	ZF 920 C	11		
	1100 to 1130 mm	60	ZF 1100 C	12		
<p>Support leg for worktop tables Round same as above, but Stainless steel-effect</p>	705 to 735 mm	60	ZF 705 E	11		
	820 to 850 mm	60	ZF 820 E	12		
	870 to 900 mm	60	ZF 870 E	13		
	920 to 950 mm	60	ZF 920 E	14		
	1100 to 1130 mm	60	ZF 1100 E	15		
 <p>Support leg for worktop tables Rectangular Stainless steel-effect 60 x 60 mm Height can be adjusted by 10 mm Loading capacity max. 150 kg</p>	700 to 710 mm	60	ZF 705 QE	19		
	820 to 830 mm	60	ZF 820 QE	20		
	870 to 880 mm	60	ZF 870 QE	21		
	920 to 930 mm	60	ZF 920 QE	22		
	1100 to 1110 mm	60	ZF 1100 QE	23		
 <p>Support leg for worktop tables Rectangular same as above, but Black matt pearl-effect</p>	705 to 715 mm	60	ZF 705 QS	15		
	820 to 830 mm	60	ZF 820 QS	16		
	870 to 880 mm	60	ZF 870 QS	17		
	920 to 930 mm	60	ZF 920 QS	18		
	1100 to 1110 mm	60	ZF 1100 QS	19		
 <p>Support bracket for breakfast bar 170 mm high, 60 mm diameter max. distance 900 mm max. load 50 kg</p>	gloss chrome	60	ZK 17 RC	14		
	stainless steel-effect	60	ZK 17 RE	14		
 <p>Support bracket for breakfast bar 170 mm high, 50 x 50 mm Loading capacity max. 30 kg per metal support</p>	stainless steel-effect	50	ZK 17 QE	14		
	Black finely textured	50	ZK 17 QS	14		
 <p>Bracket to stabilise bar and table solutions 221 x 221 mm, 10 mm thick, 40 mm wide <i>Exclusively for joining free-standing modular panels to worktops.</i></p>	stainless steel	40	ZF 47 E	12		
 <p>Inductive charging area black for installation on-site 2 metre connecting cable with USB-A socket Transformer with USB-A connection socket 5V, IP 20 Output rating 5.0 W Drill hole 79 mm Installed depth including plug 40 mm 204 x 70 x 45 mm <i>For installation material thickness up to 40 mm</i></p>			ZLZLI 80 S	30		

Worktop accessories, Shelf accessories

		width	Item	universal
	<p>Ventilation grille for worktops</p> <p>80 mm deep cut-out size 440 x 71 mm plastic for fitting into worktop above radiators built-under refrigerators and built-in refrigerators</p> <p><i>Please specify colour:</i> 651 Silver grey 951 Black</p> <p><i>If no colour is stated with the order, delivery will be in 651 silver grey</i></p>	447	ZV LG A	5
	<p>Adhesive sealing tape for worktop</p> <p>Aluminium tape for sealing cut edges for hob and sink cut-outs</p> <p><i>Width: 50 mm</i></p>	<p>Length 5 metres 5000</p> <p>Length 50 metres 50000</p>	<p>ZVA 5 M</p> <p>ZVA 50 M</p>	<p>2</p> <p>12</p>
	<p>Shelf supports</p> <p>for shelves, glass shelves and cover panels</p> <p>2 items in set</p> <p><i>One set is necessary for each 750 mm started.</i></p> <p><i>adjustable for materials from 8 mm to 50 mm max. shelf depth 320 mm maximum safe load 8 kg each, incl. shelf weight</i></p>	<p>stainless steel-effect 30</p> <p>Black finely textured 30</p>	<p>ZN 850 E</p> <p>ZN 850 S</p>	<p>6</p> <p>6</p>
	<p>Shelf supports</p> <p>for shelves, glass shelves and cover panels</p> <p>2 items in set</p> <p><i>One set is necessary for each 750 mm started.</i></p> <p><i>Adjustable for material thicknesses from 8 mm to 40 mm Maximum pull-out shelf depth 320 mm Total loading capacity per carrier 20 kg (incl. shelf width) Depth of shelf support: 180 mm</i></p>	<p>stainless steel-effect 24</p> <p>Black finely textured 24</p>	<p>ZN 18 E</p> <p>ZN 18 S</p>	<p>8</p> <p>7</p>

Niche accessories

	width	Item	universal
 <p>Niche set stainless steel-effect consisting of: Recess profile 4 hooks 1 paper roll holder 2 hangers 1 shelf</p>	940	ZNP 90 E	18

Notes

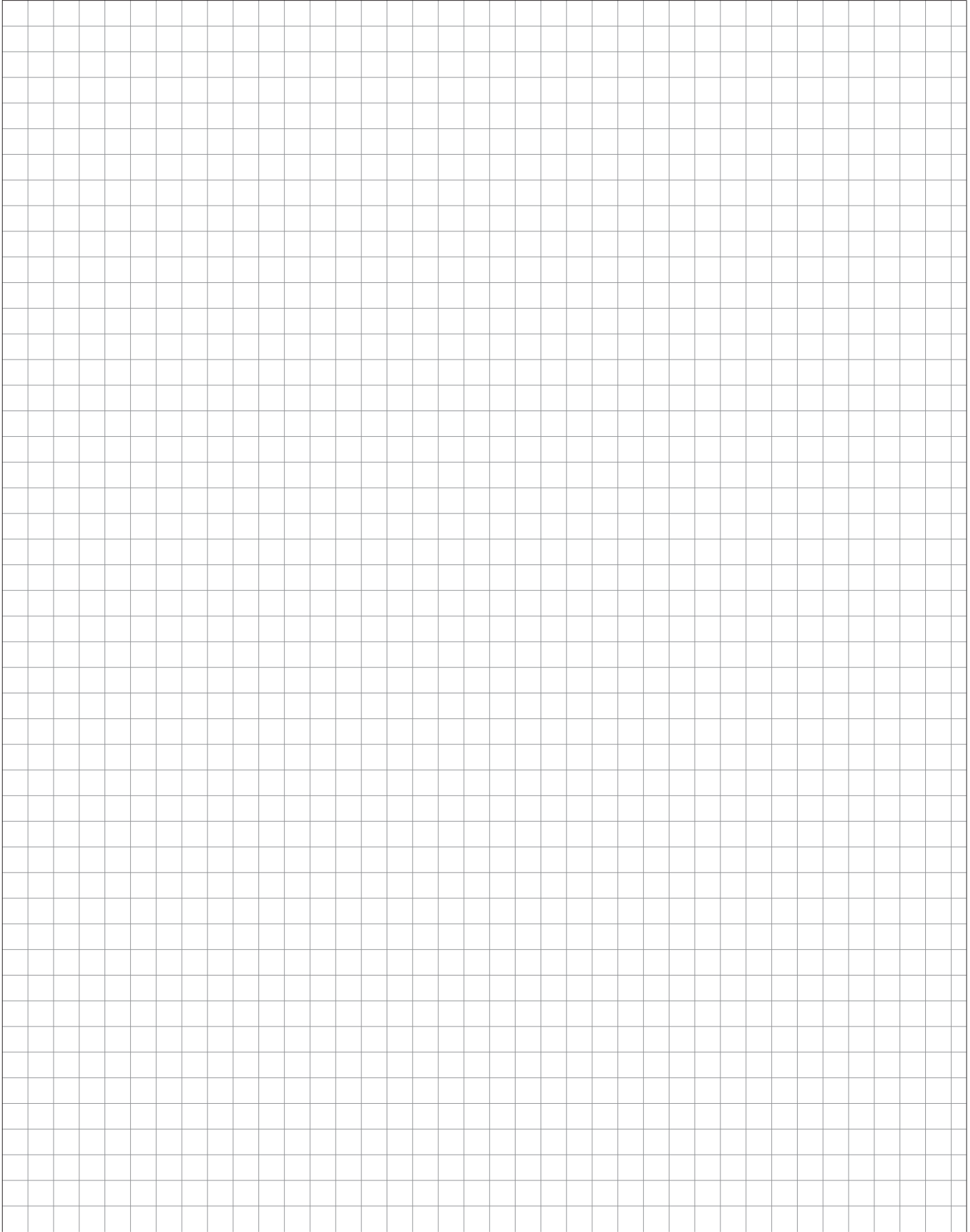

8. Plinth, cornice

Plinth panels
Cornices
Flyover shelves
Ceiling infill panels



8. Plinth, cornice

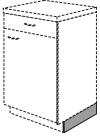

Plinth panels

		width	universal		
<p>Plinth panel version The plinth panels with sealing profile belonging to the kitchen will be generated automatically in line with the kitchen plan and need not be ordered separately. Any additional plinths will be charged at the prices stated.</p> <p>Colour finish See summary of carcass colours</p> <p><i>Indication of working height when ordering: 868 mm for 105 mm plinth height 918 mm for 155 mm plinth height 968 mm for 205 mm plinth height</i></p>					
 <p>Plinth panel 13 mm thick</p> <p>Version carcass and additional colours</p> <p><i>Maximum length: 3150 mm</i></p> <p>Plinth trim gloss as above</p> <p>Version surcharge group 1</p> <p>Plinth panel stainless steel-effect water resistant (plastic hollow section) as above Version surcharge group 2</p> <p>Plinth panel Colour Concept as above</p> <p>Surcharge</p> <p><i>Maximum length: 2700 mm</i></p>		S0	105		0
	for additional order	S0	105	2	5
		S0	210		0
	for additional order	S0	210	2	7
		S0	315		0
	for additional order	S0	315	2	9
		S0	105	3	7
		S0	210	3	10
		S0	315	3	14
		S0	105	4	11
		S0	210	4	21
		S0	315	4	32
		S0	135	CKM	27
		S0	270	CKM	52
 <p>Side return plinth panel</p> <p>Version carcass and additional colours</p>	540mm deep	S015			0
	540 mm deep for additional order	S015		2	2
	840mm deep	S0151			0
	840 mm deep for additional order	S0151		2	4

Plinth panels

			width		universal
Plinth trim gloss, side Version surcharge group 1	540 mm deep for additional order	S015		3	4
	840 mm deep for additional order	S0151		3	5
Side return plinth panel stainless steel-effect water resistant Version surcharge group 2	520mm deep	S015		4	7
	1050 mm deep	S0151		4	10
Side return plinth panel Colour Concept Surcharge	540mm deep	S0	15	CKM	14
	840mm deep	S0	151	CKM	19
Corner plinth Version carcass and additional colours	90°	SEP90			0
	90° for additional order	SEP90		2	1
Plinth corner profile stainless steel effect water resistant Version surcharge group 2	90°	SEP90		4	1
Plinth connecting profile Version carcass and additional colours <i>Can also be used with 135° corner solutions.</i>		SVP			0
	Finish carcass colours for additional order	SVP		2	1
	stainless steel-effect Surcharge group 2	SVP		4	1
Ventilation grille for plinth panel 1 each <i>Please specify colour: 651 Silver grey 951 Black</i> <i>If no colour is stated with the order, delivery will be in 651 silver grey</i>		ZV LG S			3
Waterproof plinth seal transparent Available length: 600 - 3150 mm <i>Calculated per mm</i>	per metre	L15			1

Plinth panels

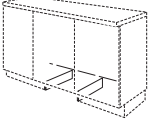
			width		universal	
 <p>Side return plinth panel Plinth garage for robot vacuum cleaner for 600 mm wide units 390 mm gap between the plinth panels Version carcass and additional colours <i>Plinth height min. 155 mm.</i> <i>Do not plan under refrigerators.</i></p>	500 mm deep	SOGA			21	
	<p>Plinth trim gloss, side Plinth garage for robot vacuum cleaner as above Version surcharge group 1</p>	500 mm deep	SOGA	3		29
	<p>Side return plinth panel Plinth garage for robot vacuum cleaner Colour Concept as above</p>	500 mm deep	SOGA	CKM		35
<p>Plinth panel and side plinth 13 mm thick including plinth corner profile left and right, and 1 connecting profile Version carcass and additional colours <i>Available plinth height: 155 mm</i></p>		S0	105	SET	11	
		S0	210	SET	13	
		S0	315	SET	15	

Cornices, Flyover shelves

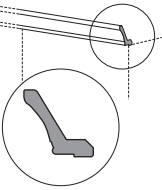
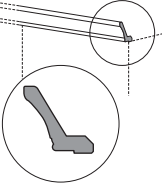
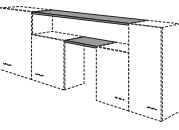
			width	universal
 <p>Country house cornice Height: 78 mm</p> <p><i>Carcase projection at front: 58 mm</i> <i>Price incl. mitre cuts</i></p> <p><i>Maximum length without join: 3600 mm</i></p> <p><i>Available according to sketch.</i></p> <p><i>Foil-wrapped finish</i></p> <p><i>Available in</i> <i>IP 4250, white No. 786</i> <i>IP 4250, magnolia white No. 787</i> <i>IP 4250, graphite No. 956</i> <i>IP 4250, space grey no. 957</i></p>	per metre	K78	F	27
 <p>Country house cornice Height: 78 mm</p> <p><i>Carcase projection at front: 58 mm</i> <i>Maximum length without join: 3600 mm</i></p> <p><i>Available according to sketch.</i></p> <p><i>Price incl. mitre cuts</i></p> <p><i>Calculated per mm</i></p> <p><i>Lacquered finish.</i> <i>Available in all Colour Concept colours</i></p>	per metre	K78	CK	36
 <p>Flyover shelf 16 mm thick, 326 mm deep available length from 300 mm to max. 2600 mm. load bearing up to max. 20 kg.</p> <p>To be fitted between wall units or between wall unit and tall unit.</p> <p><i>Fixing kit included.</i></p> <p><i>Finish in carcass material</i></p> <p><i>Colour version see summary of carcass colours</i></p> <p><i>Not available in visible side colours.</i></p> <p><i>Cutouts, for example for cooker hood chimneys, on site.</i></p> <p><i>Please order full-width cornice required separately.</i></p> <p><i>Calculated per mm</i></p>	per metre	GSB		24

Ceiling infill panels

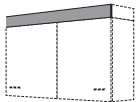
		width	universal
<p>Ceiling infill panels 16 mm thick, 326 mm high, without corner and sealing profiles.</p> <p>Ceiling infill panel Height: 326 mm</p>  <p>A ventilation shaft with 200 cm² cross-section is needed for floor-to-ceiling panelling above appliance housings. The worktop ventilation grill is used for this purpose.</p> <p><i>Maximum length: 2600 mm</i></p> <p><i>Finish in carcass material</i></p> <p><i>Available in all carcass finishes.</i></p> <p><i>Not available in visible side colours.</i></p> <p><i>Calculated per mm</i></p>	DB	33	26

Notes

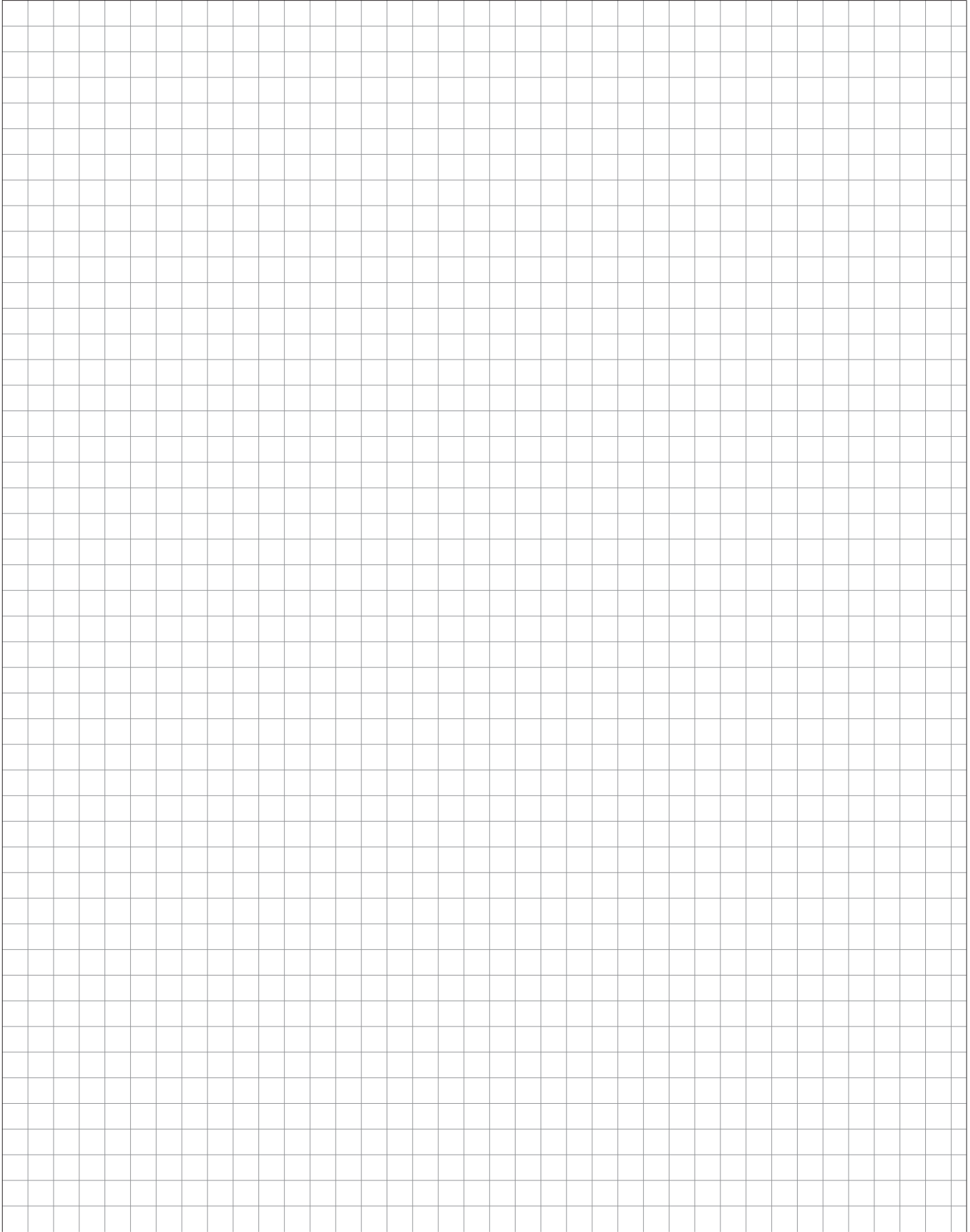

9. Design elements

Storage space / utility room
Country-house style
Single parts
Surcharges/miscellaneous



Storage space / utility room

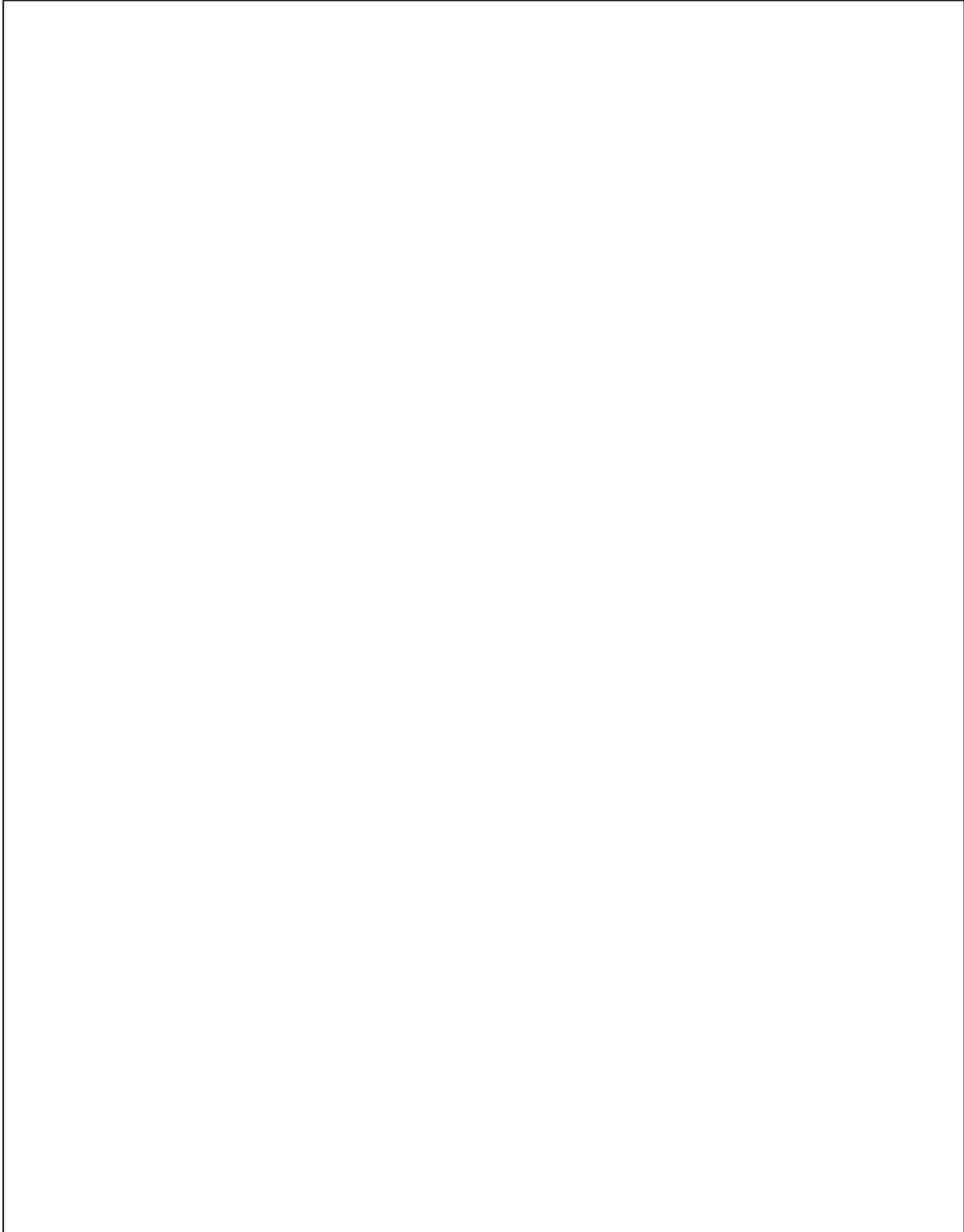





Storage space / utility
room



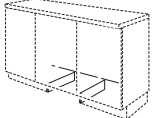
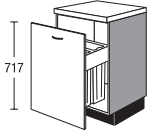

Storage space / utility room

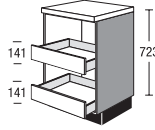
Base unit range

				Price group												
				width	1	2	3	4	5	6	7	Servosoft	Pro Servosoft	ProServoglass	Soft closing Top Motion	Soft closing Top Motion Plus
 <p>Side return plinth panel Plinth garage for robot vacuum cleaner for 600 mm wide units 390 mm gap between the plinth panels Version carcass and additional colours <i>Plinth height min. 155 mm.</i> <i>Do not plan under refrigerators.</i></p>	SOGA			500 mm deep	21	21	21	21	21	21	21	-	-	-	-	-
	SOGA	3		500 mm deep	29	29	29	29	29	29	29	-	-	-	-	-
	SOGA	CKM		500 mm deep	35	35	35	35	35	35	35	-	-	-	-	-
 <p>Base unit with laundry baskets 1 deep drawer 2 laundry baskets, 40 litres Laminate, white</p> 	UA	60	WK2		180	193	204	215	240	257	278	5	8	8	-	-
 <p>Base unit for collecting recyclables 1 deep drawer 1 swing lid 1 recycling bin Capacity approx. 53 litres</p> 	UA	40	M		144	154	164	174	195	210	230	5	8	16	-	-
 <p>Base unit for bottle crates 2 drawers <i>Unit interior in carcass decor.</i> <i>Not available in visible side colours.</i> <i>Unit without handles.</i></p>	UR2S	60			205	227	239	251	290	312	329	10	16	16	-	-

Storage space / utility room

Wall unit range 579 mm (01), 723 mm (02) high

				width	Price group							Servosoft	Pro Servosoft	ProServoGlass	Soft closing Top Motion	Soft closing Top Motion Plus	
					1	2	3	4	5	6	7						
 <p>Wall unit 1 flap door 1 open niche at bottom 579 mm high <i>Unit interior in carcass decor.</i> <i>Not available in visible side colours.</i></p>	<input type="checkbox"/>	HK	30	01	RU	66	69	72	75	81	92	106	-	-	-	4	14
	<input type="checkbox"/>	HK	45	01	RU	72	75	78	81	86	96	110	-	-	-	4	14
	<input type="checkbox"/>	HK	50	01	RU	74	78	81	85	91	102	116	-	-	-	4	14
	<input type="checkbox"/>	HK	60	01	RU	78	83	87	91	98	108	123	-	-	-	4	14
 <p>Wall unit 1 flap door 1 open niche at bottom 723 mm high <i>Unit interior in carcass decor.</i> <i>Not available in visible side colours.</i></p>	<input type="checkbox"/>	HK	30	02	RU	71	74	78	80	87	99	114	-	-	-	4	14
	<input type="checkbox"/>	HK	45	02	RU	79	83	86	89	94	106	121	-	-	-	4	14
	<input type="checkbox"/>	HK	50	02	RU	81	85	89	93	99	112	127	-	-	-	4	14
	<input type="checkbox"/>	HK	60	02	RU	84	90	94	98	105	117	132	-	-	-	4	14

Storage space / utility room

Dresser units

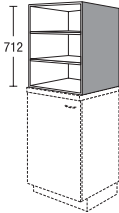
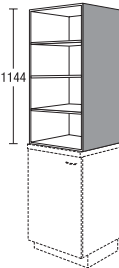
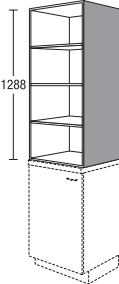
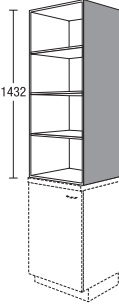
		width		universal	
 <p>Dresser shelf unit 712 mm high (1475 highboard height) to be placed on a 40 mm thick worktop 2 adjustable shelves <i>Finish in carcase material</i> <i>Not available in visible side colours.</i></p>	<input type="checkbox"/> D	AR	60	148	148
	<input type="checkbox"/> D	AR	65	148	166
 <p>Dresser shelf unit 1144 mm high (height 01) to be placed on a 40 mm thick worktop 3 adjustable shelves <i>Finish in carcase material</i> <i>Not available in visible side colours.</i></p>	<input type="checkbox"/> D	AR	60	01	172
	<input type="checkbox"/> D	AR	65	01	192
 <p>Dresser shelf unit 1288 mm high (height 02) to be placed on a 40 mm thick worktop 3 adjustable shelves <i>Finish in carcase material</i> <i>Not available in visible side colours.</i></p>	<input type="checkbox"/> D	AR	60	02	180
	<input type="checkbox"/> D	AR	65	02	199
 <p>Dresser shelf unit 1432 mm high (height 03) to be placed on a 40 mm thick worktop 3 adjustable shelves <i>Finish in carcase material</i> <i>Not available in visible side colours.</i></p>	<input type="checkbox"/> D	AR	60	03	187
	<input type="checkbox"/> D	AR	65	03	207

Storage space / utility room

Tall units 1907 mm

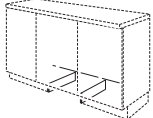
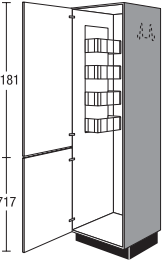
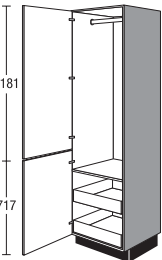
			width	Price group							Servosoft	Pro Servosoft	ProServoGlass	Soft closing Top Motion	Soft closing Top Motion Plus			
				1	2	3	4	5	6	7								
 <p>Side return plinth panel Plinth garage for robot vacuum cleaner for 600 mm wide units 390 mm gap between the plinth panels Version carcass and additional colours <i>Plinth height min. 155 mm.</i> <i>Do not plan under refrigerators.</i></p>	SOGA		500 mm deep					21	21	21	21	21	21	21	-	-	-	-
	SOGA	3	500 mm deep					29	29	29	29	29	29	29	-	-	-	-
	SOGA	CKM	500 mm deep					35	35	35	35	35	35	35	-	-	-	-
 <p>Tall broom cupboard</p> <ul style="list-style-type: none"> <input checked="" type="checkbox"/> S 1 door (dowelled) <input checked="" type="checkbox"/> S 1 wire shelf <input checked="" type="checkbox"/> S 1 hook for brooms <p>1 universal holder for cable, hose and vacuum cleaner accessories storage of vacuum cleaner, step ladder or ironing board possible <i>No wire parts if depth is reduced to less than 410 mm.</i> <i>Grip ledges are fitted at the works to both side-hung doors in order to achieve a continuous joint pattern.</i></p>	S	45	01	B	139	148	157	166	185	203	227	-	-	-	10	10		
	S	50	01	B	141	152	161	170	190	208	231	-	-	-	10	10		
	S	60	01	B	143	154	163	172	192	210	233	-	-	-	10	10		
 <p>Tall unit</p> <ul style="list-style-type: none"> 1 door (dowelled) 1 garment rail 1 fixed shelf 2 internal drawers <p><i>The hinged doors must open to an angle of at least 90° (observe handle spacing).</i> <i>Grip ledges are fitted at the works to both side-hung doors in order to achieve a continuous joint pattern.</i></p>	S	60	01	GIS	218	224	233	242	260	277	304	10	16	16	10	10		

Storage space / utility room

Tall units 1907 mm

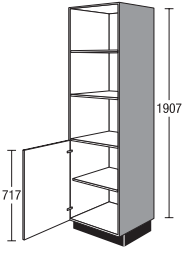
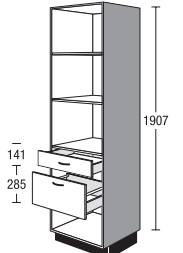
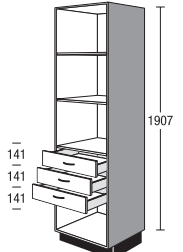
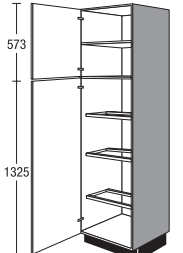
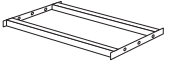
				Price group												
				width	1	2	3	4	5	6	7	Servosoft	Pro Servosoft	ProServoglass	Soft closing Top Motion	Soft closing Top Motion Plus
 <p>Tall unit 2 adjustable shelves 1 hinged door 1 adjustable shelf <i>Unit interior in carcass decor.</i> <i>Not available in visible side colours.</i></p>	SRT	50	01		261	275	281	291	303	309	314	-	-	-	4	4
	SRT	60	01	267	280	287	297	308	315	320	-	-	-	4	4	
 <p>Tall unit 2 adjustable shelves 1 drawer 1 deep drawer <i>Unit interior in carcass decor.</i> <i>Not available in visible side colours.</i></p>	SRSA	50	01	298	317	325	337	357	373	390	10	16	16	-	-	
	SRSA	60	01	317	337	344	356	376	393	409	10	16	16	-	-	
 <p>Tall unit 2 adjustable shelves 3 drawers <i>Unit interior in carcass decor.</i> <i>Not available in visible side colours.</i></p>	SR3S	50	01	322	341	349	361	381	398	414	15	24	24	-	-	
	SR3S	60	01	338	358	366	377	398	414	431	15	24	24	-	-	
 <p>Tall unit for bottle crates 1 hinged door 1 adjustable shelf 1 hinged door 3 supporting frames for bottle crates</p> <p>Suitable additions:</p> <p>Supporting frames for bottle crates, individual silver-grey</p> 	S	60	01	GK9	268	284	295	307	330	352	386	-	-	-	10	10
	ZIGK	60			13	13	13	13	13	13	13	-	-	-	-	-

Storage space / utility room

Tall units 1907 mm

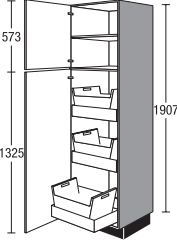
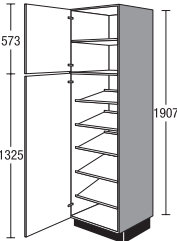
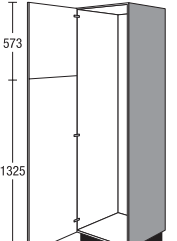
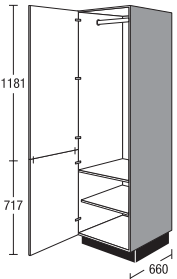
		width	Price group							Servosoft	Pro Servosoft	ProServoGlass	Soft closing Top Motion	Soft closing Top Motion Plus		
			1	2	3	4	5	6	7							
 <p>Wall unit with laundry baskets</p> <p>1 hinged door 1 adjustable shelf 1 hinged door 3 interior drawers 3 laundry baskets, each 41 litres Laminate, white</p> <p><i>The hinged doors must open to an angle of at least 90° (observe handle spacing).</i></p>	S	60	01	WK9	367	382	397	412	444	474	520	15	24	24	10	10
 <p>Tall unit for shoes</p> <p>1 hinged door 1 adjustable shelf 1 hinged door 5 fixed shelves for shoes</p>	S	60	01	S9	252	269	284	301	335	367	409	-	-	-	10	10
 <p>Tall unit for individual equipping</p> <p>1 hinged door (dowelled)</p> <p><i>Grip ledges are fitted at the works to both side-hung doors in order to achieve a continuous joint pattern.</i></p> <p>Suitable additions:</p> <p>Accessories for individual equipping See Accessories and Accessories K-Line side</p>	S	60	01	Z9	138	147	156	164	183	201	224	-	-	-	10	10
 <p>Tall unit with clothes rail</p> <p>Carcase depth 660 mm</p> <p>NEW NEW NEW</p> <p>1 door (dowelled) 1 garment rail 1 fixed shelf 1 adjustable shelf</p> <p><i>Grip ledges are fitted at the works to both side-hung doors in order to achieve a continuous joint pattern.</i></p>	S	45	01	66G1	179	184	191	199	213	227	250	-	-	-	10	10
	S	50	01	66G1	187	192	200	208	223	238	261	-	-	-	10	10
	S	60	01	66G1	206	212	220	229	246	261	288	-	-	-	10	10

Storage space / utility room

Tall units 1907 mm

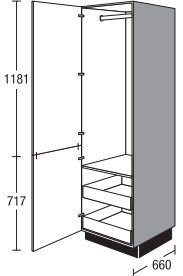
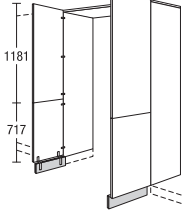
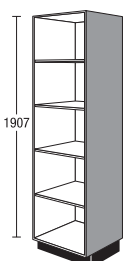
				width	Price group							Servosoft	Pro Servosoft	ProServoglass	Soft closing Top Motion	Soft closing Top Motion Plus				
					1	2	3	4	5	6	7									
 <p>Tall unit with clothes rail</p> <p>Carcase depth 660 mm</p> <ul style="list-style-type: none"> 1 door (dowelled) 1 garment rail 1 fixed shelf 2 internal drawers <p><i>Grip ledges are fitted at the works to both side-hung doors in order to achieve a continuous joint pattern.</i></p>				S	45	01	66GIS	233	239	249	259	278	296	325	-	-	-	10	10	
				S	50	01	66GIS	241	248	258	268	287	306	336	-	-	-	10	10	
				S	60	01	66GIS	260	267	278	289	310	330	363	-	-	-	10	10	
 <p>Access door</p> <ul style="list-style-type: none"> 2 doors (dowelled) 2 end panels, 16 mm thick, same colour and height as carcass 1 top panel, 16 mm thick, same colour as carcass 2 plinth panels in same colour as carcass, including connecting angle <p><i>Available for the following ranges: IP 1200, IP 2200, IP 3150, IP 4050</i></p> <p><i>Not available in the following plinth decor: 299 Stainless steel effect</i></p> <p><i>Only plan between 2 tall units in height 01.</i></p> <p><i>The delivery comprises several packages.</i></p>				DG	90	01		197	210	222	-	-	-	-	-	-	-	20	20	
				DG	100	01		202	215	228	-	-	-	-	-	-	-	-	-	20
 <p>Tall shelf unit</p> <ul style="list-style-type: none"> 4 adjustable shelves <p><i>Finish in carcass material</i></p> <p><i>Please indicate desired width (150-600 mm).</i></p> <p><i>Not available in visible side colours.</i></p>				SR	V	01		222	222	222	222	222	222	222	-	-	-	-	-	

Storage space / utility room

Tall units 1907 mm

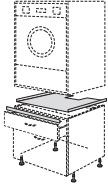
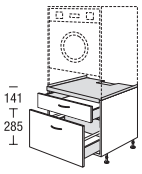
		width		Price group												
				1	2	3	4	5	6	7	Servosoft	Pro Servosoft	ProServoGlass	Soft closing Top Motion	Soft closing Top Motion Plus	
	<p>Installation accessories for built-under washing machine / dryer</p> <p>Set consisting of: 1 metal plate, white 1 metal securing bracket 4 metal plinth feet</p> <p><i>Only available for plinth height 155 mm.</i></p>	MZWM		73	73	73	73	73	73	73	-	-	-	-	-	
	<p>Modular unit for raised washing machine/dryer</p> <p>for raised installation of washing machine/dryer</p> <p>Set comprising: 1 base unit 435 mm high with 1 drawer with side supports for laundry basket 1 deep drawer 1 metal plate 1 metal securing bracket 4 metal plinth feet</p> <p><i>The metal plinth feet must be installed on-site.</i></p> <p><i>Washing machine/dryer - please check whether approved for raised installation.</i></p> <p><i>Only available for plinth height 155 mm.</i></p> <p><i>The delivery comprises several packages.</i></p> <p>Safety precautions: <i>Only washing machines and tumble dryers with electronic out-of-balance control are to be used.</i> <i>The cabinet must be firmly secured to the wall.</i> <i>Only condensation and heat pump dryers are approved.</i> <i>The maximum load capacity is 130 kg, including wet laundry.</i> <i>If escaping water should cause damage from swelling in spite of using the moisture protection shield, the furniture is no longer in proper working order and must be taken out of use.</i> <i>Please follow the appliance manufacturer's conditions of installation and use.</i></p>	GWSA	60	46	291	314	344	374	451	484	526	10	16	24	-	-

Storage space / utility room

Tall units 1907 mm

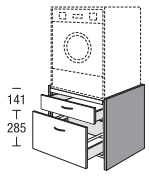
		width		Price group												
		1	2	3	4	5	6	7	Servosoft	Pro Servosoft	ProServoglass	Soft closing Top Motion	Soft closing Top Motion Plus			
	<p>Modular unit for raised washing machine/dryer</p> <p>Including panels</p> <p>for raised installation of washing machine/dryer</p> <p>Set comprising:</p> <ul style="list-style-type: none"> 2 side panels 16 mm wide, 685 mm deep 2 panel shoes 885 mm deep 1 base unit 435 mm high with 1 drawer with side supports for laundry basket 1 deep drawer 1 metal plate 1 metal securing bracket 4 metal plinth feet <p><i>Panel finish:</i></p> <p><i>Panel colours</i></p> <p><i>Not available for Colour Concept support panels.</i></p> <p><i>Not available in visible side colours.</i></p> <p><i>The metal plinth feet must be installed on-site.</i></p> <p><i>Washing machine/dryer - please check whether approved for raised installation.</i></p> <p><i>Only available for plinth height 155 mm.</i></p> <p><i>The delivery comprises several packages.</i></p> <p>Safety precautions:</p> <p><i>Only washing machines and tumble dryers with electronic out-of-balance control are to be used.</i></p> <p><i>The cabinet must be firmly secured to the wall.</i></p> <p><i>Only condensation and heat pump dryers are approved.</i></p> <p><i>The maximum load capacity is 130 kg, including wet laundry.</i></p> <p><i>If escaping water should cause damage from swelling in spite of using the moisture protection shield, the furniture is no longer in proper working order and must be taken out of use.</i></p> <p><i>Please follow the appliance manufacturer's conditions of installation and use.</i></p>	GWSA	63	46	330	358	388	418	495	528	569	10	16	24	-	-

Storage space / utility room

Tall units 1907 mm

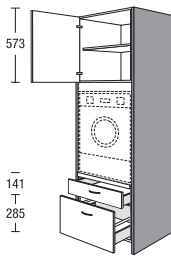
	width	Price group							Servosoft	Pro Servosoft	ProServoGlass	Soft closing Top Motion	Soft closing Top Motion Plus		
		1	2	3	4	5	6	7							
 <p>Modular unit for raised washing machine/dryer Including panels for raised installation of washing machine/dryer niche height 890 mm</p> <p>Set comprising: 2 side panels (16 mm with panel support, 685 mm deep) 1 top unit with 1 hinged door 1 adjustable shelf 1 base unit 435 mm high with 1 drawer with side supports for laundry basket 1 deep drawer 1 metal plate 1 metal securing bracket 4 metal plinth feet</p> <p><i>Panel finish:</i> <i>Panel colours</i> Not available for Colour Concept support panels.</p> <p><i>Not available in visible side colours.</i></p> <p><i>The metal plinth feet must be installed on-site.</i></p> <p><i>Washing machine/dryer - please check whether approved for raised installation.</i></p> <p><i>Only available for plinth height 155 mm.</i></p> <p><i>The delivery comprises several packages.</i></p> <p>Safety precautions: Only washing machines and tumble dryers with electronic out-of-balance control are to be used. The cabinet must be firmly secured to the wall. Only condensation and heat pump dryers are approved. The maximum load capacity is 130 kg, including wet laundry. If escaping water should cause damage from swelling in spite of using the moisture protection shield, the furniture is no longer in proper working order and must be taken out of use.</p>	GWSA	63	01	428	456	490	524	610	652	706	10	16	24	4	4

Storage space / utility room

Tall units 2051 mm

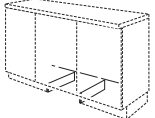
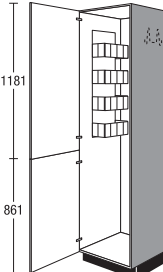
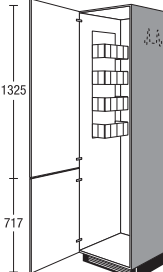
						Price group											
						1	2	3	4	5	6	7	Servosoft	Pro Servosoft	ProServoglass	Soft closing Top Motion	Soft closing Top Motion Plus
 <p>Side return plinth panel Plinth garage for robot vacuum cleaner for 600 mm wide units 390 mm gap between the plinth panels Version carcass and additional colours <i>Plinth height min. 155 mm.</i> Do not plan under refrigerators.</p>		SOGA				21	21	21	21	21	21	21	-	-	-	-	-
		SOGA	3			29	29	29	29	29	29	29	-	-	-	-	-
		SOGA	CKM				35	35	35	35	35	35	-	-	-	-	-
 <p>Tall broom cupboard 1 door (dowelled) 1 wire shelf 1 hook for brooms 1 universal holder for cable, hose and vacuum cleaner accessories stowage of vacuum cleaner, step ladder or ironing board possible <i>No wire parts if depth is reduced to less than 410 mm.</i> Grip ledges are fitted at the works to both side-hung doors in order to achieve a continuous joint pattern.</p>	<input checked="" type="checkbox"/>	S	45	02	B2	142	154	164	174	197	217	242	-	-	-	10	10
	<input checked="" type="checkbox"/>	S	50	02	B2	146	159	170	181	203	223	248	-	-	-	10	10
	<input checked="" type="checkbox"/>	S	60	02	B2	156	169	179	190	214	234	260	-	-	-	10	10
 <p>Tall broom cupboard 1 door (dowelled) 1 wire shelf 1 hook for brooms 1 universal holder for cable, hose and vacuum cleaner accessories stowage of vacuum cleaner, step ladder or ironing board possible <i>No wire parts if depth is reduced to less than 410 mm.</i> Grip ledges are fitted at the works to both side-hung doors in order to achieve a continuous joint pattern.</p>	<input checked="" type="checkbox"/>	S	60	02	B	156	169	179	190	214	234	260	-	-	-	10	10

Storage space / utility room

Tall units 2051 mm

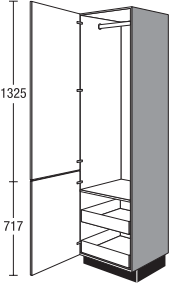
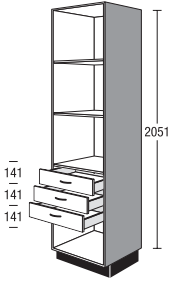
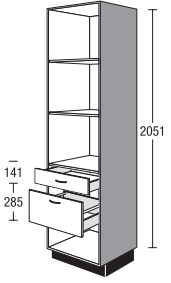
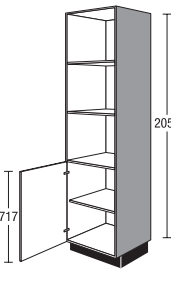
		width	Price group							Servosoft	Pro Servosoft	ProServoGlass	Soft closing Top Motion	Soft closing Top Motion Plus		
			1	2	3	4	5	6	7							
 <p>Tall unit 1 door (dowelled) 1 garment rail 1 fixed shelf 2 internal drawers</p> <p><i>The hinged doors must open to an angle of at least 90° (observe handle spacing).</i></p> <p><i>Grip ledges are fitted at the works to both side-hung doors in order to achieve a continuous joint pattern.</i></p>	S	60	02	GIS	231	240	249	260	282	302	329	10	16	16	10	10
 <p>Tall unit 2 adjustable shelves 3 drawers</p> <p><i>Unit interior in carcass decor.</i></p> <p><i>Not available in visible side colours.</i></p>	SR3S	50	02		325	344	352	364	384	401	417	15	24	24	-	-
	SR3S	60	02		346	366	373	385	405	422	438	15	24	24	-	-
 <p>Tall unit 2 adjustable shelves 1 drawer 1 deep drawer</p> <p><i>Unit interior in carcass decor.</i></p> <p><i>Not available in visible side colours.</i></p>	SRSA	50	02		304	324	332	343	364	380	397	10	16	16	-	-
	SRSA	60	02		325	344	352	364	384	401	417	10	16	16	-	-
 <p>Tall unit 2 adjustable shelves 1 hinged door 1 adjustable shelf</p> <p><i>Unit interior in carcass decor.</i></p> <p><i>Not available in visible side colours.</i></p>	SRT	50	02		254	268	275	284	296	303	307	-	-	-	4	4
	SRT	60	02		274	288	295	305	316	323	328	-	-	-	4	4

Storage space / utility room

Tall units 2051 mm

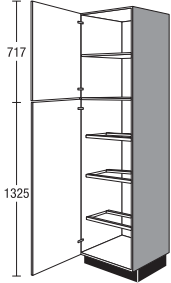
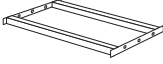
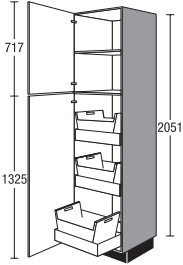
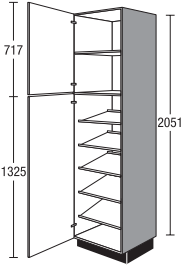
		width	Price group							Servosoft	Pro Servosoft	ProServoglass	Soft closing Top Motion	Soft closing Top Motion Plus		
			1	2	3	4	5	6	7							
 <p>Tall unit for bottle crates 1 hinged door 1 adjustable shelf 1 hinged door 3 supporting frames for bottle crates</p>	S	60	02	GK9	281	301	313	327	356	380	415	-	-	-	10	10
	<p>Suitable additions:</p> <p>Supporting frames for bottle crates, individual silver-grey</p> 		ZIGK	60			13	13	13	13	13	13	-	-	-	-
 <p>Wall unit with laundry baskets 1 hinged door 1 adjustable shelf 1 hinged door 3 interior drawers 3 laundry baskets, each 41 litres Laminate, white</p> <p><i>The hinged doors must open to an angle of at least 90° (observe handle spacing).</i></p>	S	60	02	WK9	378	404	420	437	476	509	556	15	24	24	10	10
 <p>Tall unit for shoes 1 hinged door 1 adjustable shelf 1 hinged door 5 fixed shelves for shoes</p>	S	60	02	S9	266	286	304	323	361	395	438	-	-	-	10	10

Storage space / utility room

Tall units 2051 mm

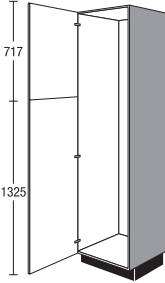
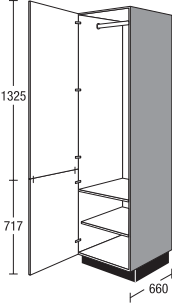
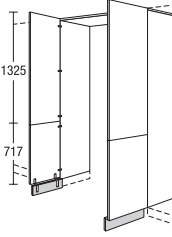
		width	Price group							Servosoft	Pro Servosoft	ProServoGlass	Soft closing Top Motion	Soft closing Top Motion Plus		
			1	2	3	4	5	6	7							
 <p>Tall unit for individual equipping 1 hinged door (dowelled) <i>Grip ledges are fitted at the works to both side-hung doors in order to achieve a continuous joint pattern.</i></p> <p>Suitable additions:</p> <p>Accessories for individual equipping See Accessories and Accessories K-Line side</p>	S	60	02	Z9	150	162	171	182	204	223	247	-	-	-	10	10
 <p>Tall unit with clothes rail</p> <p>Carcase depth 660 mm</p> <p>1 door (dowelled) 1 garment rail 1 fixed shelf 1 adjustable shelf</p> <p><i>Grip ledges are fitted at the works to both side-hung doors in order to achieve a continuous joint pattern.</i></p>	S	45	02	66G1	188	204	213	228	250	271	299	-	-	-	10	10
	S	50	02	66G1	197	213	223	239	262	285	313	-	-	-	10	10
	S	60	02	66G1	219	236	250	266	297	326	361	-	-	-	10	10
 <p>Access door</p> <p>2 doors (dowelled) 2 end panels, 16 mm thick, same colour and height as carcase 1 top panel, 16 mm thick, same colour as carcase 2 plinth panels in same colour as carcase, including connecting angle</p> <p><i>Available for the following ranges: IP 1200, IP 2200, IP 3150, IP 4050</i></p> <p><i>Not available in the following plinth decor: 299 Stainless steel effect</i></p> <p><i>Only plan between 2 tall units in height 02.</i></p> <p><i>The delivery comprises several packages.</i></p>	DG	90	02		206	222	235	-	-	-	-	-	-	-	20	20
	DG	100	02		211	227	241	-	-	-	-	-	-	-	-	20

Storage space / utility room

Tall units 2051 mm

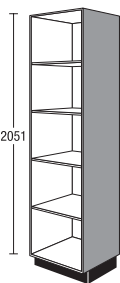
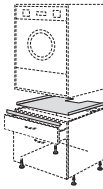
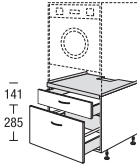
		width	Price group							Servosoft	Pro Servosoft	ProServoglass	Soft closing Top Motion	Soft closing Top Motion Plus		
			1	2	3	4	5	6	7							
 <p>2051</p>	<p>Tall shelf unit</p> <p>4 adjustable shelves</p> <p><i>Finish in carcass material</i></p> <p><i>Please indicate desired width (150-600 mm).</i></p> <p><i>Not available in visible side colours.</i></p>	SR	V	02	229	229	229	229	229	229	229	-	-	-	-	-
	 <p>Installation accessories for built-under washing machine / dryer</p> <p>Set consisting of:</p> <ul style="list-style-type: none"> 1 metal plate, white 1 metal securing bracket 4 metal plinth feet <p><i>Only available for plinth height 155 mm.</i></p>	MZWM			73	73	73	73	73	73	73	-	-	-	-	-
	 <p>141 T 285 L</p> <p>Modular unit for raised washing machine/dryer</p> <p>for raised installation of washing machine/dryer</p> <p>Set comprising:</p> <ul style="list-style-type: none"> 1 base unit 435 mm high with 1 drawer with side supports for laundry basket 1 deep drawer 1 metal plate 1 metal securing bracket 4 metal plinth feet <p><i>The metal plinth feet must be installed on-site.</i></p> <p><i>Washing machine/dryer - please check whether approved for raised installation.</i></p> <p><i>Only available for plinth height 155 mm.</i></p> <p><i>The delivery comprises several packages.</i></p> <p>Safety precautions:</p> <ul style="list-style-type: none"> <i>Only washing machines and tumble dryers with electronic out-of-balance control are to be used.</i> <i>The cabinet must be firmly secured to the wall.</i> <i>Only condensation and heat pump dryers are approved.</i> <i>The maximum load capacity is 130 kg, including wet laundry.</i> <i>If escaping water should cause damage from swelling in spite of using the moisture protection shield, the furniture is no longer in proper working order and must be taken out of use.</i> <i>Please follow the appliance manufacturer's conditions of installation and use.</i> 	GWSA	60	46	291	314	344	374	451	484	526	10	16	24	-	-

Storage space / utility room

Tall units 2051 mm

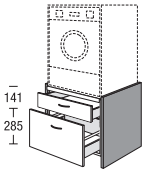
	width	Price group							Servosoft	Pro Servosoft	ProServoGlass	Soft closing Top Motion	Soft closing Top Motion Plus		
		1	2	3	4	5	6	7							
 <p>Modular unit for raised washing machine/dryer Including panels for raised installation of washing machine/dryer</p> <p>Set comprising: 2 side panels 16 mm wide, 685 mm deep 2 panel shoes 885 mm deep 1 base unit 435 mm high with 1 drawer with side supports for laundry basket 1 deep drawer 1 metal plate 1 metal securing bracket 4 metal plinth feet</p> <p><i>Panel finish:</i> <i>Panel colours</i> Not available for Colour Concept support panels.</p> <p><i>Not available in visible side colours.</i></p> <p><i>The metal plinth feet must be installed on-site.</i></p> <p><i>Washing machine/dryer - please check whether approved for raised installation.</i></p> <p><i>Only available for plinth height 155 mm.</i></p> <p><i>The delivery comprises several packages.</i></p> <p>Safety precautions: Only washing machines and tumble dryers with electronic out-of-balance control are to be used. The cabinet must be firmly secured to the wall. Only condensation and heat pump dryers are approved. The maximum load capacity is 130 kg, including wet laundry. If escaping water should cause damage from swelling in spite of using the moisture protection shield, the furniture is no longer in proper working order and must be taken out of use. Please follow the appliance manufacturer's conditions of installation and use.</p>	GWSA	63	46	330	358	388	418	495	528	569	10	16	24	-	-

Storage space / utility room

Tall units 2051 mm

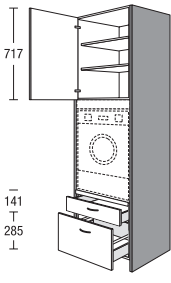
			Price group													
			width	1	2	3	4	5	6	7	Servosoft	Pro Servosoft	ProServoglass	Soft closing Top Motion	Soft closing Top Motion Plus	
	<p>Modular unit for raised washing machine/dryer</p> <p>Including panels</p> <p>for raised installation of washing machine/dryer</p> <p>Set comprising:</p> <ul style="list-style-type: none"> 2 side panels (16 mm with panel support, 685 mm deep) 1 top unit with 1 hinged door 2 adjustable shelves 1 base unit 435 mm high with 1 drawer with side supports for laundry basket 1 deep drawer 1 metal plate 1 metal securing bracket 4 metal plinth feet <p><i>Panel finish:</i> <i>Panel colours</i> <i>Not available for Colour Concept support panels.</i></p> <p><i>Not available in visible side colours.</i></p> <p><i>The metal plinth feet must be installed on-site.</i></p> <p><i>Washing machine/dryer - please check whether approved for raised installation.</i></p> <p><i>Only available for plinth height 155 mm.</i></p> <p><i>The delivery comprises several packages.</i></p> <p>Safety precautions: <i>Only washing machines and tumble dryers with electronic out-of-balance control are to be used.</i> <i>The cabinet must be firmly secured to the wall.</i> <i>Only condensation and heat pump dryers are approved.</i> <i>The maximum load capacity is 130 kg, including wet laundry.</i> <i>If escaping water should cause damage from swelling in spite of using the moisture protection shield, the furniture is no longer in proper working order and must be taken out of use.</i> <i>Please follow the appliance manufacturer's conditions of installation and use.</i></p>	GWSA		63	02	436	466	500	534	621	663	718	10	16	24	4

Storage space / utility room

Panel for raised washing machine/dryer

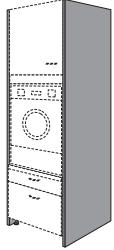

Panel for raised washing machine/dryer

floor-length with panel protector
685 mm deep
16 mm thick

460 mm high = carcass height
plus plinth height
Finish matt

1907 mm high = carcass height (01)
plus plinth height
Finish matt

2051 mm high = carcass height (02)
plus plinth height
Finish matt

WS

width

16

46

685

universal

34

WS

16

01

685

76

WS

16



02

685

80

Storage space / utility room

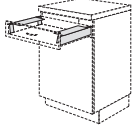
Accessories

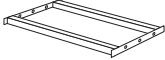
		width		universal
 <p>Laundry basket white plastic Capacity 41 litres Dimensions (H x W x D): 304 x 520 x 462 mm <i>Suitable for S 60 01 WK9 and S 60 02 WK9</i></p>	ZWK	60		19
 <p>Laundry basket support Clips onto drawer frame 2 items in set</p>	ZISA			11
 <p>Recyclable waste collector Metal housing, powder-coated Frame for recyclables bag made of plastic Swing lid made of plastic Capacity approx. 53 litres mounting to the cabinet base <i>Dimensions (H x W x D): 622 x 340 x 260 mm</i> <i>Suitable for deep drawers from 400 mm width</i></p>	ZAA	40	S	33
 <p>Supporting frames for bottle crates, individual silver-grey</p>	ZIGK	60		13

K-Line

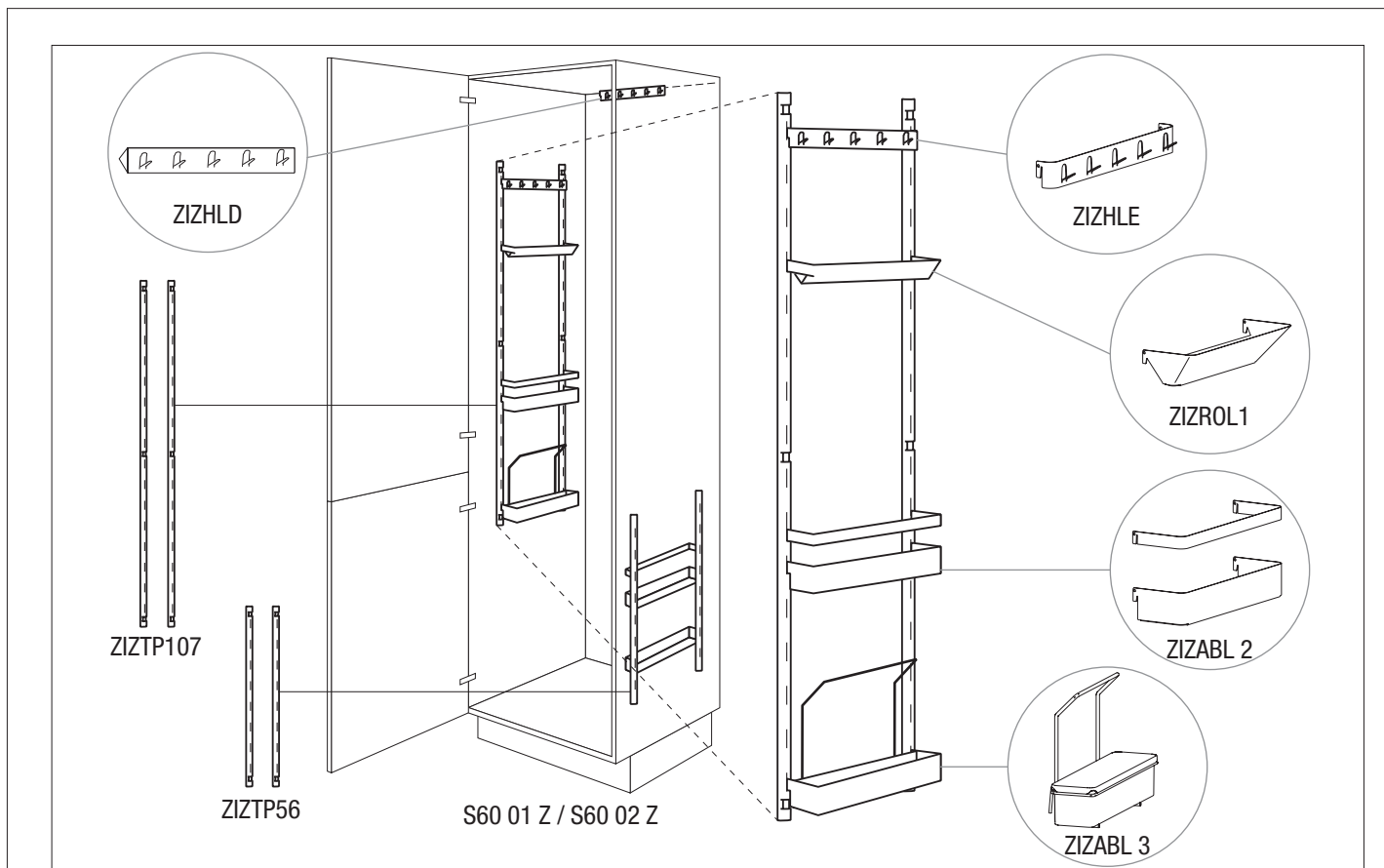

K-Line – for the clear and orderly organisation of kitchen and cleaning utensils

Practical System K-Line side was developed specifically for the storage of cleaning products and tools, and can be tailored to the user's individual requirements.









The basic element is the attachment rails, which are available in 2 lengths.

They are screwed to the carcass side on-site. The attachment rails are designed so that the practical storage surfaces, supporting rails and boxes can be suspended at individual heights.

We recommend fitting System K-Line in the tall units for individual equipping (item S60 01 Z and S60 02 Z). Naturally, the system can also be used in other cupboards such as broom cupboards.

Storage space / utility room

Accessory K-Line side

		width	universal
 <p>Fixing strips 2 items in set Length: 1073 mm silver-grey</p>		ZIZ TP 107	12
	<p>Fixing strips same as above, but Length: 560 mm</p>	ZIZ TP 56	10
 <p>Storage surface 1 each silver-grey Dimensions (W x D x H): 350 x 110 x 65 mm</p>		ZIZ ABL 1	8
 <p>Storage surface with rail 1 each silver-grey Dimensions (W x D x H): 350 x 110 x 65 mm</p>		ZIZ ABL 2	11
 <p>Carry box for cleaning agents with backing strip 1 each silver-grey Box in laminate, white Dimensions (W x D x H): 442 x 160 x 315 mm</p>		ZIZ ABL 3	15
 <p>Backing strip with box 1 each silver-grey Box in laminate, white Dimensions (W x D x H): 350 x 138 x 95 mm</p>		ZIZ ABL 4	9
 <p>Paper roll holder 1 each silver-grey Dimensions (W x D x H): 350 x 120 x 65 mm</p>		ZIZ ROL 1	8
 <p>„Rollinero“ holder with tear-off edge 1 each silver-grey Dimensions (W x D x H): 350 x 145 x 70 mm</p>		ZIZ ROL 2	16
 <p>Hanging hook rail with 5 hooks 1 each silver-grey Dimensions (W x D x H): 350 x 32 x 50 mm</p>		ZIZ HLE	6

Storage space / utility room

Accessory K-Line side

		width	universal
 <p>Hook rail to screw onto side with 5 hooks 1 each silver-grey Width: 350 mm</p>	ZIZ HLS		6
 <p>Hook rail for ceiling attachment with 5 hooks 1 each silver-grey Width: 350 mm</p>	ZIZ HLD		6
 <p>Screw-on holder for vacuum cleaner hose or PET bag 1 each silver-grey Dimensions (W x D x H): 150 x 70 x 63 mm</p>	ZIZ HSS		6
 <p>Screw-on utensils box 1 each silver-grey Dimensions (W x D x H): 255 x 140 x 300 mm</p>	ZIZ BOX 1		13



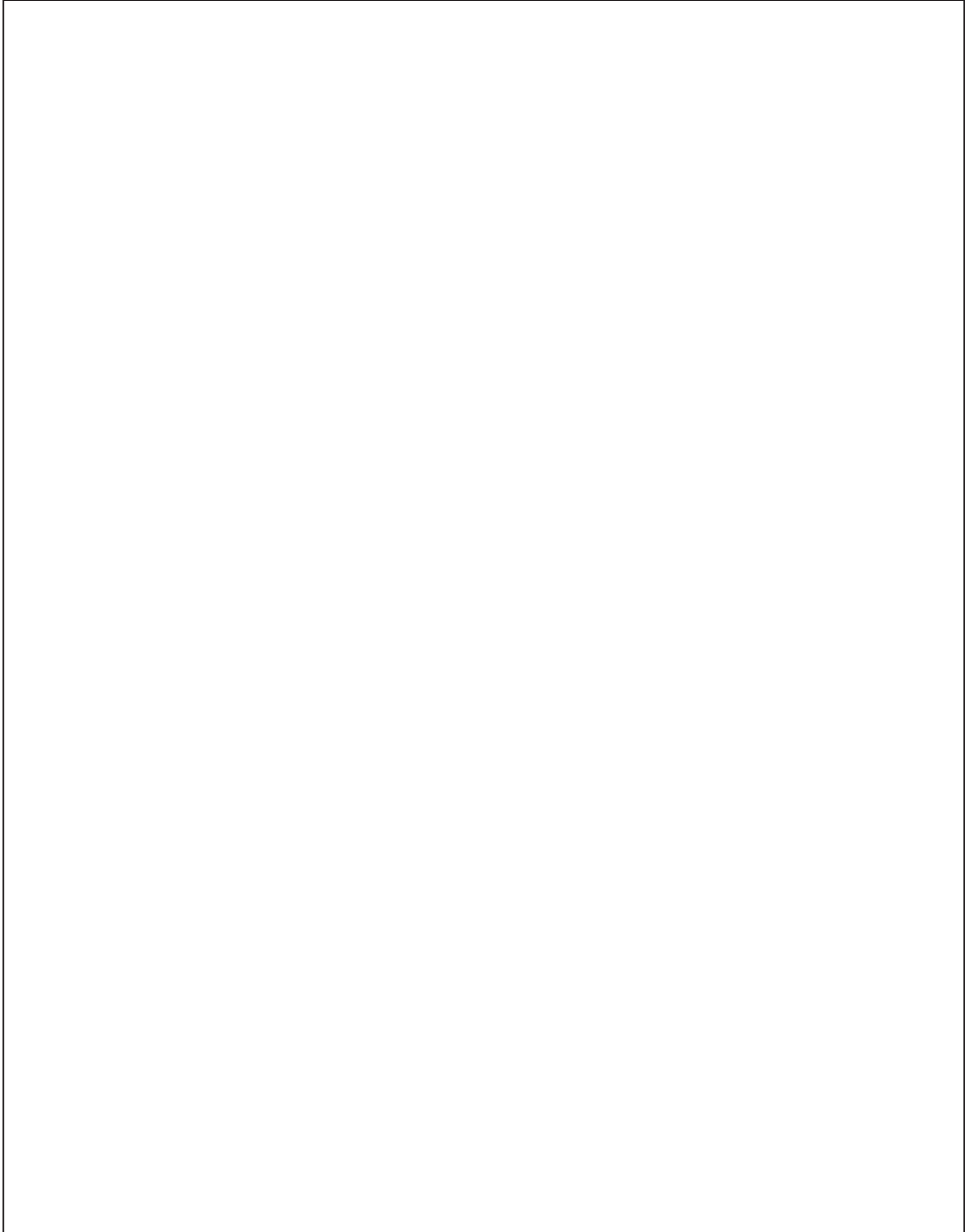

Country-house style

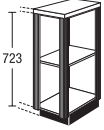
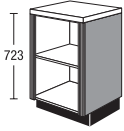

Country-house style

Country-house style

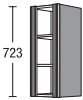
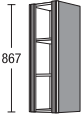
Colour Concept

		width		universal
 <p>Country house end shelf unit Shelf units 560 mm deep 1 fixed shelf <i>Planning dimension with panel 340 mm</i> <i>Planning dimension with modular panel 325 mm</i> <i>Lacquered finish.</i> <i>Available in all Colour Concept colours</i></p>	URA	30	LH	264
 <p>Country house base shelf unit 1 fixed shelf <i>Lacquered finish.</i> <i>Available in all Colour Concept colours</i></p>	UR UR	30 60	LHCK LHCK	237 282
 <p>Country house wall shelf unit 1 fixed shelf <i>Lacquered finish.</i> <i>Available in all Colour Concept colours</i></p>	HR HR	30 60	01 LH 01 LH	188 226
 <p>Country house wall shelf unit 2 fixed shelves <i>Lacquered finish.</i> <i>Available in all Colour Concept colours</i></p>	HR HR	30 60	02 LH 02 LH	213 251
 <p>Wall open shelf unit 2 fixed shelves <i>Lacquered finish.</i> <i>Available in all Colour Concept colours</i></p>	HR HR	30 60	03 LH 03 LH	226 264
 <p>Country house end shelf unit 1 fixed shelf <i>Lacquered finish.</i> <i>Available in all Colour Concept colours</i></p>	HRA	30	01 LH	205
<p>Country house end shelf unit same as above, but 2 fixed shelves <i>Lacquered finish.</i> <i>Available in all Colour Concept colours</i></p>		579 mm high = carcass height (01)		
		723 mm high = carcass height (02) 867 mm high = carcass height (03)	HRA HRA	30 02 LH 30 03 LH

Country-house style

Colour Concept

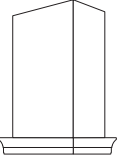
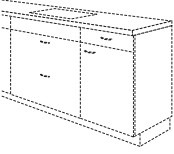
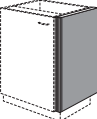
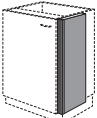
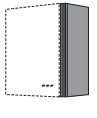
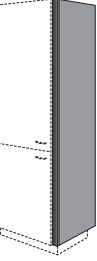
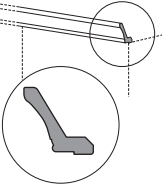
			width		universal
 <p>Chimney hood with cornice 900 mm wide, 500 mm deep For room heights up to 2600 mm Intended for independent suspension Funnel of raw chipboard, lacquered</p> <p><i>Not available in visible side colours. Cutouts for appliance to be made on site. Maximum cutout dimensions (W x D): 668 x 395 mm</i></p> <p><i>Available in all Colour Concept colours</i></p> 		HD	90	LHCK	541
 <p>Pilaster for base unit 585 mm deep 50 mm thick</p> <p><i>Lacquered finish. Available in all Colour Concept colours</i></p>	723 mm high = carcass height plus plinth height Finish matt	PIU		72	83
 <p>Pilaster for base unit 351 mm deep 50 mm thick</p> <p><i>Lacquered finish. Available in all Colour Concept colours</i></p>	723 mm high = carcass height plus plinth height Finish matt	PILU		72	56
 <p>Pilaster for wall unit 351 mm deep 50 mm thick</p> <p><i>Lacquered finish. Available in all Colour Concept colours</i></p>	579 mm high = carcass height (01) 723 mm high = carcass height (02) 867 mm high = carcass height (03)	PIH PIH PIH		01 02 03	48 56 64
 <p>Pilaster for highboard / tall unit 585 mm depth 50 mm thick</p> <p><i>Lacquered finish. Available in all Colour Concept colours</i></p>	1043 mm high = carcass height 1475 mm high = carcass height 1619 mm high = carcass height 1907 mm high = carcass height (01) 2051 mm high = carcass height (02) 2195 mm high = carcass height (03)	PIS PIS PIS PIS PIS PIS		104 148 162 01 02 03	114 155 169 197 210 224
 <p>Country house cornice Height: 78 mm</p> <p><i>Carcass projection at front: 58 mm Price incl. mitre cuts</i></p> <p><i>Maximum length without join: 3600 mm</i></p> <p><i>Available according to sketch.</i></p> <p><i>Calculated per mm</i></p> <p><i>Lacquered finish. Available in all Colour Concept colours</i></p>	per metre	K78		CK	36

Country-house style

Colour Concept

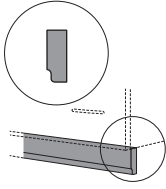
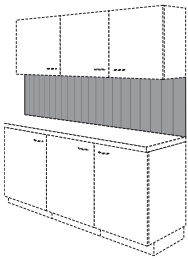
			width		universal	
	<p>Country house light pelmet</p> <p>Height: 50 mm</p> <p><i>Maximum length without join: 3600 mm</i> <i>Available according to sketch.</i></p> <p><i>Price incl. mitre cuts</i> <i>Calculated per mm</i></p> <p><i>Lacquered finish.</i> <i>Available in all Colour Concept colours</i></p>	per metre	LB50	CK	27	
	<p>Country house light pelmet</p> <p>for flat extractors</p> <p><i>Lacquered finish.</i> <i>Available in all Colour Concept colours</i></p>	for 60cm telescopic hood	LB50	60	CK	17
		for 90cm telescopic hood	LB50	90	CK	23
	<p>Recess back panel with groove profile</p> <p>between worktop and wall units, approx. 16 mm thick 565 mm high, 150-2600 mm wide</p> <p><i>Lacquered finish.</i> <i>Available in all Colour Concept colours</i></p> <p><i>In case of uneven wall, a flat surface must be prepared beforehand.</i></p> <p><i>A minimum distance of 100 mm must be maintained between gas hobs and niche back panels.</i></p> <p><i>The material thickness of the combi-sealer strip (5 mm) on the worktop must be taken into account when using a combi-sealer strip.</i></p> <p><i>The material thickness of the sealer strip (5 mm) must be taken into account for the niche height when using a sealer strip.</i></p> <p><i>Calculated per mm</i></p>	per metre	NR	565	LHCK	71
	<p>Recess back panel with groove profile</p> <p>same as above, but between 25 mm worktop and wall units approx. 16 mm thick 580 mm high, 150-2600 mm wide</p> <p><i>Calculated per mm</i></p>	per metre	NR	580	LHCK	76

Country-house style

Foil-wrapped

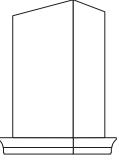
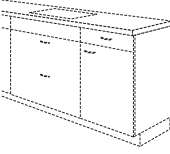
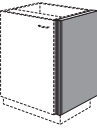
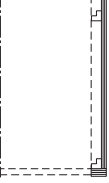
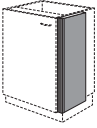
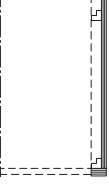
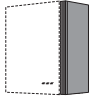
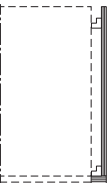
			width		universal
 <p>Chimney hood with cornice 900 mm wide, 500 mm deep For room heights up to 2600 mm Intended for independent suspension Funnel in carcass material</p> <p><i>Not available in visible side colours. Cutouts for appliance to be made on site. Maximum cutout dimensions (W x D): 668 x 395 mm</i></p> <p><i>Colour finish: IP 4250, white No. 786 IP 4250, magnolia white No. 787 IP 4250, graphite No. 956 IP 4250, space grey no. 957</i></p> 		HD	90	LH	366
 <p>Pilaster for base unit 585 mm deep 50 mm thick</p> <p><i>Pilaster open on one side.</i></p> <p><i>Foil-wrapped finish Available in IP 4250, white No. 786 IP 4250, magnolia white No. 787 IP 4250, graphite No. 956 IP 4250, space grey no. 957</i></p> 	723 mm high = carcass height plus plinth height Finish matt	PIU	72	F	69
 <p>Pilaster for base unit 351 mm deep 50 mm thick</p> <p><i>Pilaster strip open on one side.</i></p> <p><i>Foil-wrapped finish Available in IP 4250, white No. 786 IP 4250, magnolia white No. 787 IP 4250, graphite No. 956 IP 4250, space grey no. 957</i></p> 	723 mm high = carcass height plus plinth height Finish matt	PILU	72	F	54
 <p>Pilaster for wall unit 351 mm deep 50 mm thick</p> <p><i>Pilaster open on one side.</i></p> <p><i>Foil-wrapped finish Available in IP 4250, white No. 786 IP 4250, magnolia white No. 787 IP 4250, graphite No. 956 IP 4250, space grey no. 957</i></p> 	579 mm high = carcass height (01) 723 mm high = carcass height (02) 867 mm high = carcass height (03)	PIH PIH PIH	01 02 03	F F F	47 55 63

Country-house style

Foil-wrapped

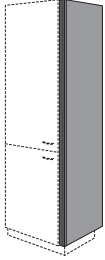
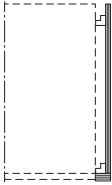
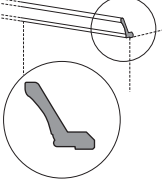
			width	universal	
 <p>Pilaster for highboard / tall unit 585 mm deep 50 mm thick</p> <p><i>Pilaster open on one side.</i></p> <p><i>Foil-wrapped finish</i> <i>Available in</i> <i>IP 4250, white No. 786</i> <i>IP 4250, magnolia white No. 787</i> <i>IP 4250, graphite No. 956</i> <i>IP 4250, space grey no. 957</i></p> 	1043 mm high = carcass height	PIS	104	F	81
	1475 mm high = carcass height	PIS	148	F	111
	1619 mm high = carcass height	PIS	162	F	122
	1907 mm high = carcass height (01)	PIS	01	F	143
	2051 mm high = carcass height (02)	PIS	02	F	153
	2195 mm high = carcass height (03)	PIS	03	F	163
 <p>Country house cornice Height: 78 mm</p> <p><i>Carcass projection at front: 58 mm</i> <i>Price incl. mitre cuts</i></p> <p><i>Maximum length without join: 3600 mm</i></p> <p><i>Available according to sketch.</i></p> <p><i>Foil-wrapped finish</i></p> <p><i>Available in</i> <i>IP 4250, white No. 786</i> <i>IP 4250, magnolia white No. 787</i> <i>IP 4250, graphite No. 956</i> <i>IP 4250, space grey no. 957</i></p>	per metre	K78		F	27

Country-house style

Foil-wrapped

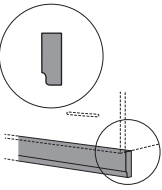
			width		universal
 <p>Country house light pelmet Height: 50 mm</p> <p><i>Maximum length without join: 3600 mm Available according to sketch.</i></p> <p><i>Price incl. mitre cuts Calculated per mm</i></p> <p><i>Foil-wrapped finish Available in IP 4250, white No. 786 IP 4250, magnolia white No. 787 IP 4250, graphite No. 956 IP 4250, space grey no. 957</i></p>	per metre	LB50		F	22
	for 60cm telescopic hood	LB50	60	F	13
	for 90cm telescopic hood	LB50	90	F	17

Individual parts

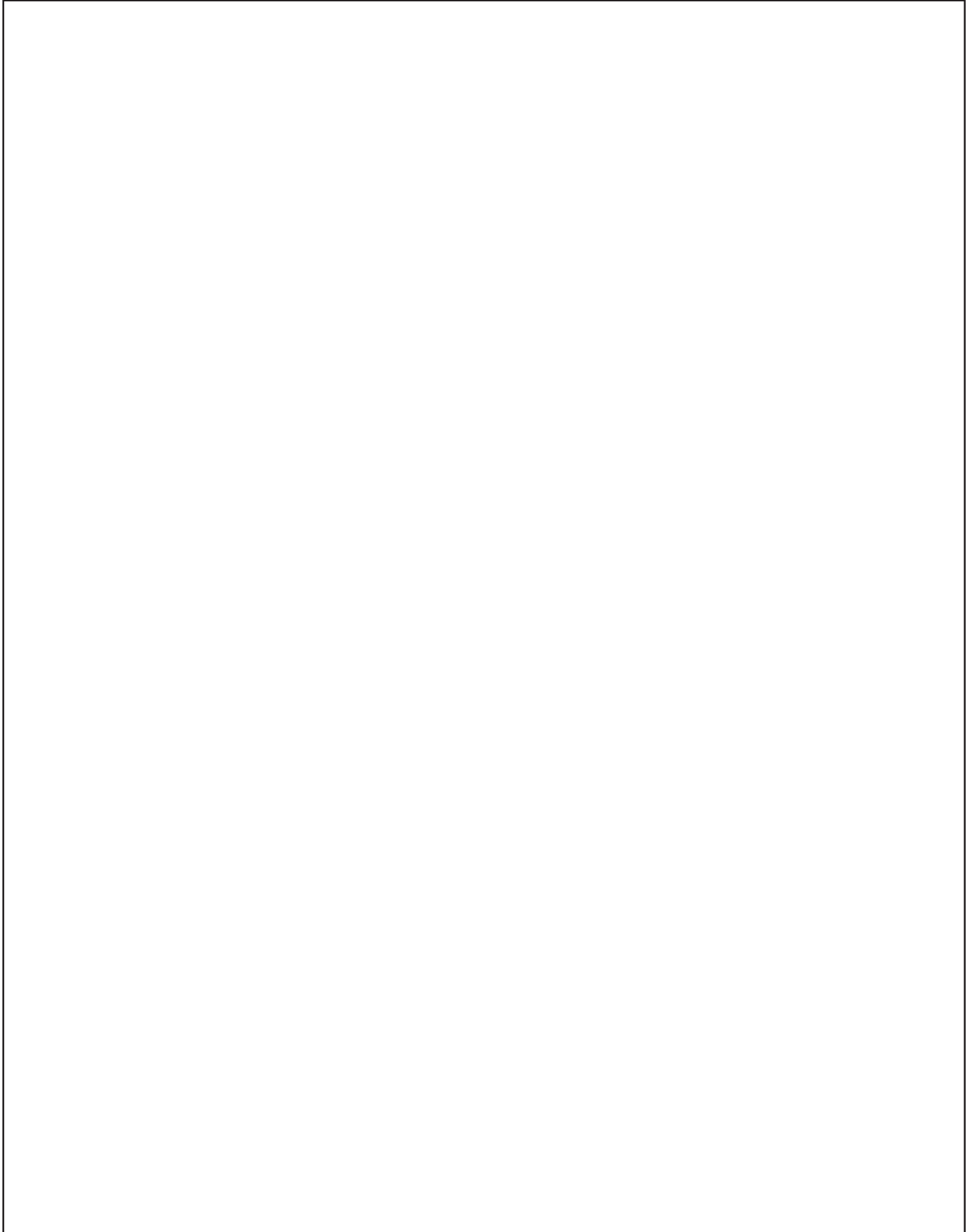

Individual parts

Individual parts









Single parts for base units

		width	Price group							Servosoft	Pro Servosoft	ProServoglass	Soft closing Top Motion	Soft closing Top Motion Plus	
			1	2	3	4	5	6	7						
Hinged door with fittings for base units with drawer Height: 573 mm	ETU	30	58	14	17	18	20	26	29	34	-	-	-	4	4
	ETU	40	58	15	18	20	22	28	32	37	-	-	-	4	4
	ETU	45	58	16	19	21	23	29	34	40	-	-	-	4	4
	ETU	50	58	18	21	23	25	31	36	43	-	-	-	4	4
	ETU	60	58	19	22	24	26	33	39	47	-	-	-	4	4
Hinged door with fittings for base units without drawers and tall units Height: 717 mm	ETU	30	72	20	23	24	26	32	35	40	-	-	-	4	4
	ETU	40	72	21	24	26	28	34	38	43	-	-	-	4	4
	ETU	45	72	21	24	26	29	36	40	45	-	-	-	4	4
	ETU	50	72	22	25	27	30	37	42	49	-	-	-	4	4
	ETU	60	72	23	27	29	32	38	44	52	-	-	-	4	4
Door without hinges and drillings Height: 717 mm	ET	30	72	19	22	23	25	31	34	39	-	-	-	-	-
	ET	40	72	20	23	25	27	33	37	42	-	-	-	-	-
	ET	45	72	20	23	25	28	35	41	44	-	-	-	-	-
	ET	50	72	21	24	26	29	36	41	48	-	-	-	-	-
	ET	60	72	22	26	28	31	37	43	51	-	-	-	-	-
Front without hinges or drill holes for corner base unit UE 80 KP / UE 80 K Height: 717 mm	ETUE	20	72	L	14	16	18	20	25	28	32	-	-	-	-
	ETUE	20	72	R	15	17	19	21	26	29	33	-	-	-	-
Front without hinges or drill holes for corner base unit UE 90 KP / UE 90 K Height: 717 mm	ETUE	30	72	L	15	17	19	22	26	30	34	-	-	-	-
	ETUE	30	72	R	16	18	20	23	27	31	35	-	-	-	-
Hinged door with fittings for base units Height: 861 mm	ETU	50	87	27	30	33	36	44	57	70	-	-	-	4	4
	ETU	60	87	28	32	35	38	47	58	71	-	-	-	4	4
Front panel for base units with built-in cooker Height: 118 mm for UHB	EB	60	12	8	11	12	13	15	16	19	-	-	-	-	-
	EB	60	12	W	20	23	23	24	26	28	32	-	-	-	-
Front panel as above for UHSW	EB	60	12	W	20	23	23	24	26	28	32	-	-	-	-
	EB	60	12	W	20	23	23	24	26	28	32	-	-	-	-
Flap door with hinges for UHK Height: 118 mm	EK	60	12	17	20	21	22	24	26	29	-	-	-	4	14
Drawer front for UHS Height: 118 mm	ESV	60	12	NZ	10	13	14	15	16	18	21	-	-	-	-



Single parts for base units

		width	Price group							Servosoft	Pro Servosoft	ProServoGlass	Soft closing Top Motion	Soft closing Top Motion Plus	
			1	2	3	4	5	6	7						
Deep drawer complete, but without runners Height: 285 mm	EA	30		24	27	29	31	36	39	44	2	5	13	-	-
	EA	40		27	30	32	34	39	42	47	2	5	13	-	-
	EA	45		28	31	33	35	40	43	48	2	5	13	-	-
	EA	50		30	33	35	37	42	46	50	2	5	13	-	-
	EA	60		32	35	37	40	45	49	55	2	5	13	-	-
	EA	80		41	44	46	49	54	58	64	3	6	14	-	-
	EA	90		42	45	47	50	55	59	65	3	6	14	-	-
	EA	100		44	47	49	52	57	61	67	3	6	14	-	-
	EA	120		58	62	65	69	75	80	88	3	6	14	-	-
Deep drawer front Height: 285 mm	EAV	30		12	15	16	18	23	26	31	-	-	-	-	-
	EAV	40		13	16	17	19	25	28	33	-	-	-	-	-
	EAV	45		14	17	18	20	26	29	34	-	-	-	-	-
	EAV	50		15	18	19	21	27	30	35	-	-	-	-	-
	EAV	60		16	19	21	23	29	33	38	-	-	-	-	-
	EAV	80		20	23	25	27	32	36	42	-	-	-	-	-
	EAV	90		22	25	27	30	35	40	46	-	-	-	-	-
	EAV	100		23	26	28	31	36	41	47	-	-	-	-	-
	EAV	120		24	27	29	32	38	43	49	-	-	-	-	-
Deep drawer without front 270 mm deep	EAOV	30	27	35	35	35	35	35	35	35	3	6	14	-	-
	EAOV	40	27	36	36	36	36	36	36	36	3	6	14	-	-
	EAOV	45	27	36	36	36	36	36	36	36	3	6	14	-	-
	EAOV	50	27	37	37	37	37	37	37	37	3	6	14	-	-
	EAOV	60	27	38	38	38	38	38	38	38	3	6	14	-	-
	EAOV	80	27	39	39	39	39	39	39	39	3	6	14	-	-
	EAOV	90	27	43	43	43	43	43	43	43	3	6	14	-	-
	EAOV	100	27	47	47	47	47	47	47	47	3	6	14	-	-
	EAOV	120	27	51	51	51	51	51	51	51	3	6	14	-	-
Deep drawer without front depth 400 mm	EAOV	30	40	35	35	35	35	35	35	35	3	6	14	-	-
	EAOV	40	40	36	36	36	36	36	36	36	3	6	14	-	-
	EAOV	45	40	36	36	36	36	36	36	36	3	6	14	-	-
	EAOV	50	40	37	37	37	37	37	37	37	3	6	14	-	-
	EAOV	60	40	38	38	38	38	38	38	38	3	6	14	-	-
	EAOV	80	40	39	39	39	39	39	39	39	3	6	14	-	-
	EAOV	90	40	43	43	43	43	43	43	43	3	6	14	-	-
	EAOV	100	40	47	47	47	47	47	47	47	3	6	14	-	-
	EAOV	120	40	51	51	51	51	51	51	51	3	6	14	-	-
Deep drawer without front 500 mm deep	EAOV	30		14	14	14	14	14	14	14	3	6	14	-	-
	EAOV	40		15	15	15	15	15	15	15	3	6	14	-	-
	EAOV	45		16	16	16	16	16	16	16	3	6	14	-	-
	EAOV	50		17	17	17	17	17	17	17	3	6	14	-	-
	EAOV	60		19	19	19	19	19	19	19	3	6	14	-	-
	EAOV	80		26	26	26	26	26	26	26	3	6	14	-	-
	EAOV	90		30	30	30	30	30	30	30	3	6	14	-	-
	EAOV	100		34	34	34	34	34	34	34	3	6	14	-	-
	EAOV	120		38	38	38	38	38	38	38	3	6	14	-	-
Drawer complete, but without runners Height: 141 mm	ES	30		19	22	23	24	25	26	29	2	5	13	-	-
	ES	40		20	23	24	25	26	27	30	2	5	13	-	-
	ES	45		20	23	24	25	26	27	30	2	5	13	-	-
	ES	50		21	24	25	26	27	29	33	2	5	13	-	-
	ES	60		22	25	26	27	29	31	34	2	5	13	-	-
	ES	80		36	39	40	41	43	45	48	2	5	13	-	-
	ES	90		38	41	42	43	45	47	51	2	5	13	-	-
	ES	100		39	42	43	44	46	49	55	2	5	13	-	-
	ES	120		42	45	46	47	50	53	59	2	5	13	-	-

Single parts for base units

		width	Price group							Servosoft	Pro Servosoft	ProServodglass	Soft closing Top Motion	Soft closing Top Motion Plus	
			1	2	3	4	5	6	7						
Drawer front Height: 141 mm	ESV	30		7	10	11	12	13	14	16	-	-	-	-	-
	ESV	40		8	11	12	13	14	16	18	-	-	-	-	-
	ESV	45		8	11	12	13	14	16	18	-	-	-	-	-
	ESV	50		9	12	13	14	15	17	20	-	-	-	-	-
	ESV	60		10	13	14	15	16	18	21	-	-	-	-	-
	ESV	80		11	14	15	16	17	19	22	-	-	-	-	-
	ESV	90		12	15	16	17	18	20	23	-	-	-	-	-
	ESV	100		13	16	17	18	19	21	24	-	-	-	-	-
	ESV	120		14	17	18	19	20	23	26	-	-	-	-	-
Drawer without front panel 500 mm deep	ESOV	30		13	13	13	13	13	13	13	2	5	13	-	-
	ESOV	40		14	14	14	14	14	14	14	2	5	13	-	-
	ESOV	45		15	15	15	15	15	15	15	2	5	13	-	-
	ESOV	50		16	16	16	16	16	16	16	2	5	13	-	-
	ESOV	60		18	18	18	18	18	18	18	2	5	13	-	-
	ESOV	80		23	23	23	23	23	23	23	3	6	14	-	-
	ESOV	90		24	24	24	24	24	24	24	3	6	14	-	-
	ESOV	100		26	26	26	26	26	26	26	3	6	14	-	-
	ESOV	120		28	28	28	28	28	28	28	3	6	14	-	-
Drawer without front panel 270 mm deep	ESOV	30	27	25	25	25	25	25	25	25	2	5	13	-	-
	ESOV	40	27	26	26	26	26	26	26	26	2	5	13	-	-
	ESOV	45	27	26	26	26	26	26	26	26	2	5	13	-	-
	ESOV	50	27	27	27	27	27	27	27	27	2	5	13	-	-
	ESOV	60	27	28	28	28	28	28	28	28	2	5	13	-	-
	ESOV	80	27	34	34	34	34	34	34	34	3	6	13	-	-
	ESOV	90	27	38	38	38	38	38	38	38	3	6	13	-	-
	ESOV	100	27	42	42	42	42	42	42	42	3	6	14	-	-
	ESOV	120	27	46	46	46	46	46	46	46	3	6	14	-	-
Drawer without front panel depth 400 mm	ESOV	30	40	30	30	30	30	30	30	30	2	5	13	-	-
	ESOV	40	40	31	31	31	31	31	31	31	2	5	13	-	-
	ESOV	45	40	31	31	31	31	31	31	31	2	5	13	-	-
	ESOV	50	40	32	32	32	32	32	32	32	2	5	13	-	-
	ESOV	60	40	33	33	33	33	33	33	33	2	5	13	-	-
	ESOV	80	40	34	34	34	34	34	34	34	3	6	14	-	-
	ESOV	90	40	38	38	38	38	38	38	38	3	6	14	-	-
	ESOV	100	40	42	42	42	42	42	42	42	3	6	14	-	-
	ESOV	120	40	46	46	46	46	46	46	46	3	6	14	-	-
 Carcass tracks, full extension with Servosoft for drawers	404 720 right			7	7	7	7	7	7	7	-	-	-	-	-
	404 721 left			7	7	7	7	7	7	7	-	-	-	-	-
Interior drawer <i>Carcass tracks must be ordered separately.</i> <i>Hinges with an opening angle of 155° are required for installing behind hinged doors.</i>	EIS	30		20	20	20	20	20	20	20	2	5	13	-	-
	EIS	45		21	21	21	21	21	21	21	2	5	13	-	-
	EIS	50		22	22	22	22	22	22	22	2	5	13	-	-
	EIS	60		23	23	23	23	23	23	23	2	5	13	-	-
	EIS	80		26	26	26	26	26	26	26	2	5	13	-	-
	EIS	90		26	26	26	26	26	26	26	2	5	13	-	-
	EIS	100		32	32	32	32	32	32	32	2	5	13	-	-
	EIS	120		36	36	36	36	36	36	36	2	5	13	-	-
Interior drawer including carcass runners <i>Hinges with an opening angle of 155° are required for installing behind hinged doors.</i>	 EIS	30	SET	33	33	33	33	33	33	33	2	5	13	-	-
	 EIS	45	SET	34	34	34	34	34	34	34	2	5	13	-	-
	 EIS	50	SET	35	35	35	35	35	35	35	2	5	13	-	-
	 EIS	60	SET	36	36	36	36	36	36	36	2	5	13	-	-
	 EIS	80	SET	39	39	39	39	39	39	39	2	5	13	-	-
	 EIS	90	SET	39	39	39	39	39	39	39	2	5	13	-	-
	 EIS	100	SET	45	45	45	45	45	45	45	2	5	13	-	-
	 EIS	120	SET	49	49	49	49	49	49	49	2	5	13	-	-

Single parts for base units

		width		Price group							Servosoft	Pro Servosoft	ProServoGlass	Soft closing Top Motion	Soft closing Top Motion Plus
				1	2	3	4	5	6	7					
Interior deep drawer <i>Carcase tracks must be ordered separately.</i> <i>Hinges with an opening angle of 155° are required for installing behind hinged doors.</i>	EIA	30		22	22	22	22	22	22	22	2	5	13	-	-
	EIA	45		23	23	23	23	23	23	23	2	5	13	-	-
	EIA	50		24	24	24	24	24	24	24	2	5	13	-	-
	EIA	60		26	26	26	26	26	26	26	2	5	13	-	-
Interior deep drawer including carcass runners NEW NEW <i>Hinges with an opening angle of 155° are required for installing behind hinged doors.</i> NEW NEW	EIA	30	SET	35	35	35	35	35	35	35	2	5	13	-	-
	EIA	45	SET	36	36	36	36	36	36	36	2	5	13	-	-
	EIA	50	SET	37	37	37	37	37	37	37	2	5	13	-	-
	EIA	60	SET	39	39	39	39	39	39	39	2	5	13	-	-
 Hinge with 155° opening angle <i>Required for units with side-mounted door and interior drawers</i>	404 645			4	4	4	4	4	4	4	-	-	-	-	-
	404 712		with Top Motion	6	6	6	6	6	6	6	-	-	-	-	-
 Clip hinge, 107° opening angle <small>Ill. shows 404 706</small>	404 706		without cushioning	2	2	2	2	2	2	2	-	-	-	-	-
	404 711		with Top Motion	4	4	4	4	4	4	4	-	-	-	-	-
 Cross-plate for clip-on hinge for follow-up orders	404 404			1	1	1	1	1	1	1	-	-	-	-	-
Bumper bar transparent	SL29			4	4	4	4	4	4	4	-	-	-	-	-
	SL43			4	4	4	4	4	4	4	-	-	-	-	-
	SL58			5	5	5	5	5	5	5	-	-	-	-	-
	SL72			5	5	5	5	5	5	5	-	-	-	-	-
	SL87			6	6	6	6	6	6	6	-	-	-	-	-
Metal cross member white 1 each	TRAV	120	M	20	20	20	20	20	20	20	-	-	-	-	-

Single parts for tall units

		width	Price group							Servosoft	Pro Servosoft	ProServoglass	Soft closing Top Motion	Soft closing Top Motion Plus		
			1	2	3	4	5	6	7							
Upper hinged door with fittings Dowel drilling at bottom Height: 1181 mm	ETHD	45	118	31	34	37	40	50	59	71	-	-	-	6	6	
	ETHD	50	118	31	36	39	42	51	61	73	-	-	-	6	6	
	ETHD	60	118	37	40	43	47	55	73	96	-	-	-	6	6	
	Lower hinged-door with hinges Dowel drilling at top Height: 717 mm	ETUD	45	72	21	24	25	27	36	40	45	-	-	-	4	4
		ETUD	50	72	22	24	26	29	37	42	49	-	-	-	4	4
		ETUD	60	72	23	27	29	32	38	44	52	-	-	-	4	4
	Upper hinged door with fittings Height: 1181 mm	ETH	45	118	31	34	37	40	50	59	71	-	-	-	6	6
		ETH	50	118	32	38	40	42	51	61	73	-	-	-	6	6
		ETH	60	118	37	40	43	47	55	73	96	-	-	-	6	6
Unit rear panel Hardboard, white on one side		RWS	60	119	6	6	6	6	6	6	6	-	-	-	-	-
		RWS	60	148	8	8	8	8	8	8	8	-	-	-	-	-
		RWS	60	191	10	10	10	10	10	10	10	-	-	-	-	-
		RWS	60	205	11	11	11	11	11	11	11	-	-	-	-	-
		RWS	60	219	12	12	12	12	12	12	12	-	-	-	-	-
		RWS	60	30	3	3	3	3	3	3	3	-	-	-	-	-
		RWS	60	37	4	4	4	4	4	4	4	-	-	-	-	-
		RWS	60	44	6	6	6	6	6	6	6	-	-	-	-	-
		RWS	60	58	6	6	6	6	6	6	6	-	-	-	-	-
		RWS	60	73	7	7	7	7	7	7	7	-	-	-	-	-
RWS		60	87	8	8	8	8	8	8	8	-	-	-	-	-	
Hinged door with fittings For tall units / highboards Height: 1469 mm		ETH	30	148	33	39	40	41	55	65	75	-	-	-	6	6
		ETH	60	148	47	50	52	54	65	85	108	-	-	-	6	6
Hinged door with fittings For tall units / highboards Height: 1469 mm		ETH	45	148	44	47	49	52	63	82	104	-	-	-	6	6
		ETH	50	148	45	48	50	53	65	84	107	-	-	-	6	6
<i>Available for the following ranges: IP 1200, IP 2200, IP 3150, IP 4050</i>																

Single parts for wall units

		width		Price group							Servosoft	Pro Servosoft	ProServoGlass	Soft closing Top Motion	Soft closing Top Motion Plus
				1	2	3	4	5	6	7					
Hinged door with fittings for wall units 867 mm high Height: 861 mm	ETH	30	87	23	27	30	33	42	53	66	-	-	-	4	4
	ETH	40	87	24	28	31	34	43	54	67	-	-	-	4	4
	ETH	45	87	25	29	32	35	44	55	68	-	-	-	4	4
	ETH	50	87	27	31	34	37	46	57	70	-	-	-	4	4
	ETH	60	87	28	32	35	38	47	58	71	-	-	-	4	4
Hinged door with fittings for wall units 723 mm high Height: 717 mm	ETH	30	72	19	22	24	27	35	44	55	-	-	-	4	4
	ETH	40	72	20	23	25	28	36	45	56	-	-	-	4	4
	ETH	45	72	21	24	26	29	37	46	57	-	-	-	4	4
	ETH	50	72	23	26	28	31	39	48	59	-	-	-	4	4
	ETH	60	72	24	27	29	32	40	49	60	-	-	-	4	4
Hinged door with fittings for wall units 579 mm high Height: 573 mm	ETH	30	58	14	17	18	20	26	29	34	-	-	-	4	4
	ETH	40	58	15	18	20	22	28	33	39	-	-	-	4	4
	ETH	45	58	16	19	21	23	29	34	40	-	-	-	4	4
	ETH	50	58	18	21	23	25	31	36	43	-	-	-	4	4
	ETH	60	58	19	22	24	26	33	39	47	-	-	-	4	4
Glass door with fittings for wall units 867 mm high Height: 861 mm <i>Assembly of handles nos. 740, 760, 780, 790 and 800 only horizontal, centred</i> <i>For glass and frame finishes please refer to programme summary</i>	ETHG	45	87	61	65	66	68	77	86	98	-	-	-	4	4
	ETHG	50	87	62	66	68	70	80	90	103	-	-	-	4	4
	ETHG	60	87	64	70	72	74	86	95	108	-	-	-	4	4
Glass door with fittings for wall units 723 mm high Height: 717 mm <i>Assembly of handles nos. 740, 760, 780, 790 and 800 only horizontal, centred</i> <i>For glass and frame finishes please refer to programme summary</i>	ETHG	45	72	57	61	62	64	72	79	89	-	-	-	4	4
	ETHG	50	72	58	62	63	65	74	82	92	-	-	-	4	4
	ETHG	60	72	60	65	66	68	78	86	97	-	-	-	4	4
Glass door with fittings for wall units 579 mm high Height: 573 mm <i>Assembly of handles nos. 740, 760, 780, 790 and 800 only horizontal, centred</i> <i>For glass and frame finishes please refer to programme summary</i>	ETHG	45	58	52	56	57	59	66	71	78	-	-	-	4	4
	ETHG	50	58	53	57	58	60	67	73	81	-	-	-	4	4
	ETHG	60	58	55	59	60	62	69	76	86	-	-	-	4	4
Doors with fittings for HE 65 01 Height: 573 mm Doors with fittings for HE 65 02 Height: 717 mm Doors with fittings for HE 65 03 Height: 861 mm	ETHE	65	58	36	39	43	47	58	65	74	-	-	-	4	4
	ETHE	65	72	47	52	56	61	72	85	101	-	-	-	4	4
	ETHE	65	87	58	65	70	75	86	104	127	-	-	-	4	4

Single parts for wall units

		width		Price group							Servosoft	Pro Servosoft	ProServoGlass	Soft closing Top Motion	Soft closing Top Motion Plus
				1	2	3	4	5	6	7					
Flap door with hinges Height: 285 mm	EK	45	29	19	22	23	25	31	34	39	-	-	-	4	14
	EK	50	29	20	23	24	26	32	35	40	-	-	-	4	14
	EK	60	29	21	24	26	28	34	38	43	-	-	-	4	14
	EK	80	29	25	28	31	34	42	45	51	-	-	-	4	14
	EK	90	29	29	33	36	40	50	54	61	-	-	-	4	14
	EK	100	29	31	35	39	43	54	58	65	-	-	-	4	14
Flap door with hinges Height: 357 mm	EK	50	36	20	23	25	27	31	36	41	-	-	-	4	14
	EK	60	36	24	28	30	32	38	44	50	-	-	-	4	14
	EK	80	36	31	35	39	43	54	58	65	-	-	-	4	14
	EK	90	36	32	36	40	44	55	60	68	-	-	-	4	14
	EK	100	36	33	37	42	46	58	62	69	-	-	-	4	14

Individual front parts for cut

		width	Price group							Servosoft	Pro Servosoft	ProServoGlass	Soft closing Top Motion	Soft closing Top Motion Plus
			1	2	3	4	5	6	7					
<p>Front without drill holes</p> <p>Various sizes Height: 118 - 285 mm Width: 144 - 894 mm</p> <p><i>Available for the following ranges: IP 1200, IP 2200, IP 3150, IP 4050</i></p>	ETV	1	28	31	34	38	46	52	59	-	-	-	-	-
<p>Front without drill holes</p> <p>same as above, but Height: 286 - 717 mm Width: 144 - 594 mm</p> <p><i>Available for the following ranges: IP 1200, IP 2200, IP 3150, IP 4050</i></p>	ETV	2	29	33	36	40	49	55	62	-	-	-	-	-
<p>Front without drill holes</p> <p>same as above, but Height: 718 - 1469 mm Width: 144 - 594 mm</p> <p><i>Available for the following ranges: IP 1200, IP 2200, IP 3150, IP 4050</i></p>	ETV	3	54	57	62	66	72	78	86	-	-	-	-	-
<p>Front without drill holes <small>NEW</small></p> <p>same as above, but Height: 718 - 1469 mm Width: 144 - 756 mm</p> <p><i>Available for the following ranges: IP 1200, IP 2200, IP 3150, IP 4050</i></p>	ETV	4	56	59	64	68	75	81	89	-	-	-	-	-





Surcharges/miscellaneous

--

Surcharges/miscellaneous

Surcharges/miscellaneous

Surcharges/miscellaneous

		width	universal
<p> Surcharge for width reduction For base units with drawer / hinged door per unit Width reduction to 300 mm wide possible. <i>Reduction only available for reducible ranges with edging finish.</i> <i>Available ranges:</i> <i>IP 1200, IP 2200, IP 3150, IP 4050</i> <i>Bar handles and grip ledges are not possible with width reductions.</i></p>	ZUSBREITU1		83
<p> Surcharge for width reduction For base units with pull-outs / hinged doors per unit Width reduction to 300 mm wide possible. <i>Reduction only available for reducible ranges with edging finish.</i> <i>Available ranges:</i> <i>IP 1200, IP 2200, IP 3150, IP 4050</i> <i>Bar handles and grip ledges are not possible with width reductions.</i></p>	ZUSBREITU2		150
<p> Surcharge for width reduction Range C For base units with drawer / hinged door per unit Width reduction to 300 mm wide possible.</p>	ZUSBREITCU1		110
<p> Surcharge for width reduction Range C For base units with pull-outs / hinged doors per unit Width reduction to 300 mm wide possible.</p>	ZUSBREITCU2		177
<p> Surcharge for width reduction For wall units per unit Width reduction to 300 mm wide possible. <i>Reduction only available for reducible ranges with edging finish.</i> <i>Available ranges:</i> <i>IP 1200, IP 2200, IP 3150, IP 4050</i> <i>Bar handles and grip ledges are not possible with width reductions.</i></p>	ZUSBREITH		61

Surcharges/miscellaneous

		width	universal
↔	<p>Surcharge for width reduction</p> <p>For tall units / highboards per unit</p> <p>Width reduction to 300 mm wide possible.</p> <p><i>Reduction only available for reducible ranges with edging finish.</i></p> <p><i>Available ranges:</i> IP 1200, IP 2200, IP 3150, IP 4050</p> <p><i>Bar handles and grip ledges are not possible with width reductions.</i></p>	ZUSBREITS	80
↔	<p>Surcharge for width reduction Range C</p> <p>For tall units / highboards per unit</p> <p>Width reduction to 300 mm wide possible.</p>	ZUSBREITCS	107
↔	<p>Surcharge for width reduction</p> <p>For individual parts of a unit (except carcass) Per individual part</p> <p>Width reduction to 300 mm wide possible.</p> <p><i>Reduction only available for reducible ranges with edging finish.</i></p> <p><i>Available ranges:</i> IP 1200, IP 2200, IP 3150, IP 4050</p> <p><i>Bar handles and grip ledges are not possible with width reductions.</i></p>	ZUSBREITET	53
✂	<p>Surcharge for depth reduction</p> <p>per unit</p> <p><i>Cabinet accessories may not be required where depth is shortened and must be ordered separately.</i></p> <p><i>Size reduction for standard range:</i> <i>Base units / highboards / tall units</i> <i>- with hinged door: 559 to 250 mm</i></p> <p><i>- with drawer / pull-out:</i> <i>559 to 440 mm = drawer / pull-out depth 400 mm</i> <i>439 to 310 mm = drawer / pull-out depth 270 mm</i></p> <p><i>Wall units</i> <i>- with hinged door: 325 to 250 mm</i></p> <p><i>Reduction for product range C:</i> <i>Base units / highboards / tall units</i> <i>- with hinged door: 559 to 310 mm</i> <i>- with drawer / pull-out:</i> <i>559 to 440 mm = drawer / pull-out depth 400 mm</i> <i>439 to 310 mm = drawer / pull-out depth 270 mm</i></p> <p><i>Wall units</i> <i>- with hinged door: 325 to 250 mm</i></p>	ZUSTIEF	33

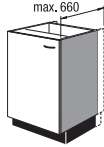
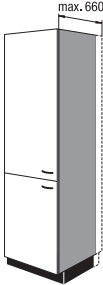

Surcharges/miscellaneous

		width	universal
 <p>Extra charge for carcass side increased depth per unit Increased depth of carcass side possible (both sides), variable between 561 and 660 mm.</p> <p><i>Available for the following cabinet types: Base units from a height of 723 mm, highboards and tall units, top units The capacity of the cabinet interior does not change if the width is reduced.</i></p> 	ZUSKT		37
<p>Surcharge for flat-pack or unglued pre-assembled cabinets surcharge per unit</p> <p><i>Unglued pre-assembled cabinets come with information on the actual item.</i></p>	ZUSZERL		10
<p>Extra charge for visible side for base units per visible side</p> <p>Please indicate visible side</p> <p><i>Colour version see summary of carcass colours</i></p>	SSU		36
<p>Extra charge for visible side for wall units per visible side</p> <p>Please indicate visible side</p> <p><i>Colour version see summary of carcass colours</i></p>	SSH		21
<p>Extra charge for visible side for highboards per visible side</p> <p>Please indicate visible side</p> <p><i>Colour version see summary of carcass colours</i></p>	SSHB		59
<p>Extra charge for visible side for tall units per visible side</p> <p>Please indicate visible side</p> <p><i>Colour version see summary of carcass colours</i></p>	SSS		73

Surcharges/miscellaneous

		width	universal
<p>Quick delivery service PRIME</p> <p>Surcharge per commission (multiple quantities excluded).</p> <p><i>Lead time for order receipt before 11:00 hrs: 6 Impuls working days</i></p> <p><i>Please note the delivery time indicated in the delivery note.</i></p> <p><i>This delivery service is available within Germany (excluding German islands).</i></p> <p><i>Colour Concept elements and glass recess back panels are not possible.</i></p> <p><i>Calculation group: net item</i></p>	ZUSPRIME		70
<p>Quick delivery service QUICK</p> <p>Surcharge per commission (multiple quantities excluded).</p> <p><i>Delivery on average in 14 Impuls working days</i></p> <p><i>Lead time for order receipt by:</i> <i>Tuesday at 7:00 hrs = 9 to 13 days</i> <i>Tuesday after 7:00 hrs = 14 to 18 days</i></p> <p><i>Please note the delivery time indicated in the delivery note.</i></p> <p><i>Colour Concept elements and glass recess back panels are not possible.</i></p> <p>ZUSQUICK <i>This delivery service is available for the following countries: Germany, Austria, Switzerland, Benelux countries (excluding their sovereign islands)</i></p> <p>ZUSQUICKF <i>Delivery service for France (excluding islands)</i></p> <p><i>Calculation group: net item</i></p>	ZUSQUICK ZUSQUICKF		9 12
<p>Customer deliveries</p> <p>Surcharge per commission (multiple quantities excluded).</p> <p><i>This delivery service is available within Germany.</i></p> <p><i>Calculation group: net item</i></p>	ZUSENDKDB		65



Surcharges/miscellaneous

		width	universal
 <p>III. shows version 629</p>	<p>Handle for single or follow-up orders except for handles with surcharge</p>	405500	4
	<p>Handle for single or follow-up orders for D-handle with surcharge</p>	405501	8
 <p>III. shows version 700</p>	<p>Bar handle for single or follow-up orders Please state version no.</p>	<p>Used for: Drawer / deep drawer width: 294 mm / Door height: 285 mm</p>	7
	<p>Used for: Drawer / deep drawer width: 394 mm / Door height: 357 mm</p>	405 802	8
	<p>Used for: Drawer / deep drawer width: 444 mm / Door height: 429 mm</p>	405 803	9
	<p>Use with: DR / PU width: 494 mm</p>	405 804	9
	<p>Used for: Door height: 573 mm</p>	405 805	10
	<p>Used for: Drawer / deep drawer width: 594 mm</p>	405 806	10
	<p>Used for: Door height: 717 / 749 mm</p>	405 807	12
	<p>Use with: Door height: 861 mm</p>	405 808	15
	<p>Use with: DR / PU width: 994 mm</p>	405 872	17
	<p>Used for: Drawer / deep drawer width: 894 mm / Door height: 893 mm</p>	405 839	15
	<p>Used for: Door height: 949 mm</p>	405 840	16
	<p>Used for: Door height: 1037 mm</p>	405 841	18
	<p>Used for: Drawer / deep drawer width: 1194 mm / Door height: 1181 mm</p>	405 842	20
	<p>Used for: Door height: 1325 mm</p>	405 843	21
<p>Used for: Drawer / deep drawer width: 794 mm</p>	405 844	13	
<p>Used for: Door height: 1469 mm</p>	405 874	22	



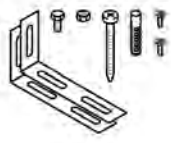

Surcharges/miscellaneous

			width	universal
Strip handle for single or follow-up orders Please state version no. Article serves the purpose of showing price!	Used for: Drawer / deep drawer width: 294 mm / Door height: 285 mm	.		11
	Used for: Drawer / deep drawer width: 394 mm / Door height: 357 mm	.		11
	Used for: Drawer / deep drawer width: 444 mm / Door height: 429 mm	.		12
	Use with: DR / PU width: 494 mm	.		12
	Used for: Door height: 573 mm	.		13
	Used for: Drawer / deep drawer width: 594 mm	.		13
	Used for: Door height: 717 / 749 mm	.		16
	Use with: Door height: 861 mm	.		17
	Used for: Drawer / deep drawer width: 894 mm / Door height: 893 mm	.		18
	Used for: Drawer / deep drawer width: 894 mm / Door height: 893 mm	.		20
Assembly instructions	Standard range	M01		0
	Product range C	CM01		0
Supplement for pre-fitted sinks or hobs per worktop cut-out <i>Only possible up to a worktop length of up to 2400 mm.</i>		ZUSAPL		12
Shelf for base units, highboards and tall units Depth 465 mm	300 mm unit width	IZ9730		5
	400 mm unit width	IZ9740		6
	450 mm unit width	IZ9745		6
	500 mm unit width	IZ9750		6
	600 mm unit width	IZ9760		6
	800 mm unit width	IZ9780		8
	900 mm unit width	IZ9790		8
	1000 mm unit width	IZ9710		9
	1200 mm unit width	IZ9712		11
Shelf for wall units Depth 250 mm	300 mm unit width	IZ9830		4
	400 mm unit width	IZ9840		5
	450 mm unit width	IZ9845		5
	500 mm unit width	IZ9850		5
	600 mm unit width	IZ9860		5
	800 mm unit width	IZ9880		6
	900 mm unit width	IZ9890		6
	1000 mm unit width	IZ9810		6

Surcharges/miscellaneous

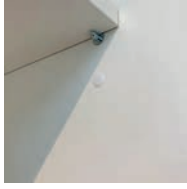
			width	universal
Glass shelf for wall units Depth 277 mm	450 mm unit width	IZ9945		5
	500 mm unit width	IZ9950		5
	600 mm unit width	IZ9960		5
Glass shelf for wall units Depth 250 mm	800 mm unit width	IZ9980		6
	900 mm unit width	IZ9990		7
	1000 mm unit width	IZ9910		7
Shelf for corner wall unit		IZ9460 IZ9465		8 9
Shelf for wall shelf unit Depth 295 mm	300 mm unit width	IZ9630		2
	450 mm unit width	IZ9645		3
	500 mm unit width	IZ9650		3
	600 mm unit width	IZ9660		3
 Wire shelf for broom cupboards 1 wire shelf to be fitted on site		404577		10
 Universal holder for broom cupboards 1 universal holder for cable, hose and vacuum cleaner accessories to be fitted on site		404 579		4
 Hook rail for broom cupboards 1 hook for brooms to be fitted on site		404 593		3
Carcase rail for max. 50 kg Set L+R		404838		20
Assembly/installation accessories for front connection 2 items in set consisting of: 2 brackets 8 screws		MZ FRO		3
 Anti-tilt device for island solution <i>Cannot be used in conjunction with underfloor heating.</i>		MZ INSEL		6

Surcharges/miscellaneous

			width		universal	
	Cover caps for 5 mm holes 10 each in bag			MZABDK	5	1
	Installation set for sinks / hobs with 25 mm worktops 3 undermounting strips in set, 16 x 12 mm Length: 840 mm			MZAPL25		13
	Front edge material <i>Calculated per mm</i> <i>Available for the following ranges:</i> <i>IP 1200, IP 2200, IP 3150, IP 4050</i>			FOK1000		2
	Edge protection for front material panel Stainless steel-coloured <i>Suitable for FBG 60</i>	595 mm wide		404826		6
	Set of plinth feet for on-site installation consisting of Plinth slides for fixing in place with Spax screws Plinth feet	Set of 4 ^{NEW} set of 5 ^{NEW}		SOFU SET 4 SOFU SET 5		3 4
	Plinth foot without slides 1 each Adjustment range -10 mm / + 25 mm	105 mm plinth height 155 mm plinth height 205 mm plinth height		SOFU SOFU SOFU	105 155 205	2 2 3
	Plinth foot slide with dowel 1 each			SOFU GL		1
	Plinth foot glider set for on-site installation comprising 4 plinth slides to be secured with Spax screws <i>Feet must be ordered separately.</i>			SOFU SET		3

10. Accessories





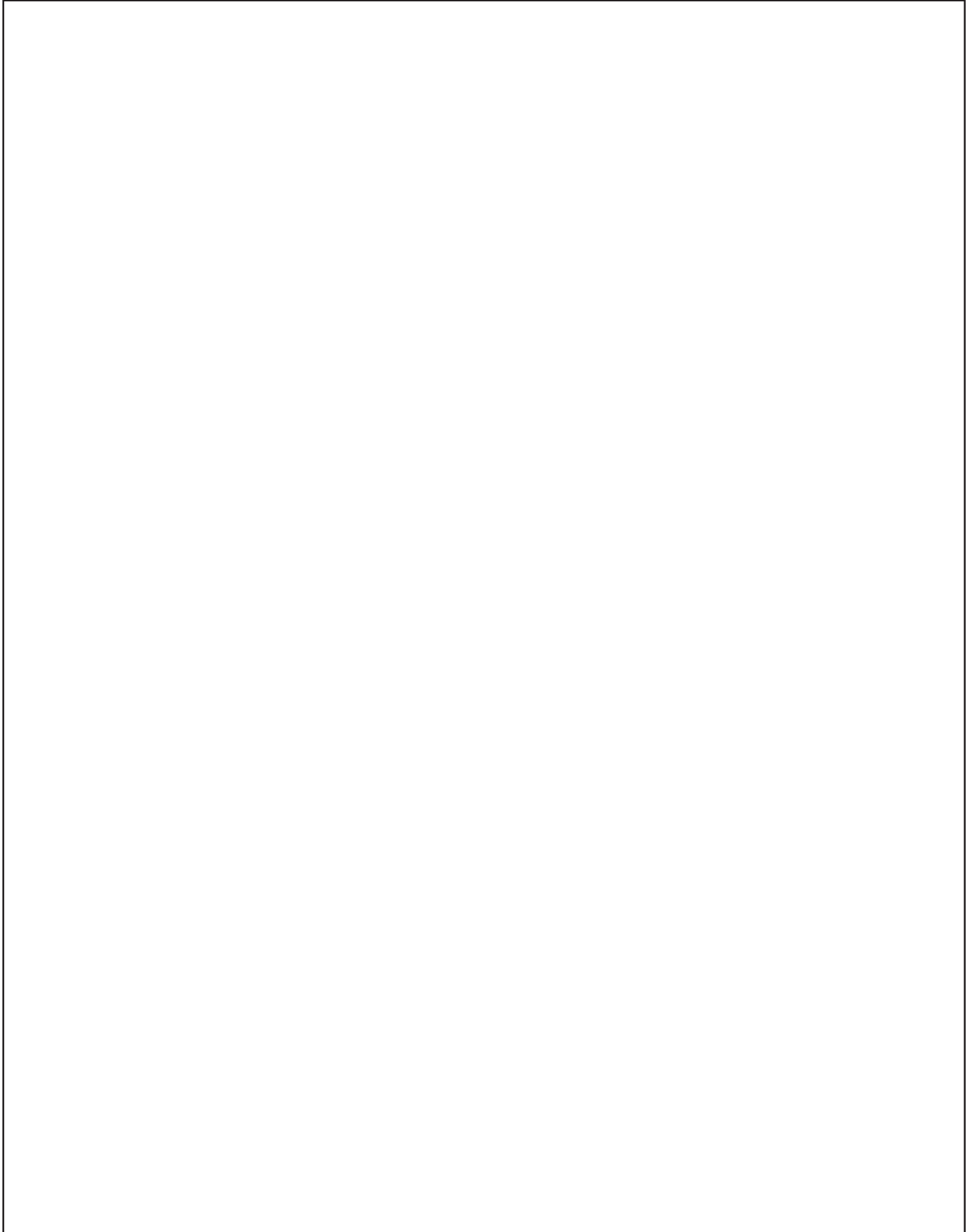

Interior equipment
Lighting / sockets
Sinks / mixer taps
Miscellaneous accessories
Storage space / utility room





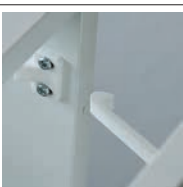

Interior equipment

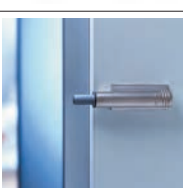

Interior equipment

		width	Item	universal
	<p>Baking sheet holder high-gloss chrome effect Set consisting of 2 mounts</p>		ZIBH 60	14
	<p>Shelf rail silver-grey 36 mm high for 60 cm unit width for securing shelves</p>	504	ZI 504 SG	1
	<p>Set of spice jars Suitable spice jar holders</p> <p><i>Spices:</i> <i>Tomato seasoning salt, nutmeg, basil, garlic, curry, dill tips, steak seasoning, cumin, cinnamon, pepper, sweet pepper, chicken seasoning salt</i></p>	12 jars	ZI 12	6
	<p>Spice jar holder silver-grey for 12 jars up to Ø 57 mm 500 mm high, 60 mm deep to be fitted to wall unit door</p>	from 300 mm unit width	210 ZI 301 SG	5
	<p>Child safety 2-piece in white plastic Can be retrofitted.</p>		ZI 4	1
	<p>Cushioning for larder units for closing larder unit pull-outs gently and quietly to be fitted on site</p> <p><i>Damper for pull-out fitting at top</i></p>		ZID 30	10
	<p>Cushioning for larder units as above</p> <p><i>Damper for pull-out fitting at bottom</i></p>		404 340	8
	<p>Soft close for hinged doors for a soft and quiet closing function of hinged doors Additional fittings are possible on carcass sides, shelves and infill panels, 1 x per door. Consisting of: Soft closing part, fixing plate and adapter part.</p> <p><i>With connected, tall or heavy doors, a second mechanism has to be used.</i></p>	per piece in packs of 5	ZI 23 ZI 23 5	2 4

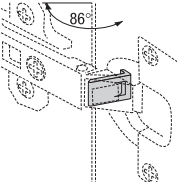
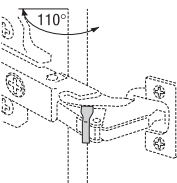
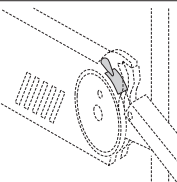
Interior equipment

		width	Item	universal
	<p>Soft close for hinged doors</p> <p>for a soft and quiet closing function of hinged doors for retrofitting onto door hinges 1 required per door A second buffer is required on hinged doors with 3 hinges.</p> <p><i>Not suitable for:</i> Base or tall units with interior deep drawers Diagonal units Wall units with hinged doors and 170° opening angle</p>	per piece in packs of 5	ZID 24 ZID 24 5	2 4
	<p>Mechanical opening assistance for hinged doors</p> <p>Hinged doors open by simply tapping. Can be retrofitted to carcass sides, shelves, cross bars or posts.</p>	per piece	ZID 251	4
	<p>Limiter for hinges</p> <p>Limits opening angle to 86° for 107° fast-assembly hinges</p> <p>in packs of 10</p>		ZI 9	2
	<p>Limiter for hinges</p> <p>Limits opening angle to 110° for 155° hinges grey</p> <p>in packs of 10</p>		ZI 15	3
	<p>Limiter for energy accumulator for upward folding door units</p> <p>Limits opening angle to 104° The minimum distance to the ceiling is reduced: on 723 mm high units from 200 mm to 140 mm and on 573 mm high units from 150 mm to 110 mm</p> <p>1 each</p>		ZI 16	2
	<p>Limiter for energy accumulator for upward folding door units</p> <p>Opening angle limited to 83° There is no need for a minimum distance to the ceiling.</p> <p>1 each</p>		ZI 17	2
	<p>Cushioned self closing action</p> <p>for LeMans units Can be retrofitted.</p> <p><i>Used only on Le Mans shelves from April 2012.</i></p>	2 items in set	ZID 29	11

Lighting / sockets

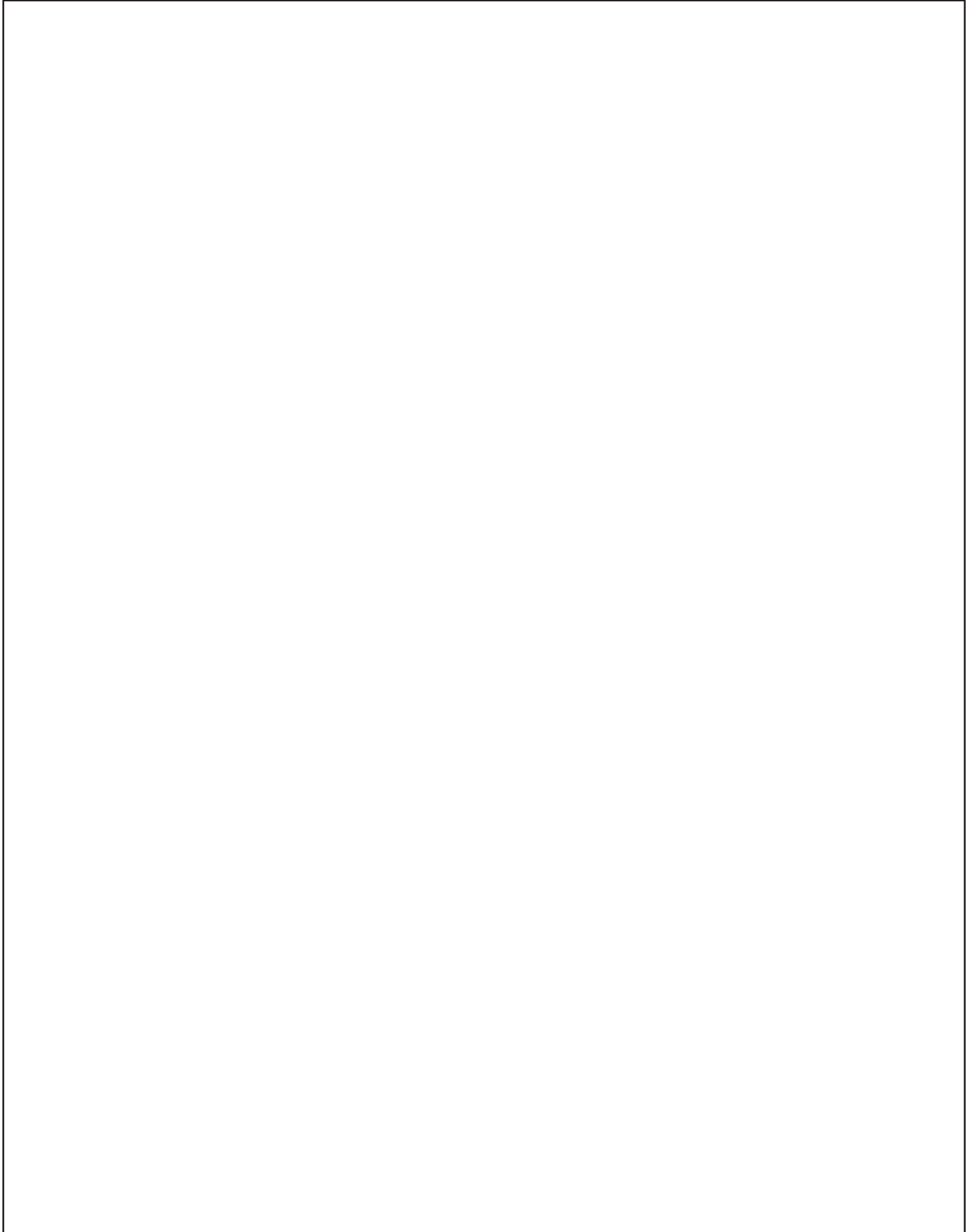

Lighting / sockets

Planning advice

General information

All lights, converters, switches and controllers have a uniform plug system
 The extension cable offered may only be used 1 x per light.
 Use a uniform 2-core cable and plug system (for all LED lights with or without light colour temperature change)



Light colour temperature, general

Control of the light colour temperature with suitable LED lights from 2700 K (warm light) up to 6500 K (cold light) possible.

The light colour temperature has an affect on the perception of colours. See example left.

The light colour temperature also has an affect on the human body. Warm light has a calming effect, cold light has a stimulating effect.

We recommend the use of light colour temperature control in order to be able to govern the light in response to various colour perceptions.

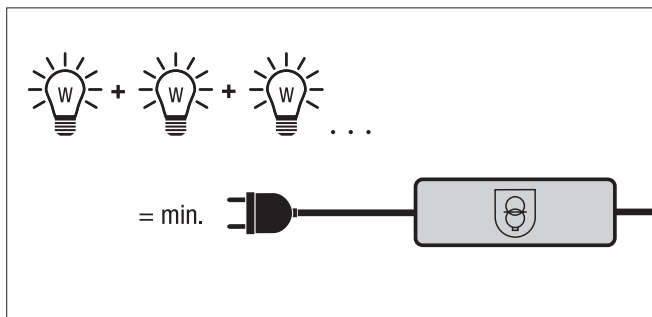

Selecting the correct converter

Addition of the watt value of all lights = minimum converter power

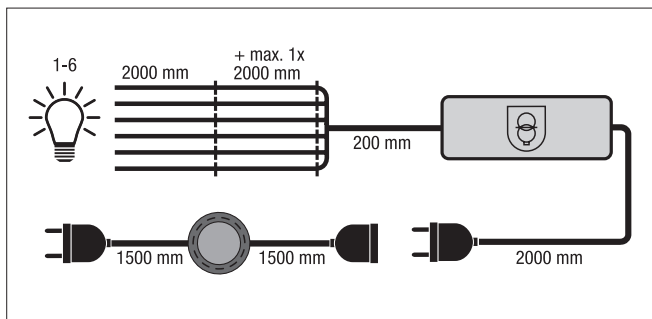

Standard plan with on/off switch

Example shown:
 1500 mm cable 220-240 V, switch 220-240 V, 1500 mm cable 220-240 V
 2000 mm cable 220-240 V, 1 converter, 200 mm cable
 6-way distributor
 max. 1 x extension by 2000 mm per light
 1-6 lights each with 2000 mm cable

Order extension cables separately!

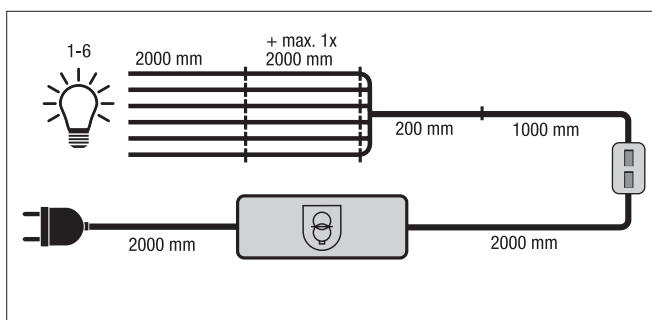

Standard plan with starter set Touch LED Emotion

Example shown:
 2 metre cable 220-240 V, 1 converter,
 2 metre cable, Touch LED Emotion switch, 1 metre cable
 200 mm cable, 6-way distributor
 max. 1 x extension by 2 metres per light
 1-6 lights each with 2 metre cable

Order extension cables separately!

Planning advice

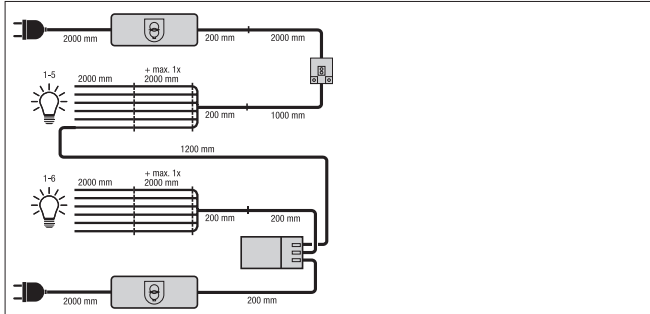

Standard plan Touch LED Emotion starter set incl. expansion set
 Converter with 2 metre connection cable and 200 mm output cable, Touch LED Emotion switch incl. 2 metre input cable and 1 metre output cable, 6-way distributor with 200 mm cable, 1-5 lights, connection of LED repeater to 6-way distributor to the starter set with 1.2 metre connection cable and connection to the converter expansion set incl. 2 metre connection cable and 200 mm cable und 6-way distributor with 200 mm cable, 1-6 lights

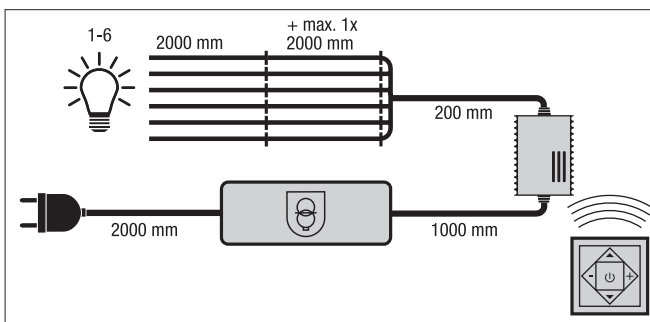

Standard plan with starter set 1-channel remote control
 Example shown:
 2 metre cable 220-240 V, 1 converter, 1 metre cable wireless receiver, 200 mm cable 6-way distributor
 max. 1 x extension by 2 metres per light
 1-6 lights each with 2 metre cable
 1 remote control

Order extension cables separately!

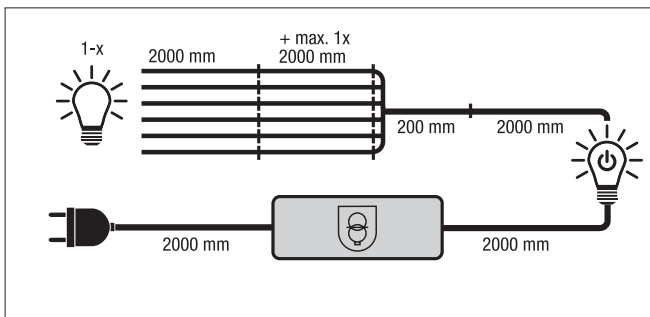



Cabling set with switch integrated into the light
 Example shown:
 2 metre cable 220-240 V, 1 converter, 2 metre cable, switch integrated into the light, 2 metre cable 200 mm cable, 3 to 6-way distributor
 max. 1 x extension by 2 metres per light
 1-X lights each with 2 metre cable

Order extension cables separately!

LED lighting options for wall units

Order electronic LED transformers, start sets and connection accessories separately.

		width	Item	universal	
<p>Planning advice</p> <p>Choosing the surcharge for the lighting option on the wall unit means the bottom shelf and/or the top shelf will have the required cut-out. The up/down lighting is fitted at the works, LED linear and LED built-in lights are added to the accessories box and have to be fitted on-site. This makes the order process easier as there is no need to order the lights in addition to the cut-out.</p> <p>The shelf features are chosen in the order header: 963 = features of bottom shelf 964 = features of top shelf</p> <p>Please observe the following planning information: - Available for cabinet widths 300 - 1000 mm - Width and depth reductions are not possible - 60 cm and 65 cm corner wall units, diagonal wall units, shelf units in variable dimensions, end shelf units are not possible</p> <p>Order electronic LED transformers, start sets and connection accessories separately.</p>					
	<p>Grip ledge with up/down LED lighting</p> <p>Version 200, surcharge per unit</p>		MP963	23	
	5.8 W, 490 lm	300			
	Surcharge includes:	8.2 W, 673 lm			400
	Grip ledge with up/down LED lighting in bottom shelf of carcass instead of handle profile without lighting	9.3 W, 764 lm			450
	Light colour temperature:	10.5 W, 856 lm			500
	with control unit: 2700 - 6500 K, without control unit: 2700 K	12.8 W, 1039 lm			600
	including 1.8 metre extension cable as an accessory with mini-plug	17.5 W, 1405 lm			800
	Light source energy efficiency class	19.8 W, 1588 lm			900
	Top: F	22.1 W, 1771 lm			1000
	Bottom: G				
<p><i>Only possible for wall units with integrated handle profile on carcass base panel (article types CH...).</i></p> <p><i>Do not include light pelmets in plans.</i></p>					
	<p>LED built-in light, straight aluminium profile</p> <p>Extra charge per cabinet</p>		MP963	18	
	3 W, 288 lm	300			
	Version 210 = stainless steel effect	4.2 W, 396 lm			400
	Surcharge includes:	4.8 W, 450 lm			450
	cut-out in bottom shelf of cupboard	5.4 W, 504 lm			500
	LED built-in light ZLIL...ECC	6.6 W, 612 lm			600
	Light colour temperature:	9 W, 828 lm			800
	with control unit: 2700 - 6500 K, without control unit: 2700 K	10.2 W, 936 lm			900
with connecting cable, 2 metres, including mini-plug	11.4 W, 1044 lm	1000			
Light source energy efficiency class: G					

LED lighting options for wall units

Order electronic LED transformers, start sets and connection accessories separately.

		width	Item	universal
	<p>LED built-in spotlight Extra charge per cabinet Version 221 = stainless steel effect</p> <p>Surcharge includes: cut-out in bottom shelf of cupboard LED built-in spotlight, ZLI 58 ... Each light: 4.0 W, 250 lm Light colour temperature: 3000 K with connecting cable, 2 metres, including mini-plug Light source energy efficiency class: F</p>		MP963	8
	<p>LED built-in spotlight with colour control Extra charge per cabinet Version 220 = stainless steel effect Version 222 = black</p> <p>Surcharge includes: cut-out in bottom shelf of cupboard with connecting cable, 2 metres, including mini-plug</p> <p>Energy efficiency of light source: refer to individual item</p> <p>Version 220 = stainless steel effect: LED built-in spotlight, ZLI 58 ECC Each light: 3.0 W, 160 lm Light colour temperature: with control unit: 3000 - 6000 K without control unit: 3000 K</p> <p>Version 222 = black: LED built-in spotlight: ZLI 58 SCC Each light: 4.0 W, 250 lm Light colour temperature: with control unit: 2700 - 6500 K without control unit: 2700 K</p>	1 light for units to 600 mm wide	MP963	15
	<p>Version 220 = stainless steel effect 1 light for units to 600 mm wide</p>		MP963	11
	<p>Version 220 = stainless steel effect 2 lights for units from 800 mm wide</p>		MP963	21
	<p>Version 222 = black 1 light for units to 600 mm wide</p>		MP963	11
	<p>Version 222 = black 2 lights for units from 800 mm wide</p>		MP963	21

LED lighting options for wall units

Order electronic LED transformers, start sets and connection accessories separately.

	width	Item	universal
 <p>LED built-in spotlight Extra charge per cabinet Version 221 = stainless steel effect Surcharge includes: Cut-out in top shelf of cupboard LED built-in spotlight, ZLI 58 ... Each light: 4.0 W, 250 lm Light colour temperature: 3000 K with connecting cable, 2 metres, including mini-plug Light source energy efficiency class: F</p>	1 light for units to 600 mm wide	MP964	8
	2 lights for units from 800 mm wide	MP964	15
<p>LED built-in spotlight with colour control Extra charge per cabinet Version 220 = stainless steel effect Version 222 = black Surcharge includes: Cut-out in top shelf of cupboard with connecting cable, 2 metres, including mini-plug Energy efficiency of light source: refer to individual item</p>	Version 220 = stainless steel effect 1 light for units to 600 mm wide	MP964	11
<p>Version 220 = stainless steel effect: LED built-in spotlight, ZLI 58 ECC Each light: 3.0 W, 160 lm Light colour temperature: with control unit: 3000 - 6000 K without control unit: 3000 K</p>	Version 220 = stainless steel effect 2 lights for units from 800 mm wide	MP964	21
<p>Version 222 = black: LED built-in spotlight: ZLI 58 SCC Each light: 4.0 W, 250 lm Light colour temperature: with control unit: 2700 - 6500 K without control unit: 2700 K</p>	Version 222 = black 1 light for units to 600 mm wide	MP964	11
	Version 222 = black 2 lights for units from 800 mm wide	MP964	21

Linear lights, Built-in light fixtures

		width	Item	universal	
 <p>LED built-in light for light cutouts Straight aluminium profile</p> <p>Colour temperature infinitely variable from warm white to cold white. Cover semi-transparent Light colour temperature: without control unit: 2700 K with control unit: 2700 - 6500 K Dimmer function: yes Beam angle: 70 degrees 12 Volt Cable length 2 metres incl. mini-plug Light source energy efficiency class: G</p> <p><i>Order light slot separately</i></p> <p><i>Order electronic LED transformers and connection accessories separately.</i></p>	3 W, 288 lm	267	ZLIL 300 ECC	9	
	4.2 W, 396 lm	367	ZLIL 400 ECC	10	
	4.8 W, 450 lm	417	ZLIL 450 ECC	11	
	5.4 W, 504 lm	467	ZLIL 500 ECC	11	
	6.6 W, 612 lm	567	ZLIL 600 ECC	12	
	9 W, 828 lm	767	ZLIL 800 ECC	15	
	10.2 W, 936 lm	867	ZLIL 900 ECC	16	
	11.4 W, 1044 lm	967	ZLIL 1000 ECC	17	
	<hr/>				
	 <p>LED built-under light set Aluminium profile, angled</p> <p>for installation below the gap between wall unit bottom and installation wall, under the carcass exterior Colour temperature infinitely variable from warm white to cold white. Cover semi-transparent Light colour temperature: without control unit: 2700 K with control unit: 2700 - 6500 K Dimmer function: yes Beam angle: 80 degrees 12 Volt incl. mounting hardware Cable length 2 metres incl. mini-plug Light source energy efficiency class: G</p> <p><i>Can also be planned for niche back panels in full height!</i></p> <p><i>Order electronic LED transformers and connection accessories separately.</i></p> <p><i>Not possible in combination with light pelmets.</i></p>	3.3 W, 324 lm	300	ZLNL 300 ECC	9
4.5 W, 432 lm		400	ZLNL 400 ECC	10	
5.1 W, 468 lm		450	ZLNL 450 ECC	10	
5.7 W, 540 lm		500	ZLNL 500 ECC	11	
6.9 W, 648 lm		600	ZLNL 600 ECC	12	
9.3 W, 864 lm		800	ZLNL 800 ECC	15	
10.5 W, 972 lm		900	ZLNL 900 ECC	16	
11.7 W, 1080 lm		1000	ZLNL 1000 ECC	17	
<hr/>					
 <p>LED built-in spotlight stainless steel-effect</p> <p>4.0 W, 250 lm</p> <p>Cover semi-transparent Light colour temperature: 3000 K Dimmer function: yes Beam angle: 110 degrees 12 Volt Cable length 2 metres incl. mini-plug External diameter: 65 mm, drill hole: 57 mm Light source energy efficiency class: F</p> <p><i>Order light slot separately</i></p> <p><i>Order electronic LED transformers and connection accessories separately.</i></p>		4.0 W, 250 lm	65	ZLI 58 E	5



Built-in light fixtures

		Item		width	universal
 <p>LED built-in spotlight black</p> <p>Cover semi-transparent Light colour temperature: without control unit: 2700 K with control unit: 2700 - 6500 K Dimmer function: yes Beam angle: 110 degrees 12 Volt Cable length 2 metres incl. mini-plug External diameter: 65 mm, drill hole: 57 mm Light source energy efficiency class: F</p> <p><i>Order light slot separately</i></p> <p><i>Order electronic LED transformers and connection accessories separately.</i></p>	4.0 W, 250 lm	65	ZLI 58 SCC		8
 <p>LED built-in / built under spotlight stainless steel-effect</p> <p>Cover semi-transparent Light colour temperature: with control unit: 3000 - 6000 K without control unit: 3000 K Dimmer function: yes Beam angle: 110 degrees 12 Volt Cable length 2 metres incl. mini-plug incl. installation ring External diameter: 63 mm, drill hole: 57 mm Light source energy efficiency class: G</p> <p><i>Order light slot separately</i></p> <p><i>Order electronic LED transformers and connection accessories separately.</i></p>	3.0 W, 160 lm	64	ZLI 58 ECC		8



Built-under lights

		width	Item	universal
	Set of 3 LED triangular lights stainless steel-effect Cover transparent Light colour temperature: 4000 K Dimmer function: no Beam angle: 120 degrees 12 Volt Cable length 2 metres incl. mini-plug of which 1 light with master switch and 2 x 2 metre cables incl. mini-plug 1 electronic transformer, 15 W with 2 metre connecting cable with Euro plug Distributor for mini-plug with 200 mm cable Light source energy efficiency class: D <i>Can not be extended.</i>	3 x 1.75 W, 3 x 100 lm	130 ZLU 136 IXS3	13
	Set of 5 LED triangular lights stainless steel-effect as above	5 x 1.75 W, 5 x 100 lm	130 ZLU 136 IXS5	19
	LED built-under light set Brushed aluminium Cover semi-transparent Light colour temperature: 2700 - 6500 K Dimmer function: yes Beam angle: 77 degrees 12 Volt Cable length 1.8 metres incl. mini-plug 185 x 50 x 6,6 mm Light source energy efficiency class: F <i>Order electronic LED transformers and connection accessories separately.</i>	4.0 W, 216 - 235 l	50 ZLU 185 ACC	11
	Set of 3 LED built-under light set Brushed aluminium Cover semi-transparent Light colour temperature: 2700 - 6500 K Dimmer function: yes Beam angle: 77 degrees 12 Volt Cable length 1.8 metres incl. mini-plug 185 x 50 x 6,6 mm 1 integrated switch 1 electronic transformer, 20 W with 2 metre connecting cable with Euro plug Distributor for mini-plug with 200 mm cable Light source energy efficiency class: F <i>Can be extended up to a maximum of 5 lights.</i>	3 x 4.0 W, 3 x 216 - 235 l	50 ZLU 185 ACCS3	34
	LED built-under light set black Cover semi-transparent Light colour temperature: 2700 - 6500 K Dimmer function: yes Beam angle: 77 degrees 12 Volt Cable length 1.8 metres incl. mini-plug 185 x 50 x 6,6 mm Light source energy efficiency class: F <i>Order electronic LED transformers and connection accessories separately.</i>	4.0 W, 216 - 235 l	50 ZLU 185 SCC	11

Built-under lights, Ambient lighting

		Item		width	universal
	<p>Set of 3 LED built-under light set black 3 x 4.0 W, 3 x 216 - 235 l</p> <p>Cover semi-transparent Light colour temperature: 2700 - 6500 K Dimmer function: yes Beam angle: 77 degrees 12 Volt Cable length 1.8 metres incl. mini-plug 185 x 50 x 6,6 mm</p> <p>1 integrated switch 1 electronic transformer, 20 W with 2 metre connecting cable with Euro plug Distributor for mini-plug with 200 mm cable Light source energy efficiency class: F</p> <p><i>Can be extended up to a maximum of 5 lights.</i></p>	50	ZLU 185 SCCS3	34	
	<p>LED recessed grip lighting 7.8 W per metre started Profile</p> <p>Lighting of the handle recess (L profile) below the worktop for base units Colour temperature infinitely variable from warm white to cold white.</p> <p>Cover semi-transparent Light colour temperature: without control unit: 2700 K with control unit: 2700 - 6500 K Dimmer function: yes Beam angle: 120 degrees 12 Volt incl. necessary end caps, inside/outside corners, fixings and connection cable Cable length 2.8 m incl. mini-plug Light source energy efficiency class: F</p> <p><i>Order electronic LED transformers and connection accessories separately.</i></p> <p><i>Not possible for units with handle profile milling.</i></p> <p><i>Maximum length: 4000 mm</i></p> <p><i>Information on pricing: Depending on the planning software, the required length of the LED recessed grip ledge lighting must be specified in the commercial data for the correct price indication.</i></p> <p><i>Calculated per mm</i></p>	150 -4000	CHLED U	36	
	Inner corner 90° per piece		CHLED IE	1	
	Outer corner 90° per piece		CHLED AE	1	
	End cap left per piece		CHLED EL	1	
	End cap right per piece		CHLED ER	1	
	<p>Plinth lighting set 7.20 watts per metre</p> <p>Light colour temperature: without control unit: 3000 K with control unit: 3000 - 6000 K Dimmer function: yes 12 Volt Cable length 2 metres incl. mini-plug 2 x 1100 mm profile LED light strip 2200 mm Light source energy efficiency class: G</p> <p><i>Order electronic LED transformers and connection accessories separately.</i></p>	2200	ZLSO 2200 CC	15	
	<p>Plinth lighting set 7.20 watts per metre</p> <p>same as above, but 3 x 1100 mm profile LED light strip 3300 mm</p> <p><i>Order electronic LED transformers and connection accessories separately.</i></p>	3300	ZLSO 3300 CC	22	

Connection accessories for control with Touch LED Emotion switch.

	width	Item	universal
 <p>Touch LED Emotion starter set 30 watts Converter 30 watts 12 Volt Touch LED Emotion switch Functions: ON/OFF, dimming, light colour temperature control including 6-way distributor 2000 mm connecting cable socket with Europlug 255 x 30 x 16 mm <i>Note expansion set!</i></p> <p>Touch LED Emotion expansion set Expansion by 30 watts Converter 30 watts 12 Volt 2000 mm connecting cable 1 LED repeater <i>The extension set is to be used if the number of watts of the start set is exceeded.</i></p>		ZLZTS 30 CC	19
 <p>Touch LED Emotion starter set 60 watts Converter 60 watts 12 Volt including Emotion controller Touch LED Emotion switch Functions: ON/OFF, dimming, light colour temperature control including 12-way distributor 2000 mm connecting cable socket with Europlug 290 x 44 x 16 mm <i>Note expansion set!</i></p> <p>Touch LED Emotion expansion set Expansion by 30 watts Converter 30 watts 12 Volt 2000 mm connecting cable 1 LED repeater <i>The extension set is to be used if the number of watts of the start set is exceeded.</i></p>		ZLZTS 60 CC	33
		ZLZTSF 30 CC	24



Connection accessories for remote control

	width	Item	universal
 <p>Bluetooth starter set 30 watts Ballast incl. Emotion-Driver Functions: ON/OFF, dimming, light colour temperature control integrated 6-way distributor 12 Volt Bluetooth receiver 2000 mm connecting cable socket with Europlug 1 1-channel remote control <i>L&S Bluetooth Emotion app available in the App Store</i></p>		ZLZFB 30 CC2	40
 <p>1-channel remote control starter set 60 watts Converter 60 watts 12 Volt 1 wireless receiver 1 1-channel remote control Functions: ON/OFF, dimming, light colour temperature control including 12-way distributor 2000 mm connecting cable socket with Europlug <i>Note expansion set!</i></p> <p>1-channel remote control expansion set Expansion by 30 watts Converter 30 watts 12 Volt 1 wireless receiver including 6-way distributor 2000 mm connecting cable 255 x 30 x 16 mm <i>The extension set is to be used if the number of watts of the start set is exceeded.</i></p> <p>1-channel remote control expansion set Expansion by 60 watts Converter 60 watts 12 Volt 1 wireless receiver including 12-way distributor 2000 mm connecting cable 290 x 44 x 16 mm <i>The extension set is to be used if the number of watts of the start set is exceeded.</i></p>		ZLZF 60 CC2	36
		ZLZFF 30 CC	24
		ZLZFF 60 CC	26
 <p>1-channel remote control 1 1-channel remote control Functions: ON/OFF, dimming, light colour temperature control for follow-up orders <i>suitable for ZLZFB 30 CC2, ZLZF 60 CC2, ZLZFF 30 CC, ZLZFF 60 CC</i></p>		ZLZ F2	10

Connection accessories for remote control

	width	Item	universal
 <p>4-channel remote control 1 4-channel remote control Functions: ON/OFF, dimming, light colour temperature control All functions can be set individually for up to 4 groups. Two lighting scenes can be stored</p> <p><i>suitable for ZLZFB 30 CC2, ZLZF 60 CC2, ZLZFF 30 CC, ZLZFF 60 CC</i></p>		ZLZ F4K	14



Other connection accessories

		width	Item	universal
	<p>Surface-mounted switch for connection on the high-voltage side up to max. 240 V Functions: ON/OFF Cable length input: 1.5 metres incl. Euro plug Cable length output: 1.5 metres for. Euro plug</p>	68	ZLZ 8	4
	<p>Extension cable for LED lights Cable length 1.8 metres incl. mini-plug <i>For use with all LED-light versions.</i></p>		ZLZ 2000	2
	<p>Electronic LED transformer for general-purpose use Input: 220-240 V, output: 12 V/DC, 1.25 A 2 metre connecting cable with Euro plug 6-way distributor for mini-plug with 200 mm cable 130 x 45 x 16 mm <i>Suitable for all LED single lights. Note planning advice.</i></p>	15 W	150 ZLZT 15	6
	<p>Electronic LED transformer for general-purpose use same as above, but 255 x 30 x 16 mm <i>Suitable for all LED single lights. Note planning advice.</i></p>	30 W	170 ZLZT 30	9
	<p>Electronic LED transformer for general-purpose use same as above, but 12-way distributor for mini-plug with 200 mm cable 290 x 44 x 16 mm <i>Suitable for all LED single lights. Note planning advice.</i></p>	60 W	263 ZLZT 60	13

Socket elements

		width	Item	universal
	<p>3-way socket element Stainless steel</p> <p>for corner installation with telescoping, overall height 460-580 mm for completely covering the niche Width 82 mm, depth 60 mm 3 earthed sockets 240 V / 16 A 2 metre connecting cable 1 earthed plug for fitting on-site</p>		ZLZSE 460 IX	14
	<p>3-way socket element Stainless steel</p> <p>for corner installation 3 earthed sockets 240 V / 16 A 1 USB socket, 1000 A / 5 V 2 metre connecting cable 1 earthed plug for fitting on-site 320 x 82 x 60 mm</p> <p><i>Horizontal and vertical installation possible.</i></p>		ZLZSE 320 IX	17
	<p>2-way socket element Stainless steel</p> <p>for corner installation 2 earthed sockets 240 V / 16 A 2 metre connecting cable 1 earthed plug for fitting on-site 200 x 115 x 82 mm</p> <p><i>Horizontal and vertical installation possible.</i></p>		ZLZSE 115 IX	10
	<p>Single socket</p> <p>fitted with choice of ring or cover 1 earthed socket 250 V / 16 A 2.5 m connecting cable with ferrules 1 earthed plug for fitting on-site Drill hole: 54 mm Installed depth: 50 mm Outer diameter 59 mm</p> <p><i>For installation material thickness from 9 mm</i></p>	stainless steel-effect	ZLZSI 59 IX	17
		black	ZLZSI 59 S	17



Socket elements

		Item		width	universal
	<p>DUPLEX Built-in socket element For installation in worktops with max. thickness 40 mm</p> <p>Square</p> <p>2 earthed sockets 240 V / 16 A Socket cover opens/ closes electronically 2.0 m connecting cable with pre-mounted earthing pin plug</p> <p><i>Drill hole: 105 mm</i> <i>Installed depth: 45.5 mm</i> <i>External dimensions: 118 x 118 mm</i></p> <p><i>DUPLEX is made to be used in almost all known kitchen worktops. Simply touch the button until the socket opens / closes. Very low mounting parts, so can be fitted under drawers.</i></p> <p>BENEFITS at a glance: very low installation depth compact design subsequent installation possible quick and easy installation genuine stainless steel opens / closes electronically</p>	<p>stainless steel-effect black</p>	ZLZSI 105 QIX	26	
			ZLZSI 105 QS		
	<p>DUPLEX Built-in socket element</p> <p>For installation in worktops with max. thickness 40 mm</p> <p>Round</p> <p>2 earthed sockets 240 V / 16 A Socket cover opens/ closes electronically 2.0 m connecting cable with pre-mounted earthing pin plug</p> <p><i>Drill hole: 105 mm</i> <i>Installed depth: 45.5 mm</i> <i>Outer diameter: 118 mm</i></p> <p><i>DUPLEX is made to be used in almost all known kitchen worktops. Simply touch the button until the socket opens / closes. Very low mounting parts, so can be fitted under drawers.</i></p> <p>BENEFITS at a glance: very low installation depth compact design subsequent installation possible quick and easy installation genuine stainless steel opens / closes electronically</p>	<p>stainless steel-effect black</p>	ZLZSI 105 RIX	26	
			ZLZSI 105 RS		

Socket elements

		width	Item	universal
	<p>PICCOLINO Built-in socket element retractable For installation in worktops with max. thickness 40 mm</p> <p>2 earthed sockets 240 V / 16 A, IP44 2.0 m connecting cable with pre-mounted earthing pin plug</p> <p><i>Hole cutout: 111.7 x 67.8 mm (drilling template)</i> <i>Installed depth: 47.5 mm</i> <i>External dimensions: 118 x 118 mm</i></p> <p><i>PICCOLINO pushes together when closed for an overall depth of less than 48 mm. This means PICCOLINO can easily be fitted over drawers.</i></p>	<p>stainless steel-effect black</p>	<p>ZLZSI 112 OIX ZLZSI 112 OS</p>	<p>21 21</p>
	<p><i>BENEFITS at a glance:</i> very low installation depth compact design subsequent installation possible quick and easy installation genuine stainless steel protected against splashes when closed</p>			
	<p>Built-in socket element For installation in worktops with max. thickness 40 mm</p> <p>Turning lid and frame in brushed stainless steel Turning lid with Soft-Touch 2 earthed sockets 1 USB charger (2100 mA) USB type C 2.5 m connecting cable with ferrules Including safety plug 230 V / 16 A</p> <p><i>Cutout 215 x 88 mm</i> <i>Installed depth 53 mm</i> <i>Item dimensions 226 x 105.3 x 56 mm</i></p>	<p>For Switzerland only For the UK only</p>	<p>ZLZSI 225 IX ZLZSI 225 IXCH ZLZSI 225 IXUK</p>	<p>35 44 44</p>
				
	<p>Built-in socket element For installation in worktops with max. thickness 40 mm</p> <p>same as above, but Turning lids and frames in matt black lacquer</p>		<p>ZLZSI 225 S</p>	<p>39</p>

Socket elements

		Item	
		width	universal
 <p>3-way socket with earthed plug white Extra narrow angle plug Illuminated switch for ON / OFF Socket alignment turned through 90 degrees with increased touch-protection 240 V / 16 A, max. 3500 W 1.4 metre connecting cable with earthed plug For screwing on, horizontal and vertical installation possible Cable rewind <i>Thanks to the low overall height of the plug (8 mm), units placed in front of sockets can be positioned almost flush against the wall.</i></p>		ZLZS 1	7
 <p>3-way worktop plug socket white 1.4 metre connecting cable with earthed plug with increased touch-protection 250 V / 16 A</p>		ZLZ S2	4

Notes

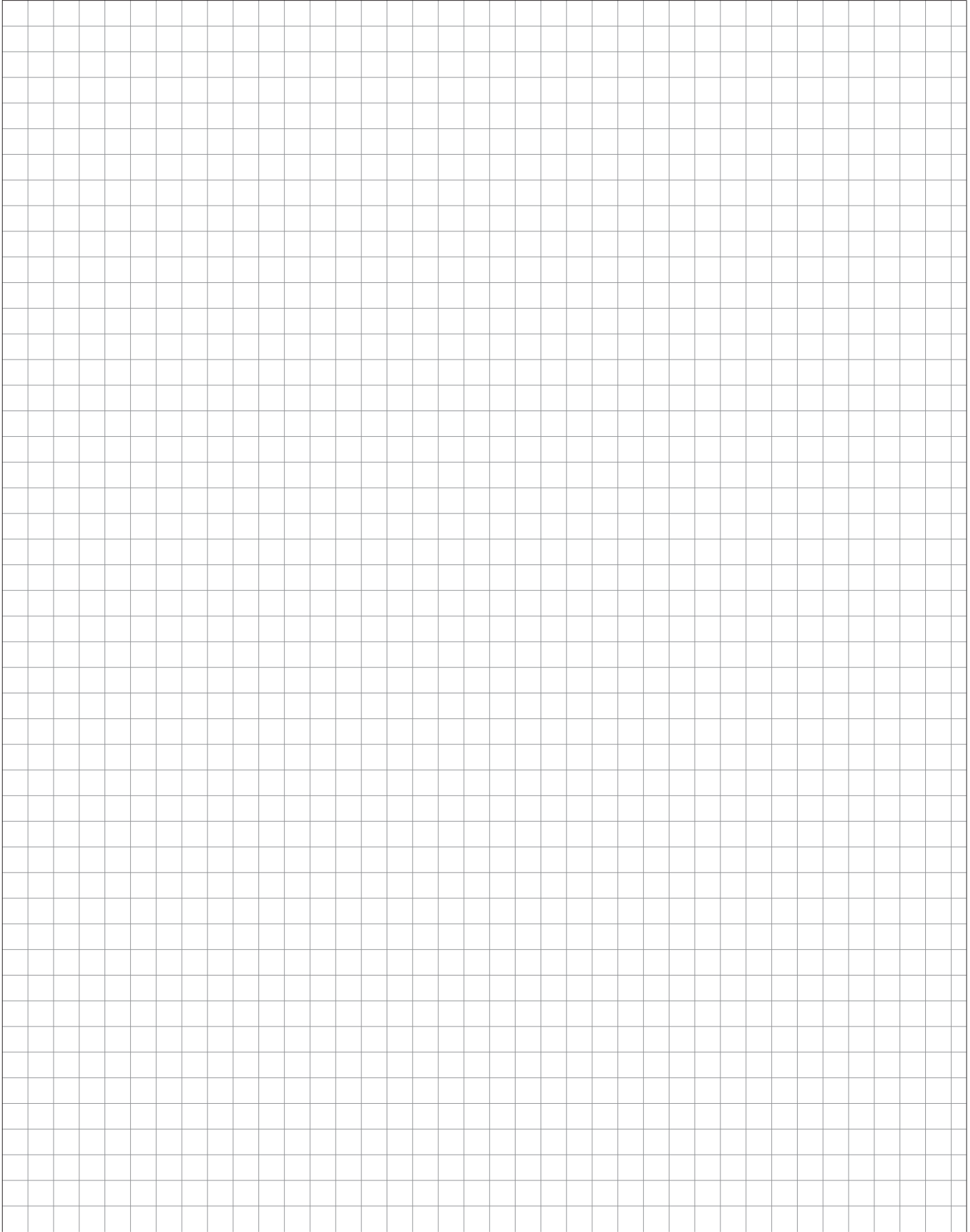



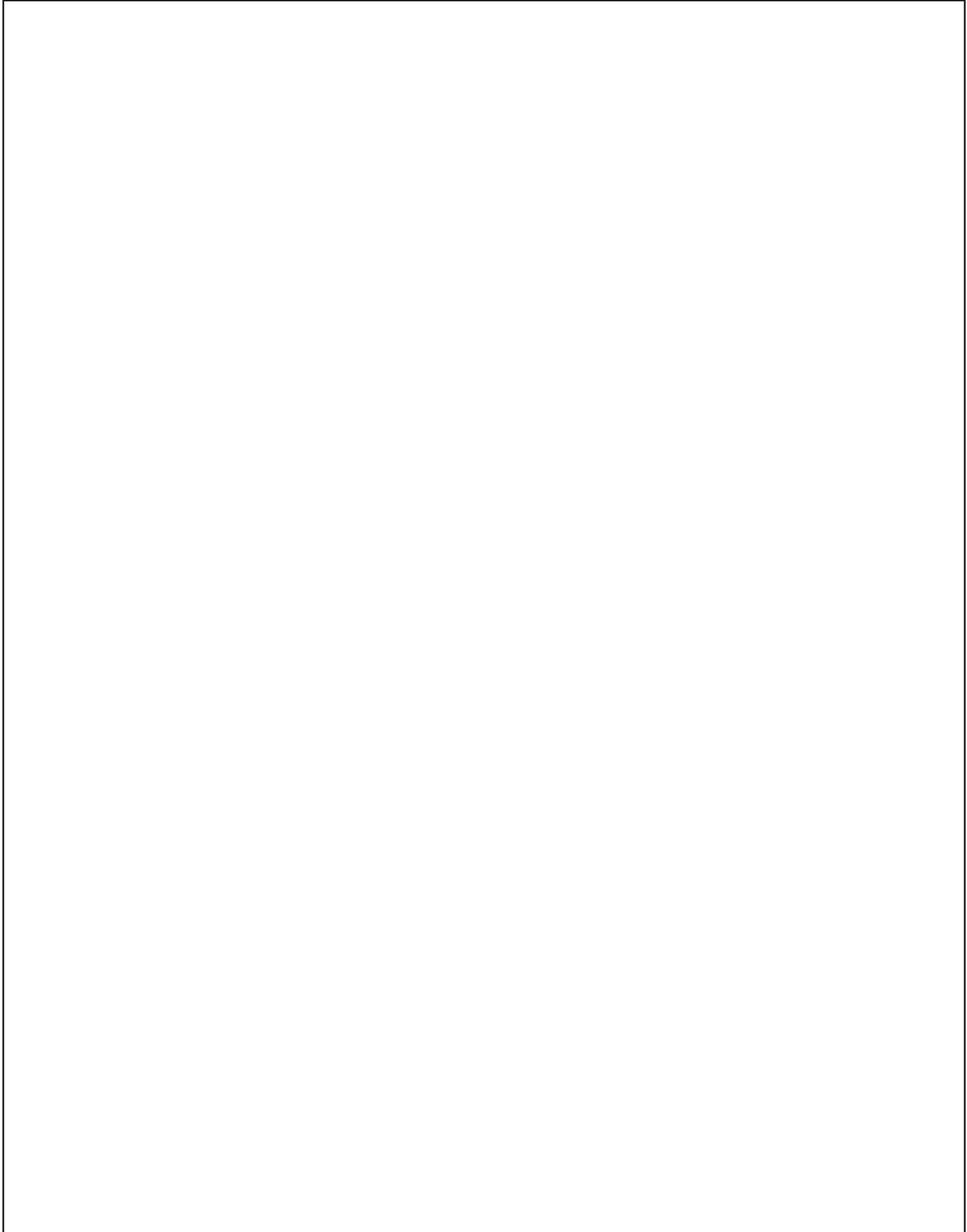



Sinks / mixer taps

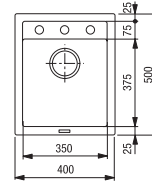



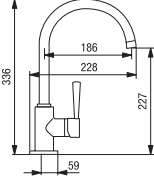

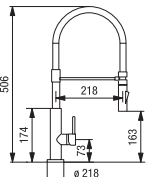
Sinks / mixer taps



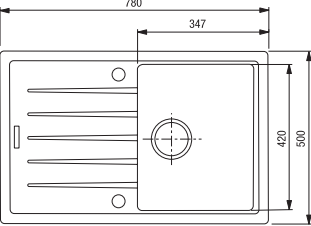

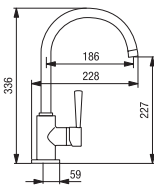
Inset sink with flat installation edge

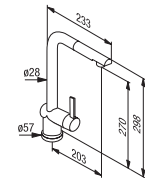
		width	Item	universal
   	<p>Built-in sink granite in the set</p> <p>black External dimensions: 400 x 500 mm 1 basin 350 x 375 x 200 mm including tap hole Cutout size 380 x 480 mm Basin height incl. outlet fitting: 329 mm 3 1/2 inch eccentric outlet fitting in stainless steel to change on-site 3 1/2 inch eccentric outlet fitting in black</p> <p>(from 45 cm sink unit)</p> <p>+ lever mixer tap Black matt high pressure swivel outlet 360° flexible connections, mixer head with ceramic washers, low-noise, replaceable 35 mm cartridge 5-year manufacturer's guarantee</p> <p><i>Set consisting of: ZSG 40 S + ZSZ G1 S + ZM 127 SM</i></p>	400	ZSSM 40 S4	88
 	<p>Built-in sink granite in the set</p> <p>same as above, but + lever mixer tap Black matt high pressure flexible swivel outlet 360° flexible connections, mixer head with ceramic washers, Doubly adjustable spray jet Soft-Touch hose, black low-noise, replaceable 25 mm cartridge 5-year manufacturer's guarantee</p> <p><i>Set consisting of: ZSG 40 S + ZSZ G1 S + ZM 126 SM</i></p>	400	ZSSM 40 S5	102
 	<p>Built-in sink granite in the set</p> <p>same as above, but + lever mixer tap black high pressure with pull-out outlet swivel outlet 360° Central bolting, premounted pipes Long-lasting ceramic regulator unit Smooth-running cartridge with scald protection Energy-saving Cold Start technology Anti-limescale aerator 10-year manufacturer's warranty 15-year manufacturer's warranty on supplies of spare parts</p> <p><i>Set consisting of: ZSG 40 S + ZSZ G1 S + ZM 133 S</i></p>	400	ZSSM 40 S6	108

Inset sink with flat installation edge

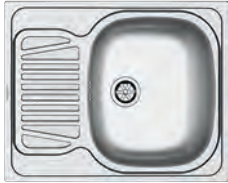
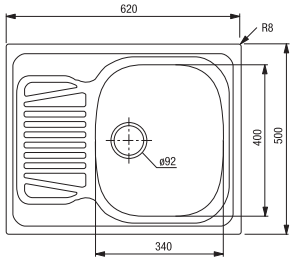
		width	Item	universal
 	<p>Built-in sink granite in the set</p> <p>black External dimensions: 780 x 500 mm 1 basin 347 x 420 x 205 mm Tap holes pre-punched Cutout size 765 x 485 mm Reversible Basin height incl. outlet fitting: 334 mm</p> <p>3 1/2 inch eccentric outlet fitting in stainless steel to change on-site 3 1/2 inch eccentric outlet fitting in black (from 50 cm sink unit)</p> <p>+ lever mixer tap Black matt high pressure with swivel outlet flexible connections, mixer head with ceramic washers, low-noise, replaceable 35 mm cartridge</p>	755	ZSSM 78 S6	92
 	<p><i>Set consisting of: ZSG 78 S + ZSZG 1 S + ZM 127 SM</i></p> <p>same as above, but + lever mixer tap Black matt high pressure flexible swivel outlet 360° flexible connections, mixer head with ceramic washers, Doubly adjustable spray jet Soft-Touch hose, black low-noise, replaceable 25 mm cartridge 5-year manufacturer's guarantee</p>	755	ZSSM 78 S7	106
 	<p><i>Set consisting of: ZSG 78 S + ZSZ G1 S + ZM 126 SM</i></p> <p>same as above, but + lever mixer tap black with pull-out outlet swivel outlet 360° Central bolting, premounted pipes Long-lasting ceramic regulator unit Smooth-running cartridge with scald protection Energy-saving Cold Start technology Anti-limescale aerator 10-year manufacturer's warranty 15-year manufacturer's warranty on supplies of spare parts</p>	755	ZSSM 78 S8	112
	<p><i>Set consisting of: ZSG 78 S + ZSZ G1 S + ZM 133 S</i></p>			

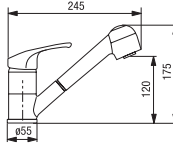
Inset sink with flat installation edge

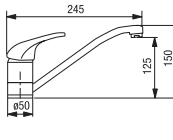
		Item	width	universal	
		<p>Pyramis inset sink set Stainless steel, smooth </p> <p>External dimensions: 620 x 500 mm 1 basin 340 x 400 x 150 mm Without tap hole Cutout dimensions 600 x 480 mm Reversible Basin height incl. pop-up waste set 270 mm 60 mm plug valve including drain and overflow set (from 45 cm sink unit)</p> <p>+ lever mixer tap with pullout spray head chrome-plated high pressure with flexible swivel outlet flexible connections quick fitting system, mixer head with ceramic washers, with pullout spray head, adjustment from spray to normal</p> <p><i>Set consisting of: ZS625IX + ZM400C</i></p> <p><i>Please study local regulations before ordering.</i> <i>Please note: The hot and cold mix is in the body of the tap, and not in the spout outlet.</i></p>	<p>Matt NEW</p> <p>580</p>	<p>ZSSM 625 IX1</p>	<p>41</p>
		<p>same as above, but + lever mixer tap chrome-plated high pressure with swivel outlet flexible connections mixer head with ceramic washers,</p> <p><i>Set consisting of: ZS625IX + ZM100C</i></p> <p><i>Please study local regulations before ordering.</i> <i>Please note: The hot and cold mix is in the body of the tap, and not in the spout outlet.</i></p>	<p>Matt NEW</p> <p>580</p>	<p>ZSSM 625 IX2</p>	<p>36</p>
		<p>same as above, but + lever mixer tap chrome-plated high pressure with swivel outlet flexible connections quick fitting system, mixer head with ceramic washers, low-noise, replaceable 35 mm cartridge</p> <p><i>Set consisting of: ZS625IX + ZM70C</i></p>	<p>Matt NEW</p> <p>580</p>	<p>ZSSM 625 IX3</p>	<p>43</p>

Inset sink with flat installation edge

		width	Item	universal
	<p>Pyramis inset sink set </p> <p>stainless steel External dimensions: 755 x 480 mm 1 basin 340 x 400 x 150 mm 3 1/2 inch eccentric outlet fitting Cutout size 735 x 460 mm Reversible Basin height incl. pop-up waste set 270 mm (from 45 cm sink unit)</p>	Polished <small>NEW</small>	755 ZSSM 755 IX5	55
	<p>+ lever mixer tap chrome-plated high pressure with swivel outlet flexible connections with internal fittings in ceramic, hot-water safety valve Shaft attachment</p> <p><i>Set consisting of: ZS 755 IX1 + ZM 100 C</i></p>			
	<p>same as above, but + lever mixer tap chrome-plated high pressure with flexible swivel outlet flexible connections mixer head with ceramic washers, with pull-out outlet adjustable protection against scalding</p> <p><i>Set consisting of: ZS 755 IX1 + ZM 101 C</i></p>	Polished	755 ZSSM 755 IX3	68
	<p>same as above, but + lever mixer tap chrome-plated high pressure with swivel outlet flexible connections quick fitting system, mixer head with ceramic washers, low-noise, replaceable 35 mm cartridge</p> <p><i>Set consisting of: ZS755IX1 + ZM70C</i></p>	Polished	755 ZSSM 755 IX4	62

Inset sink with flat installation edge

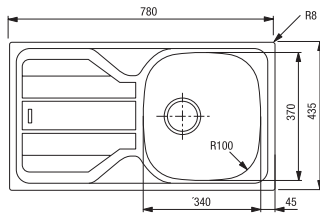
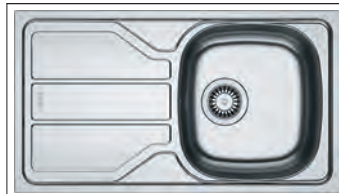

Franke inset sink set



stainless steel
 External dimensions: 780 x 435 mm
 1 basin 340 x 370 x 150 mm
 Basin height incl. outlet fitting: 227 mm
 3 1/2 inch strainer valve incl. outlet- and overflow fitting
 cutout size 760 x 415 mm
 Reversible

(from 45 cm sink unit)

+ lever mixer tap
 chrome-plated
 high pressure
 with swivel outlet
 flexible connections
 mixer head with ceramic washers,

Set consisting of: ZS 783 IX + ZM 100 C

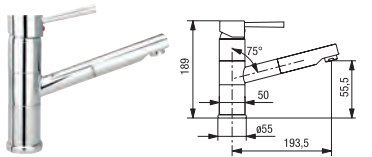
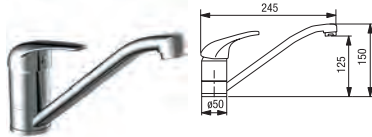

same as above, but
 + lever mixer tap
 chrome-plated
 high pressure
 with flexible swivel outlet
 flexible connections
 mixer head with ceramic washers,
 with pull-out outlet
 adjustable protection against scalding

Set consisting of: ZS 783 IX + ZM 101 C

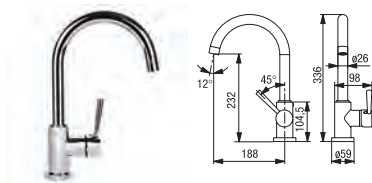

same as above, but
 + lever mixer tap
 chrome-plated
 high pressure
 with swivel outlet
 flexible connections
 quick fitting system,
 mixer head with ceramic washers,
 low-noise, replaceable 35 mm cartridge







Set consisting of: ZS 783 IX + ZM 70 C

	width	Item	universal
Silky matt NEW	755	ZSSM 783 IX1	40
Silky matt NEW	755	ZSSM 783 IX2	53
Silky matt NEW	755	ZSSM 783 IX3	47

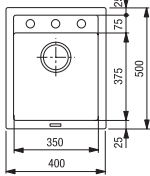

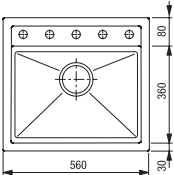

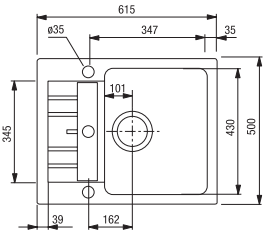
Inset sink with flat installation edge

		width	Item	universal
	<p>Pyramis inset sink set </p> <p>stainless steel External dimensions: 860 x 435 mm 1 basin 365 x 335 x 150 mm Without tap hole cutout size 840 x 415 mm Reversible 60 mm plug valve including drain and overflow set (from 50 cm sink unit) + lever mixer tap chrome-plated high pressure with swivel outlet flexible connections, quick fitting system mixer head with ceramic washers, with pullout spray head, adjustment from spray to normal</p> <p><i>Set consisting of: ZS 861 IX + ZM 400 C</i></p>	Matt <small>NEW</small>	860 ZSSM 861 IX1	35
	<p>same as above, but + lever mixer tap swivel outlet 360° flexible connections, quick fitting system, mixer head with ceramic washers, low-noise, replaceable 35 mm cartridge 5-year manufacturer's guarantee</p> <p><i>Set consisting of: ZS 861 IX + ZM 70 C</i></p>	High pressure <small>NEW</small> chrome-plated	860 ZSSM 861 IX2	37
	<p>same as above, but + lever mixer tap chrome-plated high pressure with swivel outlet flexible connections mixer head with ceramic washers,</p> <p><i>Set consisting of: ZS 861 IX + ZM 100 C</i></p>	Matt <small>NEW</small>	860 ZSSM 861 IX3	30



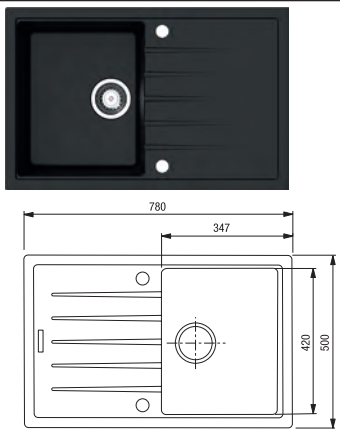

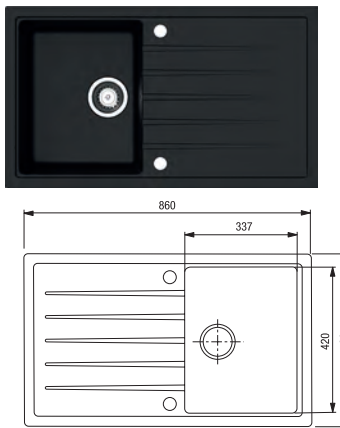
Inset sink granite / composite material

				width		Item	universal
 	<p>Inset sink Granite External dimensions: 400 x 500 mm 1 basin 350 x 375 x 200 mm including tap hole Cutout size 380 x 480 mm Basin height incl. outlet fitting: 329 mm 3 1/2 inch eccentric outlet fitting (from 45 cm sink unit)</p>		black	400	ZSG 40 S	54	
 	<p>Inset sink Granite External dimensions: 560 x 510 mm 1 basin 500 x 360 x 200 mm including tap hole Cutout size 540 x 490 mm Basin height incl. outlet fitting: 329 mm 3 1/2 inch eccentric outlet fitting (from 60 cm sink unit)</p>		black	560	ZSG 56 S	67	
 	<p>Inset sink Granite External dimensions: 615 x 500 mm 1 basin 347 x 430 x 198 mm including tap hole Cutout size 595 x 480 mm Reversible Basin height incl. outlet fitting: 333 mm 3 1/2 inch eccentric outlet fitting (from 50 cm sink unit)</p>		black	560	ZSG 62 S	65	



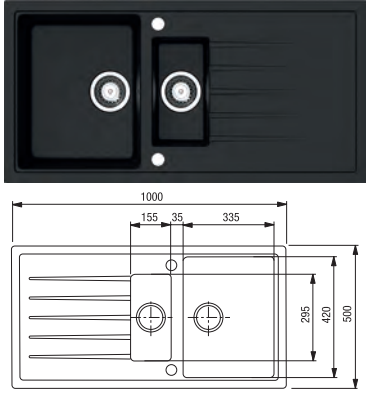

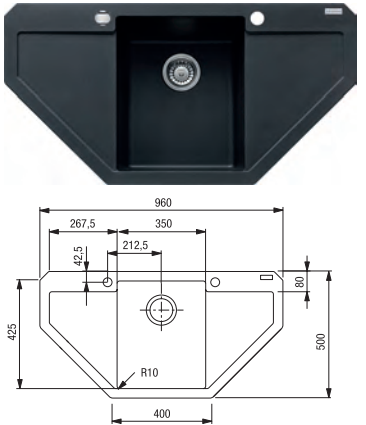

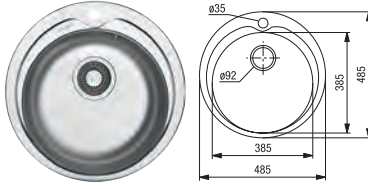

Inset sink granite / composite material

		width	Item	universal
	<p>Inset sink Granite External dimensions: 780 x 500 mm 1 basin 347 x 420 x 205 mm including tap hole Cutout size 765 x 485 mm Reversible Basin height incl. outlet fitting: 334 mm 3 1/2 inch eccentric outlet fitting (from 50 cm sink unit)</p>	780	ZSG 78 S	58
	<p>Suitable additions: Valve set to retrofit, black Strainer basket and overflow plus eccentric control in black <i>To suit:</i> ZSG 40 S, ZSG 56 S, ZSG 62 S, ZSG 78 S, ZSG 86 S</p>		ZSG G 1S	9
	<p>Inset sink Granite External dimensions: 860 x 500 mm 1 basin 337 x 420 x 205 mm including tap hole cutout size 840 x 480 mm Reversible Basin height incl. outlet fitting: 334 mm 3 1/2 inch eccentric outlet fitting (from 50 cm sink unit)</p>	860	ZSG 86 S	69
	<p>Suitable additions: Valve set to retrofit, black Strainer basket and overflow plus eccentric control in black <i>To suit:</i> ZSG 40 S, ZSG 56 S, ZSG 62 S, ZSG 78 S, ZSG 86 S</p>		ZSG G 1S	9

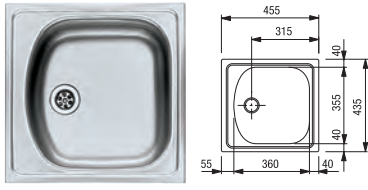

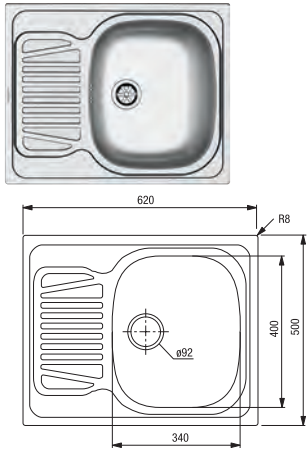

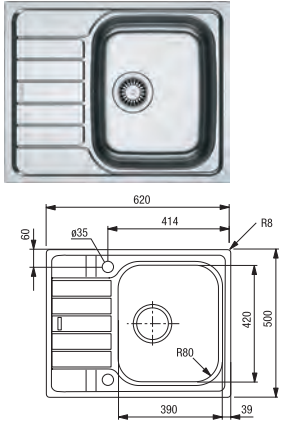



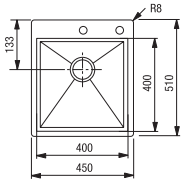

Inset sink granite / composite material

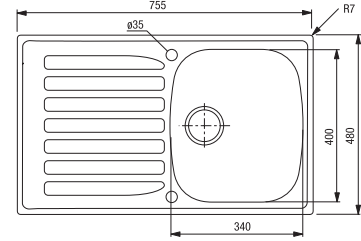
		Item		width	universal	
	<p>Inset sink Granite External dimensions: 1000 x 500 mm 1 basin 335 x 420 x 205 mm 1 waste basin 155 x 295 x 146 mm including tap hole cutout size 980 x 480 mm Reversible Basin height incl. outlet fitting: 334 mm 3 1/2 inch eccentric outlet fitting (from 60 cm sink unit)</p>		black	1000	ZSG 100 S	83
	<p>Suitable additions: Valve set to retrofit, black Strainer basket and overflow plus eccentric control in black <i>To suit:</i> ZSG 100 S</p>				ZSZ G 2S	26
	<p>Franke corner inset sink  Fragranit+ External dimensions: 960 x 500 mm 1 basin 350 x 425 x 200 mm Tap holes pre-punched cutout according to template Basin height incl. outlet fitting 290 mm 3 1/2 inch eccentric outlet fitting suitable for corner sink base unit 900 x 900 mm</p>		black	960	ZSG 96 S	110

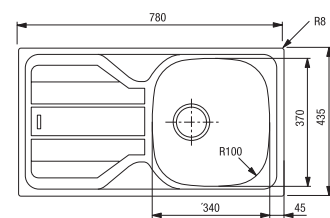
Inset sink stainless steel

		width	Item	universal
	<p>Pyramis inset round sink </p> <p>Polished stainless steel</p> <p>with tap ledge External dimensions: Ø485 mm, 1 basin Ø385 x 163 mm including tap hole Cutout size Ø465 mm 92 mm strainer basket valve including drain and overflow set (from 45 cm sink unit)</p>	Polished <small>NEW</small>	485 ZS 49 IX	26
	<p>Franke inset sink </p> <p>stainless steel External dimensions: 455 x 435 mm 1 bowl 360 x 355 x 140 mm Without tap hole cutout size 435 x 415 mm Reversible Basin height incl. pop-up waste set 270 mm 1 1/2 inch plug valve incl. outlet- and overflow fitting minimum built-in width 380 mm (from 45 cm sink unit)</p>	Matt	455 ZS 45 E	16
	<p>Pyramis inset sink Stainless smooth </p> <p>External dimensions: 620 x 500 mm 1 basin 340 x 400 x 150 mm Without tap hole Cutout dimensions 600 x 480 mm Reversible 60 mm plug valve including drain and overflow set (from 45 cm sink unit)</p>	Smooth <small>NEW</small>	620 ZS 625 IX	24
	<p>Franke inset sink </p> <p>stainless steel External dimensions: 620 x 500 mm 1 bowl 340 x 420 x 160 mm 2 tap holes 3 1/2 inch eccentric outlet fitting Cutout dimensions 600 x 480 mm Reversible Basin height incl. outlet fitting: 238 mm (from 45 cm sink unit)</p>	Smooth <small>NEW</small>	620 ZS 626 IX	42

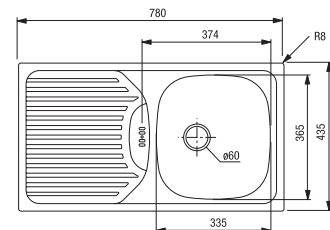

Inset sink stainless steel

		Item	width	universal	
 	<p>Inset sink</p> <p>stainless steel External dimensions: 450 x 510 mm 1 basin 400 x 400 x 200 mm Tap ledge with 2 tap holes Cutout size 435 x 495 mm Basin height incl. outlet fitting: 329 mm 3 1/2 inch eccentric outlet fitting (from 50 cm sink unit)</p>	Flat rim Polished	450	ZS 45 FIX2	80
 	<p>Pyramis inset sink </p> <p>External dimensions: 755 x 480 mm stainless steel 1 basin 340 x 400 x 150 mm 2 tap holes 3 1/2 inch eccentric outlet fitting Cutout size 735 x 460 mm Reversible Basin height incl. pop-up waste set 270 mm (from 45 cm sink unit)</p>	Polished	755	ZS 755 IX1	43
 	<p>Franke inset sink </p> <p>stainless steel External dimensions: 780 x 435 mm 1 basin 340 x 370 x 150 mm Basin height incl. outlet fitting: 227 mm 3 1/2 inch strainer valve incl. outlet- and overflow fitting cutout size 760 x 415 mm Reversible (from 45 cm sink unit)</p>	Silky matt 	780	ZS 783 IX	28
 	<p>Pyramis inset sink </p> <p>stainless steel External dimensions: 780 x 435 mm 1 basin 335 x 365 x 150 mm Without tap hole cutout size 760 x 415 mm Reversible 60 mm plug valve including drain and overflow set (from 45 cm sink unit)</p>	Smooth 	780	ZS 781 IX	18

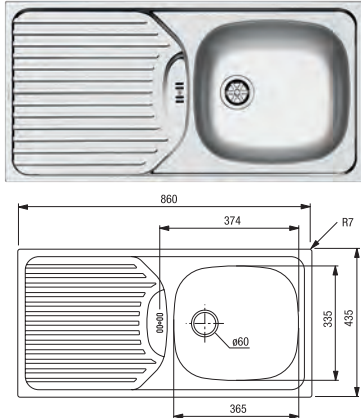
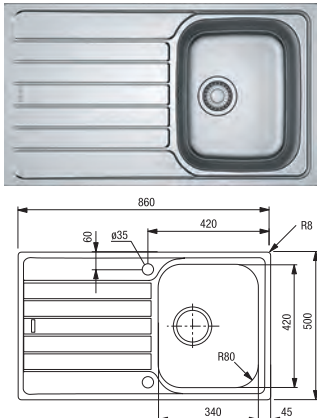
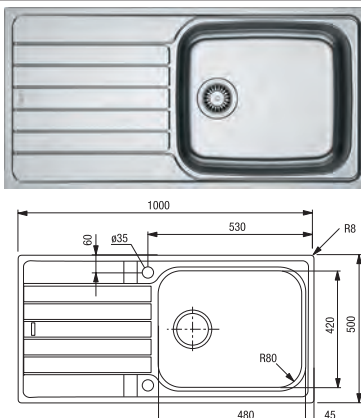
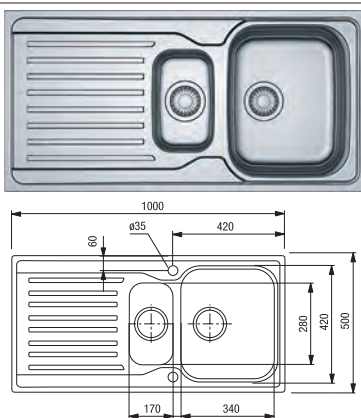

Inset sink stainless steel

		width	Item	universal
	<p>Pyramis inset sink</p> <p>PYRAMIS Kitchen Inspirations</p> <p>stainless steel External dimensions: 860 x 435 mm 1 basin 365 x 335 x 150 mm Without tap hole cutout size 840 x 415 mm Reversible 60 mm plug valve including drain and overflow set (from 50 cm sink unit)</p>	Smooth <small>NEW</small>	860 ZS 861 IX	18
	<p>Franke inset sink</p> <p>FRANKE</p> <p>stainless steel External dimensions: 860 x 500 mm 1 bowl 340 x 420 x 160 mm 2 tap holes cutout size 840 x 480 mm Reversible Basin height incl. outlet fitting: 235 mm 3 1/2 inch eccentric outlet fitting (from 45 cm sink unit)</p>	Smooth <small>NEW</small>	860 ZS 863 IX	43
	<p>Franke inset sink with extra large basin</p> <p>FRANKE</p> <p>stainless steel External dimensions: 1000 x 500 mm 1 basin 420 x 480 x 160 mm 2 tap holes cutout size 980 x 480 mm Reversible Basin height incl. outlet fitting: 238 mm 3 1/2 inch eccentric outlet fitting (from 60 cm sink unit)</p>	Smooth <small>NEW</small>	1000 ZS 101 IX	52
	<p>Franke 1 1/2 basin inset sink</p> <p>FRANKE</p> <p>stainless steel External dimensions: 1000 x 500 mm 1 bowl 340 x 420 x 160 mm 1 waste basin 270 x 180 x 80 mm Without tap hole cutout size 980 x 480 mm Reversible Basin height incl. outlet fitting: 235 mm 3 1/2 inch strainer valve incl. outlet- and overflow fitting Minimum installed width: 560 mm (from 60 cm sink unit)</p>	Matt	1000 ZS 973 IX	48

Accessories for sinks

		width		Item	universal
	<p>Space-saving waste and trap assembly</p> <p>suitable for all sinks waste pipe Ø 50 mm with connection to dishwasher</p> <p>Required if waste bin is built in. white</p>			ZSZ 1 G	5
	<p>Cover</p> <p>for tap holes Ø 35 mm</p> <p>chrome-plated</p>			ZSZ 2 C	2
	<p>Adhesive sealing tape for worktop</p> <p>Aluminium tape for sealing cut edges for hob and sink cut-outs</p> <p>Width: 50 mm</p>	<p>Length 5 metres</p> <p>Length 50 metres</p>	<p>5000</p> <p>50000</p>	<p>ZVA 5 M</p> <p>ZVA 50 M</p>	<p>2</p> <p>12</p>

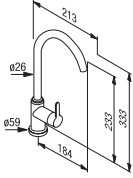
Taps

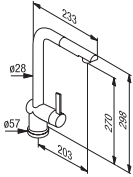
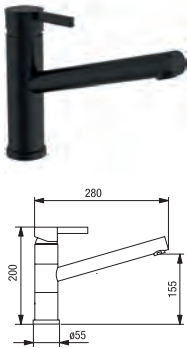
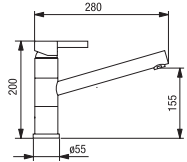
				width		Item	universal
 <p>MADE IN GERMANY</p> 	<p>Lever mixer tap</p> <p>high pressure swivel outlet 150° Central bolting, premounted pipes Long-lasting ceramic regulator unit Smooth-running cartridge with scald protection Energy-saving Cold Start technology Anti-limescale aerator</p> <p>10-year manufacturer's warranty 15-year manufacturer's warranty on supplies of spare parts</p> <p><i>Please study local regulations before ordering.</i> <i>Please note: The hot and cold mix is in the body of the tap, and not in the spout outlet.</i></p>	<p>WASSERWERK</p> <p>stainless steel-effect chrome NEW Black matt NEW</p>	ZM 134 E	39			
			ZM 134 C	37			
			ZM 134 S	40			
 <p>MADE IN GERMANY</p> 	<p>Lever mixer tap with pull-out outlet</p> <p>high pressure with pull-out outlet swivel outlet 360° Central bolting, premounted pipes Long-lasting ceramic regulator unit Smooth-running cartridge with scald protection Energy-saving Cold Start technology Anti-limescale aerator</p> <p>10-year manufacturer's warranty 15-year manufacturer's warranty on supplies of spare parts</p> <p><i>Please study local regulations before ordering.</i> <i>Please note: The hot and cold mix is in the body of the tap, and not in the spout outlet.</i></p>	<p>WASSERWERK</p> <p>stainless steel-effect black chrome NEW</p>	ZM 133 E	47			
			ZM 133 S	48			
			ZM 133 C	44			
 <p>MADE IN GERMANY</p> 	<p>Lever mixer tap</p> <p>high pressure swivel outlet 150° Central bolting, premounted pipes Long-lasting ceramic regulator unit Smooth-running cartridge Anti-limescale aerator</p> <p>10-year manufacturer's warranty 15-year manufacturer's warranty on supplies of spare parts</p> <p><i>Please study local regulations before ordering.</i> <i>Please note: The hot and cold mix is in the body of the tap, and not in the spout outlet.</i></p>	<p>WASSERWERK</p> <p>black Matt</p>	ZM 140 S	43			



Taps

		Item		width	universal
	<p>Lever mixer tap</p> <p>chrome-plated</p> <p>high pressure swivel outlet 360° flexible connections, mixer head with ceramic washers, low-noise, replaceable 35 mm cartridge 5-year manufacturer's guarantee</p> <p><i>Please study local regulations before ordering. Please note: The hot and cold mix is in the body of the tap, and not in the spout outlet.</i></p>	35	ZM 99 C		9
	<p>Lever mixer tap</p> <p>High pressure chrome-plated Low pressure chrome-plated</p> <p>swivel outlet 360° flexible connections, mixer head with ceramic washers, low-noise, replaceable 40 mm cartridge 5-year manufacturer's guarantee</p> <p><i>Please study local regulations before ordering. Please note: The hot and cold mix is in the body of the tap, and not in the spout outlet.</i></p>		ZM 100 C ZMN 100 C		14 17
	<p>Lever mixer tap With pull-out spout</p> <p>chrome-plated</p> <p>high pressure with pullout spray head, flexible swivel outlet 90° flexible connections, quick fitting system, mixer head with ceramic washers, adjustment from spray to normal low-noise, replaceable 40 mm cartridge 5-year manufacturer's guarantee</p> <p><i>Please study local regulations before ordering. Please note: The hot and cold mix is in the body of the tap, and not in the spout outlet.</i></p>		ZM 400 C		19
	<p>Lever mixer tap with pull-out outlet</p> <p>chrome-plated</p> <p>high pressure flexible swivel outlet 90° flexible connections mixer head with ceramic washers, with pull-out outlet adjustable protection against scalding low-noise, replaceable 40 mm cartridge 5-year manufacturer's guarantee</p>		ZM 101 C		27
	<p>Lever mixer tap</p> <p>high pressure swivel outlet 360° flexible connections Central bolting Long-lasting ceramic regulator unit Smooth-running cartridge Energy-saving Cold Start technology</p> <p>stainless steel-effect black</p>		ZM 141 E ZM 141 S		23 25

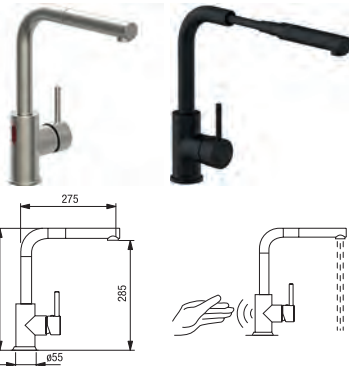
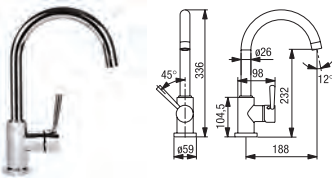
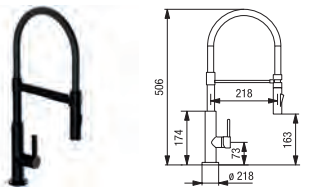
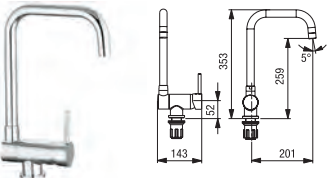
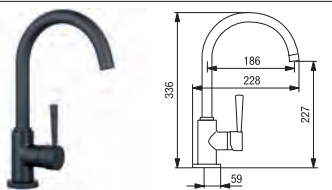
Taps

		width	Item	universal
 <p>Sensor mixer tap with pull-out outlet high pressure Infrared sensor, battery operated (4 x AA) swivel outlet 360° Central bolting, premounted pipes Long-lasting ceramic regulator unit low-noise, replaceable 40 mm cartridge Eco-Click function - saves up to 50% water 5-year manufacturer's guarantee</p>	stainless steel-effect black		ZM 142 E	63
			ZM 142 S	65
 <p>Lever mixer tap swivel outlet 360° flexible connections, quick fitting system, mixer head with ceramic washers, low-noise, replaceable 35 mm cartridge 5-year manufacturer's guarantee</p> <p><i>Please study local regulations before ordering. Please note: The hot and cold mix is in the body of the tap, and not in the spout outlet.</i></p>	High pressure chrome-plated Low pressure chrome-plated		ZM 70 C	21
			ZMN 70 C	25
 <p>Lever mixer tap with pullout spray head high pressure flexible swivel outlet 360° flexible connections, mixer head with ceramic washers, Doubly adjustable spray jet Soft-Touch hose, black low-noise, replaceable 25 mm cartridge 5-year manufacturer's guarantee</p> <p><i>Please study local regulations before ordering. Please note: The hot and cold mix is in the body of the tap, and not in the spout outlet.</i></p>	Chrome black		ZM 126 SM	42
 <p>Lever mixer tap for mounting below windows can be folded down (Height with outlet folded down: 77 mm) high pressure for mounting in front of windows mixer head with ceramic washers, swivel outlet 360° flexible connections, Shaft attachment low-noise, replaceable 40 mm cartridge 5-year manufacturer's guarantee</p> <p><i>Please study local regulations before ordering. Please note: The hot and cold mix is in the body of the tap, and not in the spout outlet.</i></p>	chrome-plated		ZM 124 C	31
 <p>Lever mixer tap high pressure swivel outlet 360° flexible connections, mixer head with ceramic washers, low-noise, replaceable 35 mm cartridge 5-year manufacturer's guarantee</p>	black Matt		ZM 127 SM	28

Taps, Accessories for mixer taps

		Item		width	universal
		<p>KLUDI-mixer tap </p> <p>with internal fittings in ceramic, hot-water safety valve, swivel outlet 360° flexible connections, Fast assembly system 5-year manufacturer's guarantee</p> <p><i>Please study local regulations before ordering. Please note: The hot and cold mix is in the body of the tap, and not in the spout outlet.</i></p>	<p>High pressure chrome-plated Low pressure chrome-plated</p>	<p>ZM 92 C ZM 90 C</p>	<p>43 51</p>
		<p>KLUDI-mixer tap with pull-out outlet </p> <p>high pressure with pull-out outlet with internal fittings in ceramic, hot-water safety valve, swivel outlet 110° Shaft attachment 5-year manufacturer's guarantee</p> <p><i>Please study local regulations before ordering. Please note: The hot and cold mix is in the body of the tap, and not in the spout outlet.</i></p>	<p>chrome-plated</p>	<p>ZM 85 C</p>	<p>73</p>
		<p>KLUDI-mixer tap for fitting in front of window (bayonet) </p> <p>can be pulled out / folded down high pressure for fitting in front of window with internal fittings in ceramic, hot-water safety valve, swivel outlet 360° flexible connections, Shaft attachment 5-year manufacturer's guarantee</p> <p><i>Please study local regulations before ordering. Please note: The hot and cold mix is in the body of the tap, and not in the spout outlet.</i></p>	<p>chrome-plated</p>	<p>ZM 86 C</p>	<p>70</p>
	<p>Hose extension for mixer taps</p>	<p>300 500</p>	<p>ZMZ 4 ZMZ 5</p>	<p>2 2</p>	

Notes

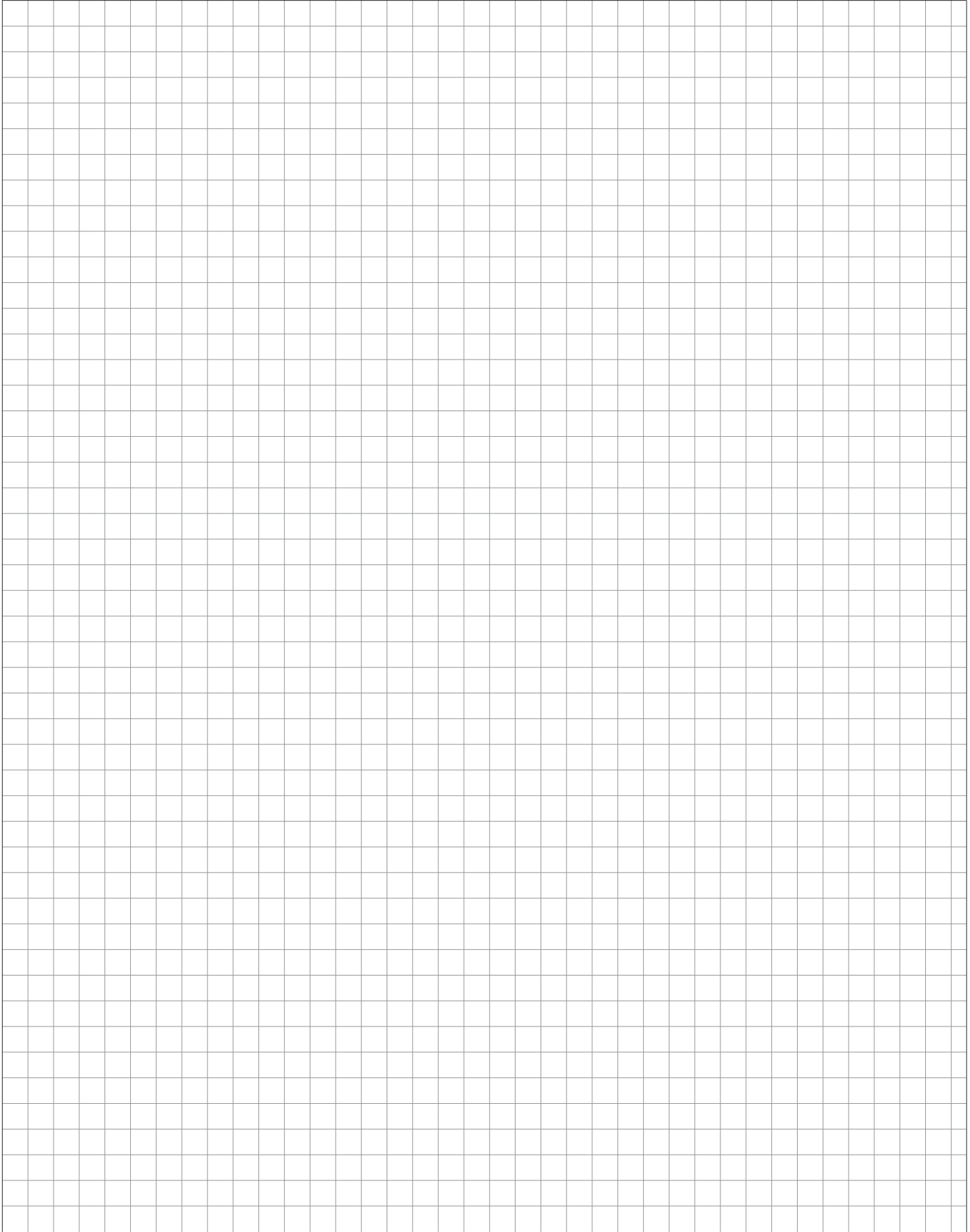

Miscellaneous accessories

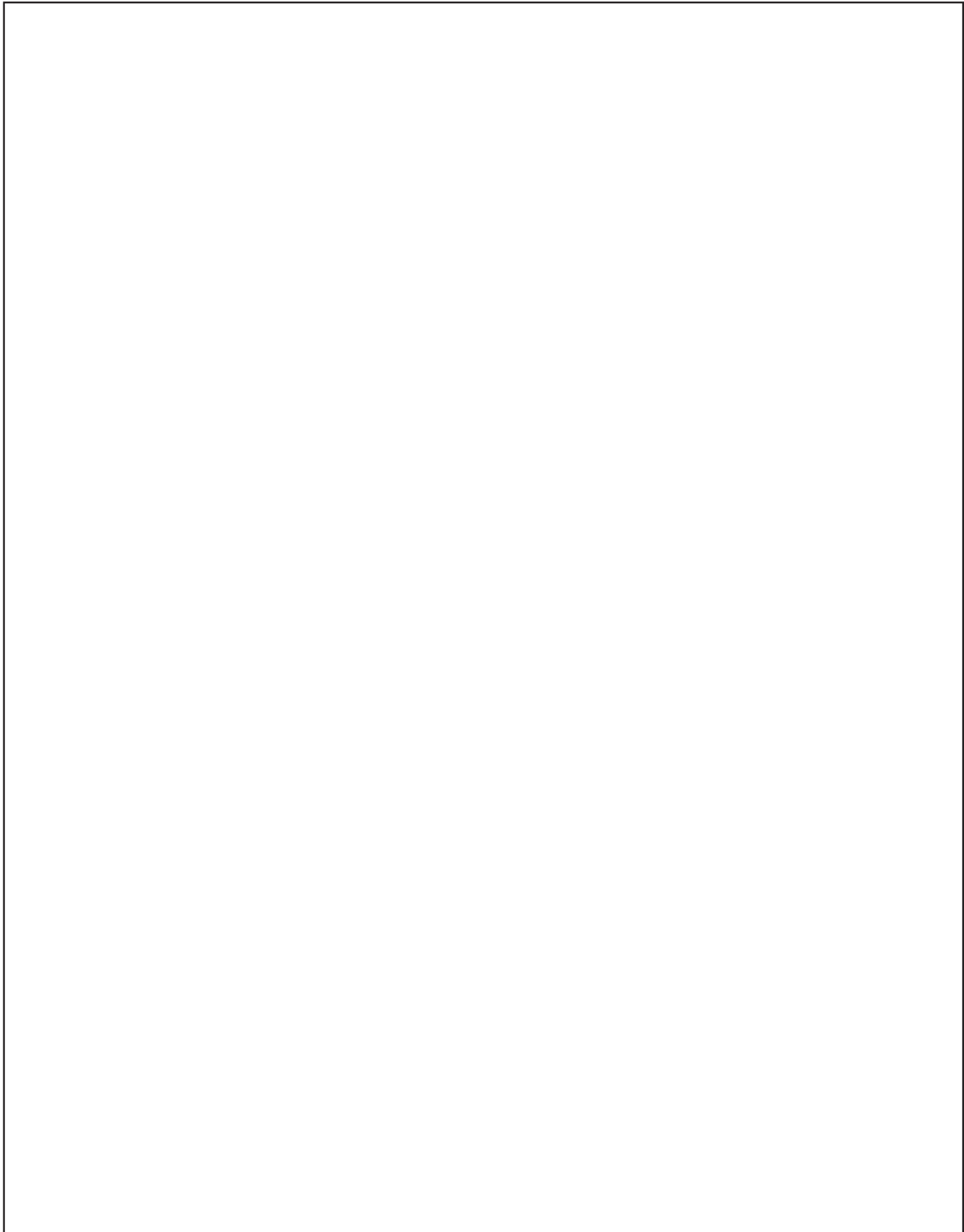

Miscellaneous accessories







Miscellaneous accessories





Other accessories

				Item	universal
		width			
 <p>Add-on towel rail aluminium Surface brushed stainless steel effect Overhang at front: 37 mm</p> <p>Adjust to the front thickness with the enclosed felt strip <i>Cannot be used with fitted strip handle.</i></p>	300 mm	300	ZH 320 E	8	
	500 mm	500	ZH 520 E	13	
 <p>Add-on towel rail black Surface brushed stainless steel effect Overhang at front: 37 mm</p> <p>Adjust to the front thickness with the enclosed felt strip <i>Cannot be used with fitted strip handle.</i></p>	300 mm	300	ZH 320 S	8	
	500 mm	500	ZH 520 S	13	
 <p>Protective strips 326 mm long, side dimensions 5 x 16 mm to protect carcass edges on wall units above hobs contains two pieces</p>	matt chrome		ZV 326 CM	4	
 <p>Heat-protection shelf For base units with drawers on top and hob above. For unit depth 560 mm. Used as contact protection and heat insulation.</p> <p><i>A distance of approx. 20 mm to the bottom edge of the worktop results. During planning and installation, it is essential to observe the safety distances of the electrical appliance manufacturer!</i></p>	300 mm unit width	267	ZV 30	8	
	400 mm unit width	367	ZV 40	8	
	450 mm unit width	417	ZV 45	9	
	500 mm unit width	467	ZV 50	9	
	600 mm unit width	567	ZV 60	10	
	800 mm unit width	767	ZV 80	11	
	900 mm unit width	867	ZV 90	11	
	1000 mm unit width	967	ZV 100	12	
	1200 mm unit width	1167	ZV 120	13	
 <p>Heat-protection shelf Installed directly above a dishwasher or refrigerator with overlying hob. An induction hob is also possible. For unit depth 560 mm. Used as contact protection and heat insulation.</p> <p><i>A distance of approx. 35 mm to the bottom edge of the worktop results. During planning and installation, it is essential to observe the safety distances of the electrical appliance manufacturer!</i></p>	600 mm unit width		600 ZV 601	13	
 <p>Drip tray silver-grey for raised dishwashers</p>			ZVGS 60	4	

Other accessories

				width	Item	universal
	Vapour guard above dishwashers 90 mm deep, 1.5 mm thick	stainless steel-effect for width 450	449	ZV 449	3	
		stainless steel-effect for 600 mm width	599	ZV 599	3	
	Adhesive sealing tape for worktop Aluminium tape for sealing cut edges for hob and sink cut-outs <i>Width: 50 mm</i>	Length 5 metres	5000	ZVA 5 M	2	
		Length 50 metres	50000	ZVA 50 M	12	
	Heat shield strips Metal for oven apertures Set comprising: left and right strip	stainless steel-effect for 600 mm width		ZV 1866	2	
	Cooker power supply cable 5 x 2.5 mm ² 2000 mm long			ZH 200	4	
	Energy box to connect the hob, cooker/oven Rewireable with WAGO clamps on the inside IP rating for the entire product: IP20 Material Box: Laminate, self-extinguishing Box colour: black 7035, colour of cables and coupling: black The cable entry is provided via 3 membranes (IP54), internal cable grip A further membrane/cable inlet is provided for additional use / with internal cable grip All live components are tested and certified Technical specifications: Connection / current input and output: max. load 11 kW (with symmetrical distribution) 2.0 m H05VV-F 5G2.5 mm ² for connection to cooker connector box; ultrasonically sealed strands; max. 3x16A, 400V, 3-phase (current input: supply lead) 2.0m H05VV-F 4G2.5mm ² for hob; preassembled with ultrasonically sealed strands; max. 2x16A, 400V, 2-phase (current output 1; hob) 2.00 H05VV-F 3G1.5mm ² with protected coupling (CEE 7/3; to IEC60884, VDE0620-1) 1x 16A, 230V, 1-phase (current output 2; oven) Dimensions in mm: 150 x 100 x 32.5 <i>The Energy Box acts as an electricity distributor for separately fitted kitchen appliances such as an electric cooker and oven that are powered centrally from an existing cooker connector box.</i> BENEFITS at a glance: very low installation depth of 32.5 mm Can be screwed to wall / rear wall even with the box closed subsequent installation possible quick and easy installation			ZHE B2	19	

Other accessories

		width	Item	universal
	<p>Space-saving waste and trap assembly suitable for all sinks waste pipe Ø 50 mm with connection to dishwasher Required if waste bin is built in. white</p>		ZSZ 1 G	5
	<p>„Water“ installation set consisting of: 1 ball siphon 1 1/2" x 40 mm 1 space-saving connector 1 HT elbow DN40/87 1 HT pipe 40 x 250 mm 1 sink unit reinforcement 1 hose clip 16 - 25 mm, W4 1 HT adapter 40/50 DN 1 flexible connection hose, 3/8" cover ring x 10 mm 1 sealing tape for 5-metre worktop Available within Germany.</p>		MZ SET W	17
	<p>„Water and Electricity“ installation set 1 ball siphon 1 1/2" x 40 mm 1 space-saving connector 1 HT elbow DN40/87 1 HT pipe 40 x 250 mm 1 HT adapter 40/50 DN 1 sink unit reinforcement 1 cooker power supply cable 5 x 2.5 mm² 1 flexible connection hose, 3/8" cover ring x 10 mm 1 hose clip 16 - 25 mm, W4 1 3-way worktop plug socket, 1.5 m connection lead 1 sealing tape for 5-metre worktop Available within Germany.</p>		MZ SET WS	20

Notes

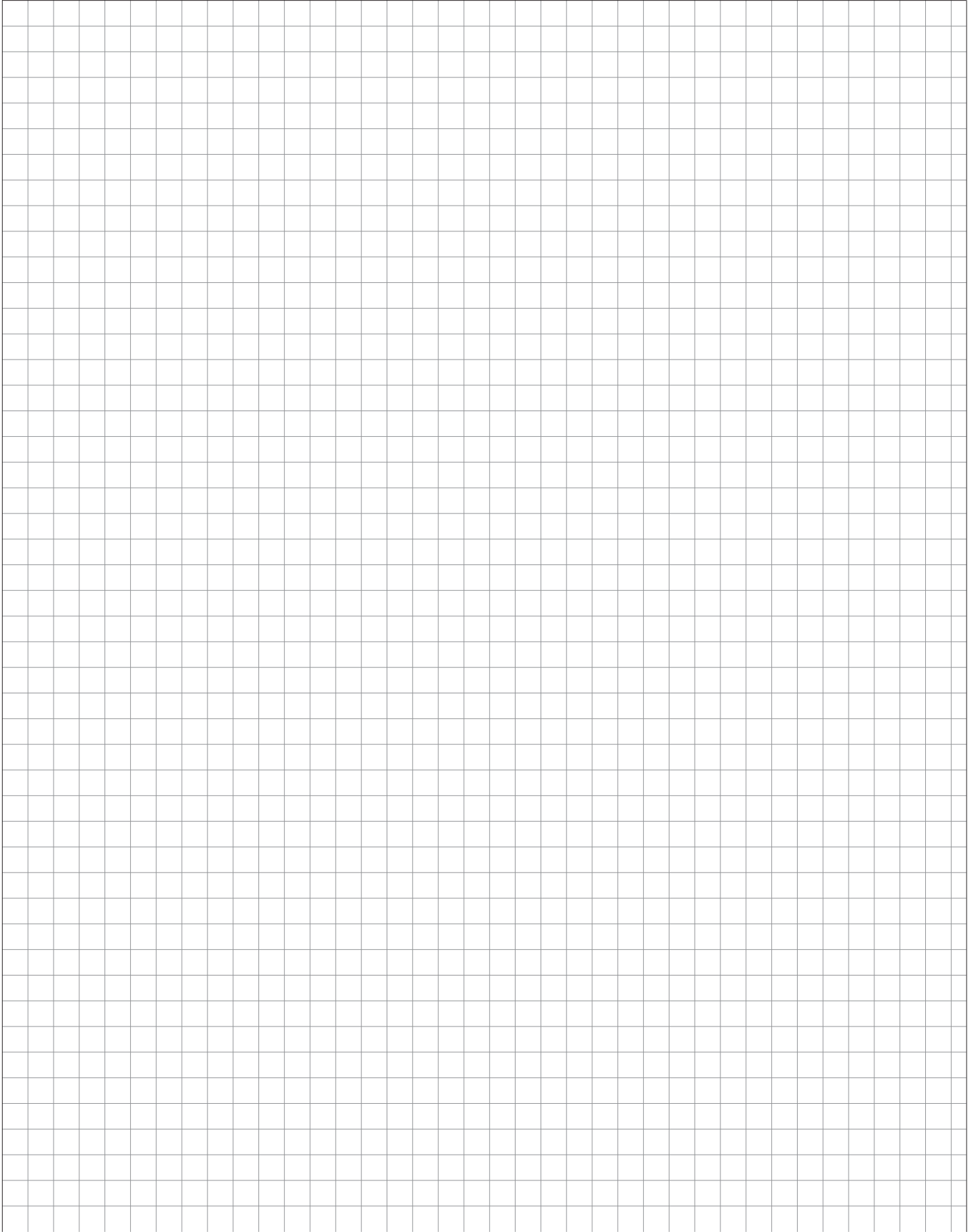

Storage space / utility room

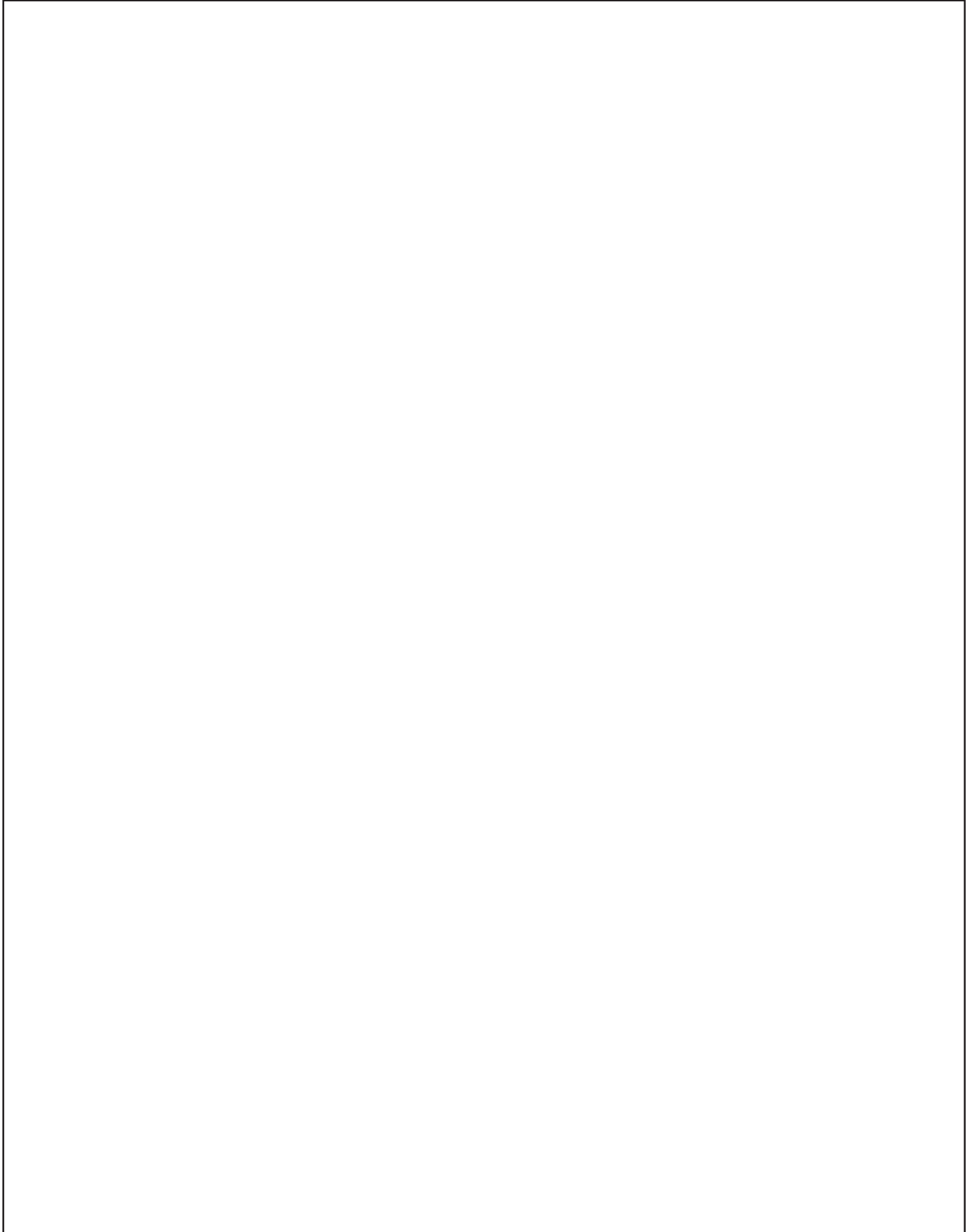



Storage space / utility
room

Storage space / utility
room



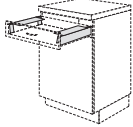

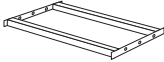



Storage space / utility room

Accessories

	width	Item	universal
 <p>Laundry basket white plastic Capacity 41 litres Dimensions (H x W x D): 304 x 520 x 462 mm <i>Suitable for S 60 01 WK9 and S 60 02 WK9</i></p>	520	ZWK 60	19
 <p>Laundry basket support Clips onto drawer frame 2 items in set</p>		ZISA	11
 <p>Recyclable waste collector Metal housing, powder-coated Frame for recyclables bag made of plastic Swing lid made of plastic Capacity approx. 53 litres mounting to the cabinet base <i>Dimensions (H x W x D): 622 x 340 x 260 mm</i> <i>Suitable for deep drawers from 400 mm width</i></p>	340	ZAA 40 S	33
 <p>Supporting frames for bottle crates, individual silver-grey</p>		ZIGK 60	13





Storage space / utility room

Accessory K-Line side

		width	universal
	Fixing strips 2 items in set Length: 1073 mm silver-grey	ZIZ TP 107	12
	Fixing strips same as above, but Length: 560 mm	ZIZ TP 56	10
	Storage surface 1 each silver-grey Dimensions (W x D x H): 350 x 110 x 65 mm	ZIZ ABL 1	8
	Storage surface with rail 1 each silver-grey Dimensions (W x D x H): 350 x 110 x 65 mm	ZIZ ABL 2	11
	Carry box for cleaning agents with backing strip 1 each silver-grey Box in laminate, white Dimensions (W x D x H): 442 x 160 x 315 mm	ZIZ ABL 3	15
	Backing strip with box 1 each silver-grey Box in laminate, white Dimensions (W x D x H): 350 x 138 x 95 mm	ZIZ ABL 4	9
	Paper roll holder 1 each silver-grey Dimensions (W x D x H): 350 x 120 x 65 mm	ZIZ ROL 1	8
	„Rollinero“ holder with tear-off edge 1 each silver-grey Dimensions (W x D x H): 350 x 145 x 70 mm	ZIZ ROL 2	16
	Hanging hook rail with 5 hooks 1 each silver-grey Dimensions (W x D x H): 350 x 32 x 50 mm	ZIZ HLE	6

Storage space / utility room

Accessory K-Line side

		width	universal
 <p>Hook rail to screw onto side with 5 hooks 1 each silver-grey Width: 350 mm</p>	ZIZ HLS		6
 <p>Hook rail for ceiling attachment with 5 hooks 1 each silver-grey Width: 350 mm</p>	ZIZ HLD		6
 <p>Screw-on holder for vacuum cleaner hose or PET bag 1 each silver-grey Dimensions (W x D x H): 150 x 70 x 63 mm</p>	ZIZ HSS		6
 <p>Screw-on utensils box 1 each silver-grey Dimensions (W x D x H): 255 x 140 x 300 mm</p>	ZIZ BOX 1		13

Notes

