

IMPULS
KÜCHEN

LOOK BOOK 2025

Neuheiten im Fokus.
Focus on new releases.

NEUE FRONTEN

NEW FRONTS

1200

Preisgruppe 1
Price group 1

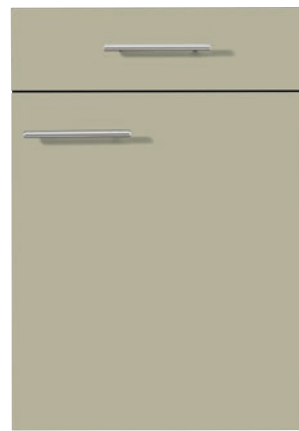

158 Salbeigrün
158 Sage green



2200

Preisgruppe 2
Price group 2

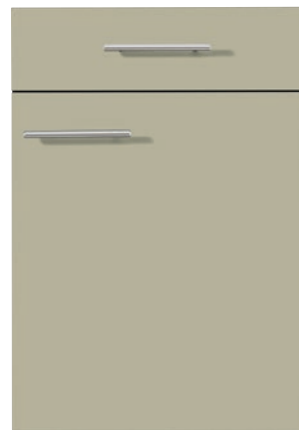

159 Salbeigrün
159 Sage green



161 Space Grey
161 Space Grey

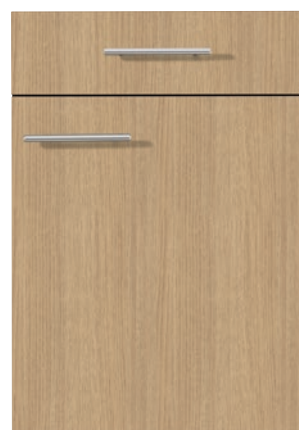

162 Eiche-Nb.
Summerfield
162 Summerfield
oak effect

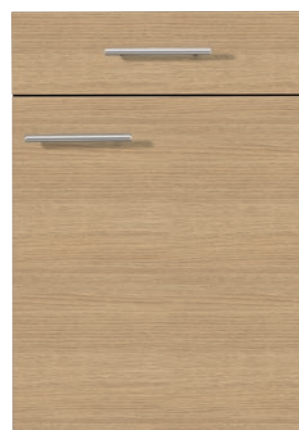

163 Eiche-Nb.
Summerfield
163 Summerfield
oak effect



A

Frontklasse A
Frontfarben, in denen es Wangen, Korpus und Sockelblenden gibt

Front class A
Front colours in which panels, carcass and plinth panels are available

B

Frontklasse B
Frontfarben, in denen es Wangen gibt

Front class B
Front colours in which panels are available

C

Sortiment C
Grifflos Fronten, die auch im Sortiment C / Grifflos möglich sind.

Product range C
Handleless fronts that are also available without handles in Range C.

NEUE FRONTEN

NEW FRONTS

3150*

Preisgruppe 3
Price group 3

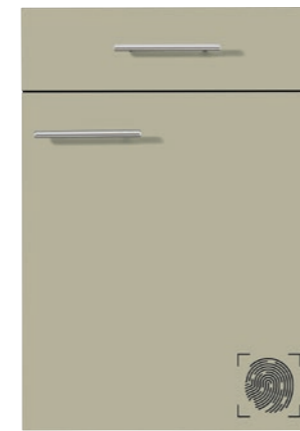

164 Salbeigrün
164 Sage green

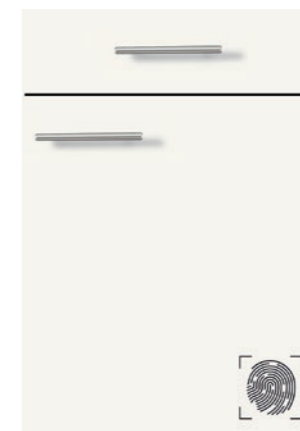

167 Weiß
167 White

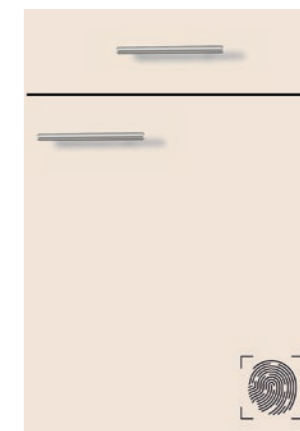

168 Magnolienweiß
168 Magnolia white

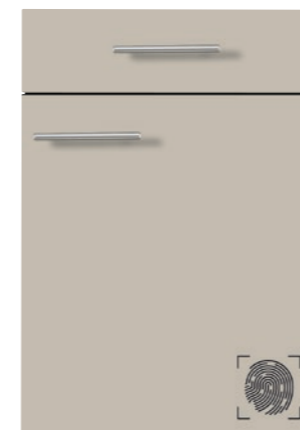

169 Kieselgrau
169 Pebble grey



171 Cappuccino
171 Cappuccino

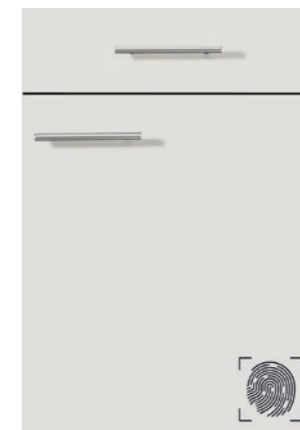

172 Space Grey
172 Space grey



Oberfläche mit Antifingerprint
Anti-fingerprint surface

7500

Preisgruppe 6
Price group 6



173 Weiß Hochglanz
(Frontstärke 19 mm)
173 High-gloss white
(front thickness 19 mm)



7810 CK

Preisgruppe 7
Price group 7



397 Träger Landhaus modern
(Frontstärke 19 mm)
397 Substrate,
country-style modern
(front thickness 19 mm)

* = Neue Oberfläche
* = new surface

RAHMENGLASTÜR FÜR 1200 + 2200

FRAMED GLASS DOOR FOR 1200 + 2200



Beidseitig mit edelstahlfarbigem Glashalteprofil.
Mögliche Wahlgläser beachten.
Montage Bügel- und Stangengriffe nur vertikal.
Stainless steel coloured glass retaining profile on both sides.
Note the available glass choices.
D-handles and bar handles can only be installed vertically.

701 Rahmenglastür in Frontfarbton
701 Framed glass door in front colour

NEUE KORPUSFARBEN

NEW CARCASE COLOURS



160 Eiche-Nb. Summerfield
160 Summerfield oak effect

NEUE SICHTSEITENFARBEN

NEW VISIBLE SIDE COLOURS

NEW VISIBLE SIDE COLOURS

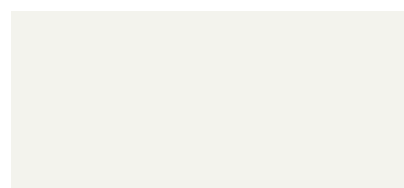

167 Weiß
167 White

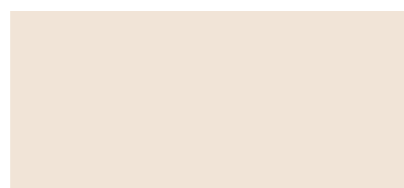

168 Magnolienweiß
168 Magnolia white



169 Kieselgrau
169 Pebble grey



172 Space Grey
172 Space grey

NEUE SOCKELFARBEN

NEW PLINTH COLOURS

NEW PLINTH COLOURS



158 Salbeigrün
158 Sage green



160 Eiche-Nb. Summerfield
160 Summerfield oak effect

NEUE WANGENFARBEN

NEW PANEL COLORS

NEW PANEL COLORS



160 Eiche-Nb. Summerfield
160 Summerfield oak effect



158 Salbeigrün
158 Sage green



164 Salbeigrün*
164 Sage green*

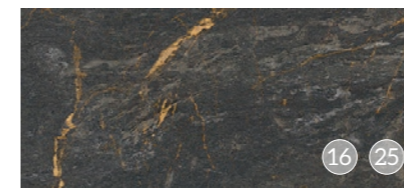

165 Titian
165 Titian



166 Terragrau
166 Terra grey

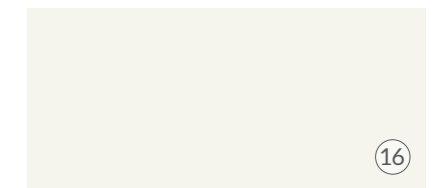

167 Weiß*
167 White*

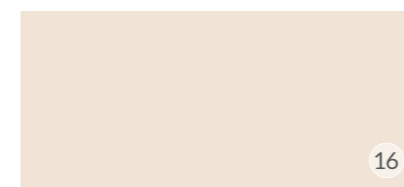

168 Magnolienweiß*
168 Magnolia white*



169 Kieselgrau*
169 Pebble grey*



171 Cappuccino*
171 Cappuccino*

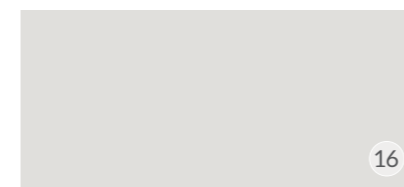

172 Space Grey*
172 Space grey*

Erhältliche Wangendicke:
Available panel thickness:
① 16 mm ② 25 mm
③ 16 mm ④ 25 mm

* = Lack
* = Lacquer

NEUE ARBEITSPLATTEN-DEKORE

NEW WORKTOP DECORS



25 40

160 Eiche-Nb. Summerfield
160 Summerfield oak effect

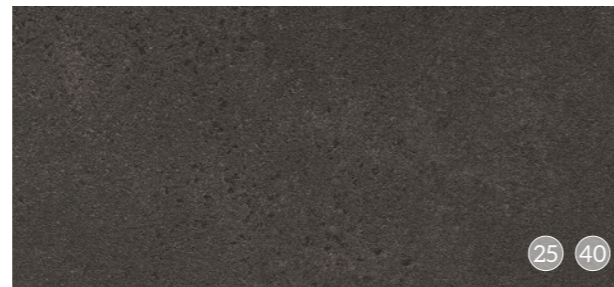

25 40

166 Terragrau
166 Terra grey



25 40

165 Titian
165 Titian

Erhältliche Arbeitsplattendicke:
Available worktop thickness:

25 25 mm 40 40 mm
25 mm 40 mm

Alle neuen Arbeitsplattende-
kore auch als Wange in 16 mm
und 25 mm Stärke erhältlich.
All new worktop decors also
available as panels 16 mm and
25 mm thick.

Neue Arbeitsplatten-Dekore nur in PLS-Ausführung!
New worktop decors only in PLS finish.



NEUE GRIFFE

NEW HANDLES



⌀ 128 mm

783 Muschelgriff Schwarz
783 Shell handle, black



⌀ 160 mm

784 Metallbügelgriff Schwarz
784 Metal D-handle, black



⌀ 160 mm

785 Metallbügelgriff Schwarz
785 Metal D-handle, black



⌀ 160 mm

786 Metallbügelgriff Schwarz
786 Metal D-handle, black



Stilsicher auf ganzer Linie
Stylish in every respect

Das Zusammenspiel von hellen und dunklen Komponenten sorgt immer für einen rundum gelungenen Auftritt. Auf der Bühne zeigt sich die Farbe Grau in all ihren Facetten – und hinterlässt gepaart mit Holzoptiken einen bleibenden Eindruck. Mit Klasse. Mit Eleganz. Mit Stil.

The interplay of light and dark components always makes for a great entrance that takes centre stage. Emerging from the wings, grey plays out all its facets – and, paired with wood-effect surfaces, leaves a lasting impression. Classy. Elegant. Stylish.

FRONT
Eiche-Nb.
Summerfield

FRONT
Oak effect
Summerfield



ARBEITSPLATTE
Terragrau

WORKTOP
Terra grey

KORPUSDEKOR
Kieselgrau

CARCASE DECOR
Pebble grey



UMFELDFARBE
SURROUNDING COLOUR

Hellgrau /
Light grey

Dunkelgrau / Dark grey



SIKKENS

F9.03.76

FN.02.77



EXCITING INSPIRATION

Moodboards bring
ideas to life.

Like a creative compass for interior design: moodboards capture moods and show colour and design trends that harmonise perfectly with each other. They open the door on a new world to live in, one that lets every individual develop freely – and find their own place to feel good in.

INSPIRIERENDE IMPULSE

Moodboards erwecken
Ideen zum Leben.

Wie ein kreativer Kompass für die Inneneinrichtung: Moodboards fangen Stimmungen ein und zeigen, welche Farb- und Designtrends perfekt miteinander harmonieren. Sie öffnen die Tür zu einer neuen Lebenswelt, in der sich jeder frei entfalten kann – und jeder seinen Ort zum Wohlfühlen findet.



Zum Wohlgefühl gehört es dazu, Einrichtungen auf individuelle Bedürfnisse abzustimmen. Genau das ermöglichen wir: Von großzügigen Küchenplanungen für die ganze Familie über verspielte Landhausoptiken bis hin zu gemütlichen Wohnlandschaften – mit uns werden die eigenen vier Wände nach persönlichen Wünschen gestaltet und Lebensräume realisiert, die beeindrucken. Dazu gehören:

- > Loft
- > Familienküche
- > Grifflosküche
- > Büroküche
- > Tiny Kitchen
- > Single-Küche
- > Landhausküche
- > Mietwohnung
- > Modul-Küche
- > Best-Ager-Küche
- > Hauswirtschaftsraum
- > Wohnwände
- > Garderobe

Ob Küche, Wohnzimmer, Hauswirtschaftsraum oder Garderobe: Mit uns wird dem persönlichen Lebensstil Ausdruck verliehen und ein Zuhause kreiert, in dem sich jeder wohl und geborgen fühlt.

UMFELDFAHRE
SUBROUNDING COLOUR

- SIKKEHS
- FR 03.76
- FR 02.77
- FR 04.45

*Von Wärme umgeben
Warmly embraced*

What a feeling! Köstliche Vollkornbrot und warme Handflächen...
What a feeling! Köstliche Vollkornbrot und warme Handflächen...
What a feeling! Köstliche Vollkornbrot und warme Handflächen...

FRONT: Weißlack
FRONT: Warmes Grün
KORPUSFAHRE: Eiche-NL, Sommerfeld
CARCASE DECOR: Oak effect Sommerfeld
ARBEITSPLATTE: Eiche-NL, Sommerfeld
WORKTOP: Oak effect Sommerfeld

*Am Puls der Zeit
Right on trend*

Hier wird es sich auch immer lohnen! Warme Handflächen...
This is where life is truly relaxed! Warm moments of...
This is where life is truly relaxed! Warm moments of...

UMFELDFAHRE
SUBROUNDING COLOUR

- WeiB / White
- Hellgrün / Light grey
- Mittelgrün / Medium grey
- SIKKEHS
- FR 07.69
- FR 15.53

FRONT: Eiche-NL, Sommerfeld
FRONT: Oak effect Sommerfeld
KORPUSFAHRE: Weiß
CARCASE DECOR: White
ARBEITSPLATTE: Marmor Weiß
WORKTOP: Marble white



Feeling good also involves matching interior furnishings to personal preferences and needs. This is precisely what we do best: from spacious kitchen designs for the whole family to enchanting country-kitchen worlds and inviting, cosy homescapes – we have what it takes to shape home environments to reflect personal wishes and realise living spaces that impress. This includes:

- > Loft
- > Family kitchen
- > Handleless kitchen
- > Office kitchen
- > Tiny kitchen
- > Singles kitchen
- > Country-style kitchen
- > Rented apartment
- > Modular kitchen
- > Best-ager kitchen
- > Utility room
- > Living-room wall unit systems
- > Hallway

Whether kitchen, living room, utility room or hallway: we can express personal lifestyle and create a feel-good home that invokes a sense of warmth and belonging for everyone.

SERVICE

SERVICE

Endkundenbelieferung

Vorteile und Nutzen:

- > Keine Einlagerung der Ware
- > Kein Auslagern der Ware
- > Kein Transport der Ware zum Endkunden
- > Kein Vertragen der Ware beim Endkunden
- > Sprechen Sie uns an für weitere Informationen!

Animierte Montageanleitung

Animierte Darstellung der Aufbaureihenfolge und einfache Erklärung der jeweiligen Montageschritte.

Produkt und Erklärvideos

Filmische Darstellung einzelner Produktthemen.

MOODBOARDS

Erweiterung der Moodboards mit den Neuheitentrends 2025.

Musterküchen-Team

Unser Team realisiert individuelle Musterküchen für den Handel. Begleitet wird der gesamte Prozess von der Planung bis zur professionellen Montage. Wir prüfen jede Musterküche auf technische Mach- und Montierbarkeit und stehen unseren Handelspartnern mit einem telefonischen Kundenservice zur Seite.

Customer deliveries

Advantages and benefits:

- > No warehousing of goods
- > No outsourcing of goods
- > No need to transport goods to the customer
- > No transportation of the goods once with the customer
- > Please contact us for further information.

Animated installation instructions

Animated representation of the construction sequence and simple explanation of the assembly steps.

Product and explanatory videos

Film presentation of individual product topics.

MOODBOARDS

New products for 2025 added to the moodboards.

Show kitchens team

Our team creates individual show kitchens for retailers. The entire process is supported, from planning to professional assembly. We check each show kitchen for technical feasibility and ease of assembly, and our customer services team is available to our retail partners by phone.

SERVICE & QUALITÄT

SERVICE & QUALITY

TAK

- > TAK = Technische Auftrags Kontrolle
- > Planungsprüfungen, die im Kundenplanungssystem mittels TAK-Button aufgerufen werden können („Habe ich alles richtig gemacht?“)
- > Dem Kunden werden Planungsfehler aufgezeigt, mit dem Ziel die Bestellqualität zu verbessern
- > Befolgt der Kunde die Hinweise werden Rückfragen vermieden
- > Zeitersparnis für den Verkäufer
- > Lerneffekt

Entladescanning

- > Bestandteil der IMPULS Digitalisierungsstrategie
- > Pilotphase startet in 2024
- > Höhere Kundenzufriedenheit
- > Reklamationsquote verringern
- > Sensibilisierung der Fahrer und der Lagermitarbeiter
- > Klare Rückverfolgbarkeit nach der Anlieferung
- > Schnellere Bearbeitungszeit bei Reklamationen im Kunden-Service-Center (KSC)

VKHB als e-Paper

- > Online abrufbar
- > 24/7
- > Kunden-VKHB mit eigenem Login-Bereich
- > Plattformunabhängig
- > Link kann als reines HTML-Format zur Einbindung in das eigene Intranet zur Verfügung gestellt werden
- > VKHB & E-Geräte-Handbuch

Kurztypenübersicht

- > Schnelleinstieg auf 34 Seiten
- > Hinweise zur Bestellung
- > Maßsystem
- > Meist verplante Schrankartikel je Kategorie
- > Geeignet für Quer- und Neueinsteiger

Abbreviated model guide

- > Quick start on 34 pages
- > Advice on ordering
- > Dimension system
- > Cabinet items most frequently featured per category
- > Suitable for lateral entrants and newcomers

TAK

- > TAK = Technische Auftrags Kontrolle [Technical order check]
- > Planning checks that can be opened in the customer planning system by selecting the TAK button ("Did I get everything right?")
- > The customer is shown planning mistakes with the aim of improving the quality of ordering
- > Customers following the advice given will avoid queries
- > Time saving for the salesperson
- > Learning effect

Offload scanning

- > Part of the digitisation strategy at IMPULS
- > Pilot phase starts in 2024
- > Higher level of customer satisfaction
- > Lower complaints rate
- > Raising awareness among drivers and warehouse staff
- > Clear post-delivery traceability
- > Faster complaints handling at Kunden-Service-Center (KSC) [Customer Service Centre]

Sales manual in e-paper form

- > Can be opened online
- > 24/7
- > Customer sales manual with customer's own login area
- > Platform-governed
- > Link can be provided in dedicated HTML format for incorporating into own intranet
- > Sales manual & e-device manual



Erreichbarkeit Availability



Wir sind für Sie montags bis freitags telefonisch wie folgt erreichbar:
You can reach us by phone Monday to Friday as follows:

- > Deutschsprachig: 8:00 Uhr bis 17:30 Uhr
- > International: 8:00 Uhr bis 17:00 Uhr
- > In German 8:00 am until 5:30 pm
- > International: 8:00 am until 5:00 pm

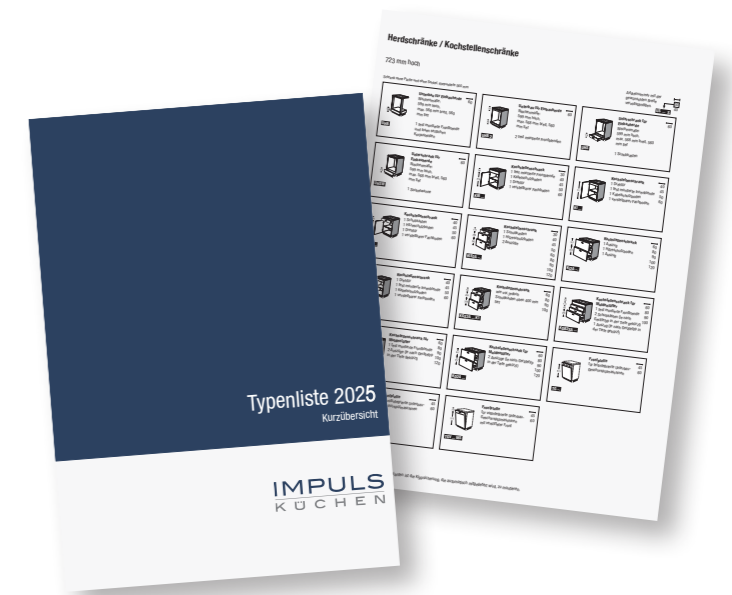

NEUE TYPEN

NEW TYPES

Vervollständigen Sie die Artikelnummer mit der gewünschten Breite
US...S
 Complete the article number by adding the required width

Vervollständigen Sie die Artikelnummer mit der gewünschten Breite
APK...01
 Complete the article number by adding the required width

Unterschranke Base units

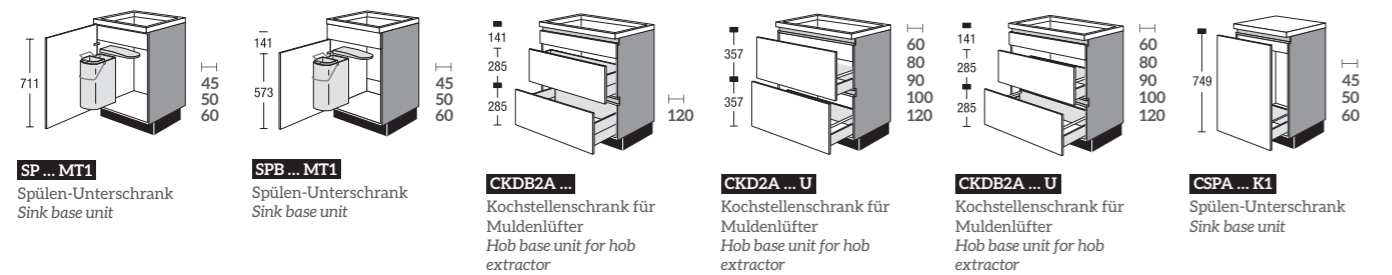
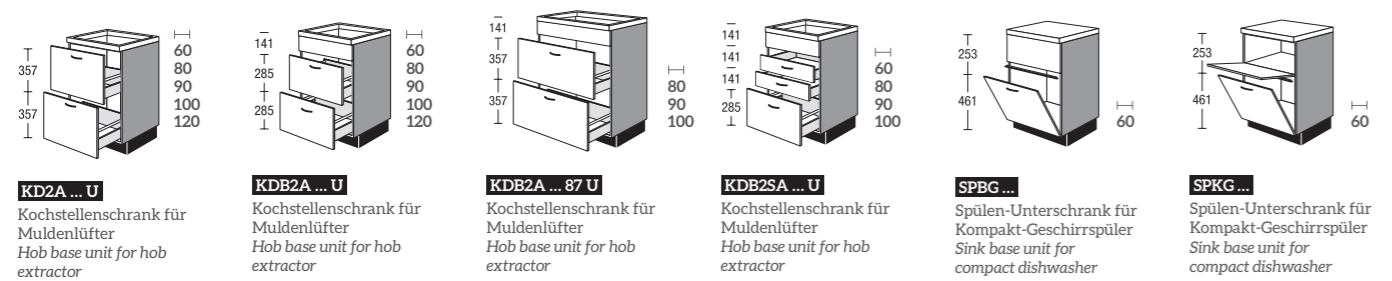
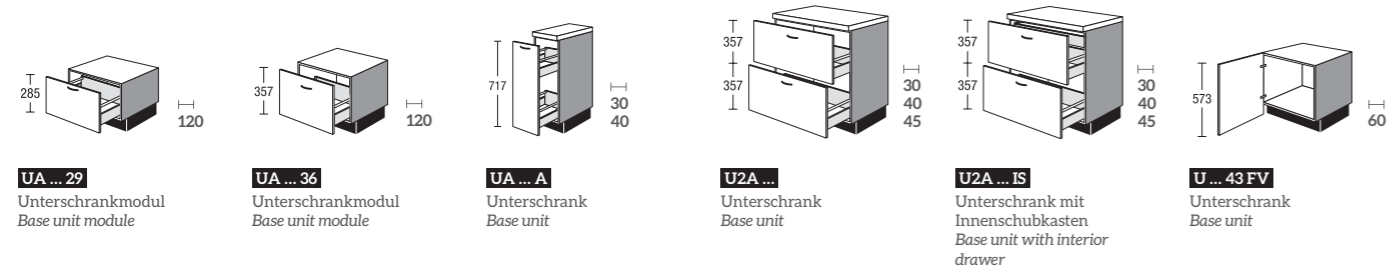

Eckpassleisten Corner filler profiles

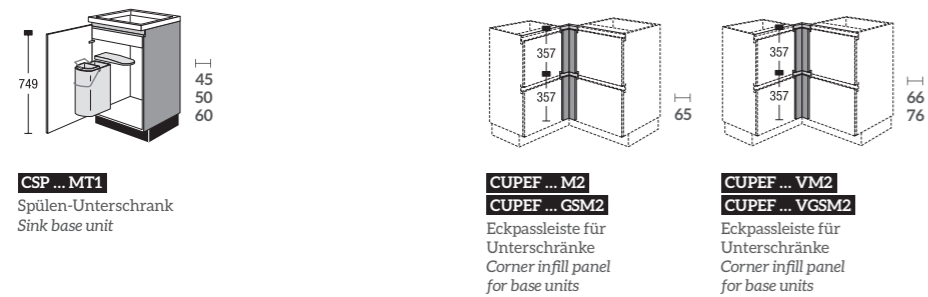

Hängeschrank-Regale Wall shelf units

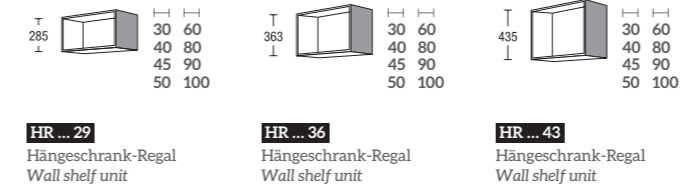

Highboards Highboards

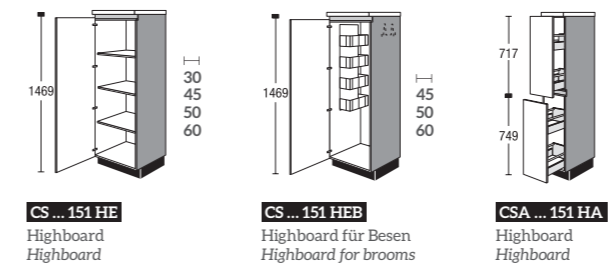
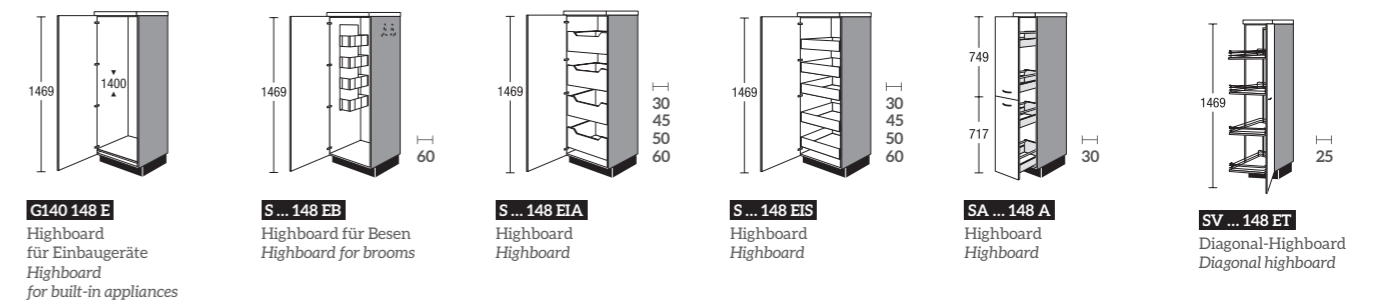

Aufsatzschranke Top-mounted units

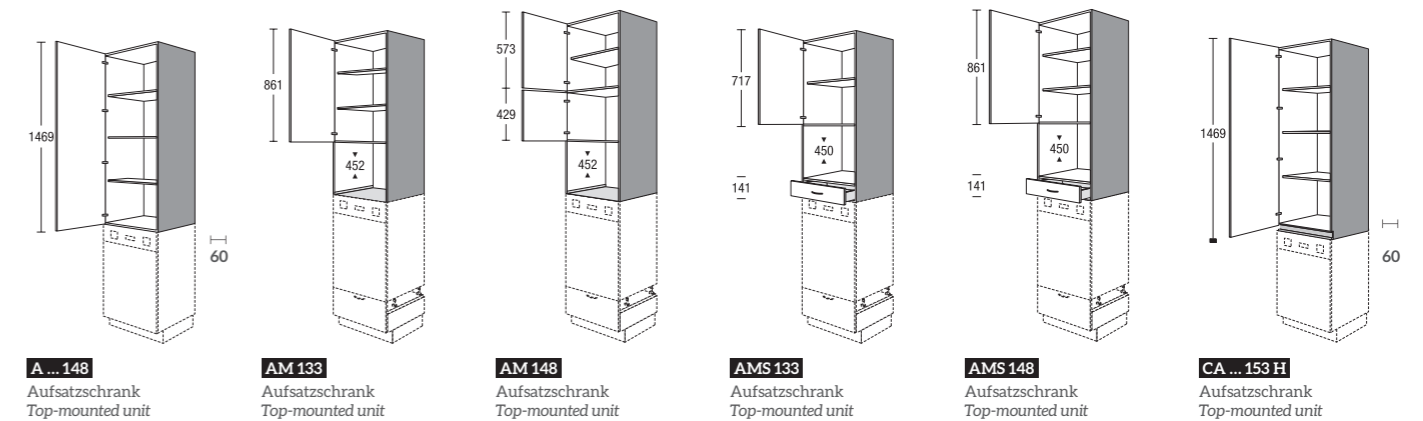

NEUE TYPEN

NEW TYPES

Vervollständigen Sie die Artikelnummer mit der gewünschten Breite
APK...01
 Complete the article number by adding the required width

Vervollständigen Sie die Artikelnummer mit der gewünschten Breite
APK...01
 Complete the article number by adding the required width

Aufsatzschränke Top-mounted units

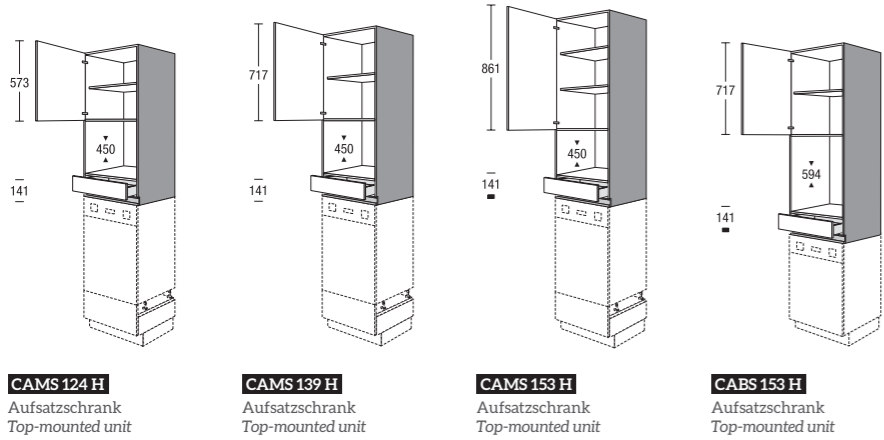

CAMS 124 H Aufsatzschrank Top-mounted unit
CAMS 139 H Aufsatzschrank Top-mounted unit
CAMS 153 H Aufsatzschrank Top-mounted unit
CABS 153 H Aufsatzschrank Top-mounted unit

Seitenschränke Tall units

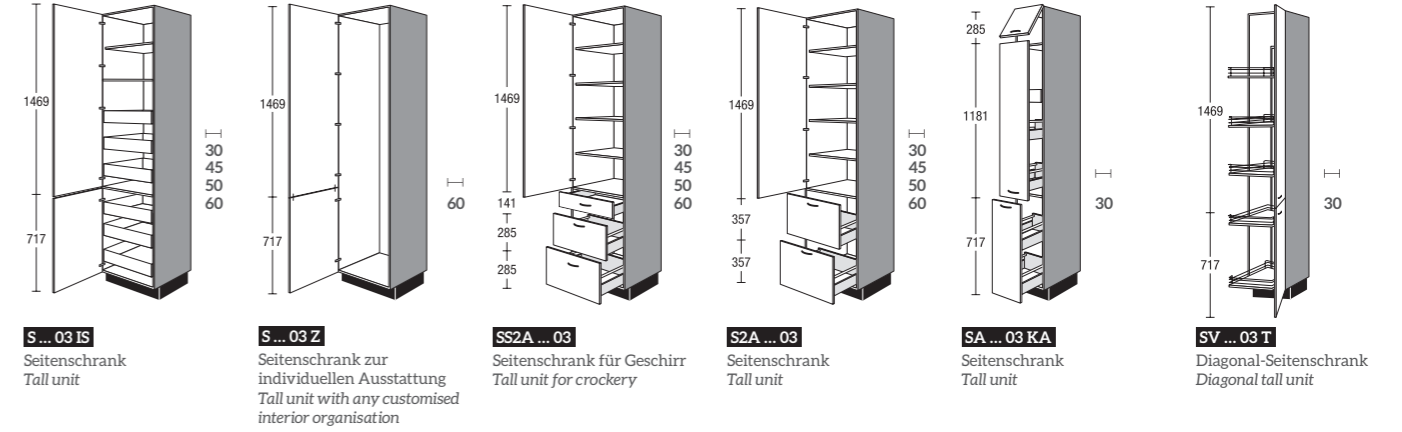

S... 03 IS Seitenschrank Tall unit
S... 03 Z Seitenschrank zur individuellen Ausstattung Tall unit with any customised interior organisation
SS2A... 03 Seitenschrank für Geschirr Tall unit for crockery
S2A... 03 Seitenschrank Tall unit
SA... 03 KA Seitenschrank Tall unit
SV... 03 T Diagonal-Seitenschrank Diagonal tall unit

Seitenschränke Tall units

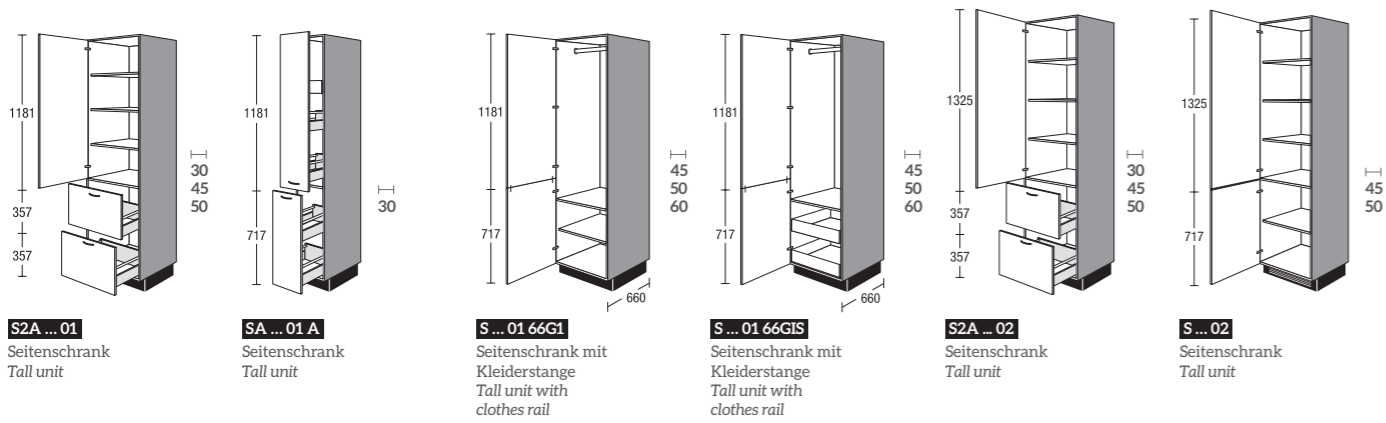

S2A... 01 Seitenschrank Tall unit
SA... 01 A Seitenschrank Tall unit
S... 01 66G1 Seitenschrank mit Kleiderstange Tall unit with clothes rail
S... 01 66GIS Seitenschrank mit Kleiderstange Tall unit with clothes rail
S2A... 02 Seitenschrank Tall unit
S... 02 Seitenschrank Tall unit

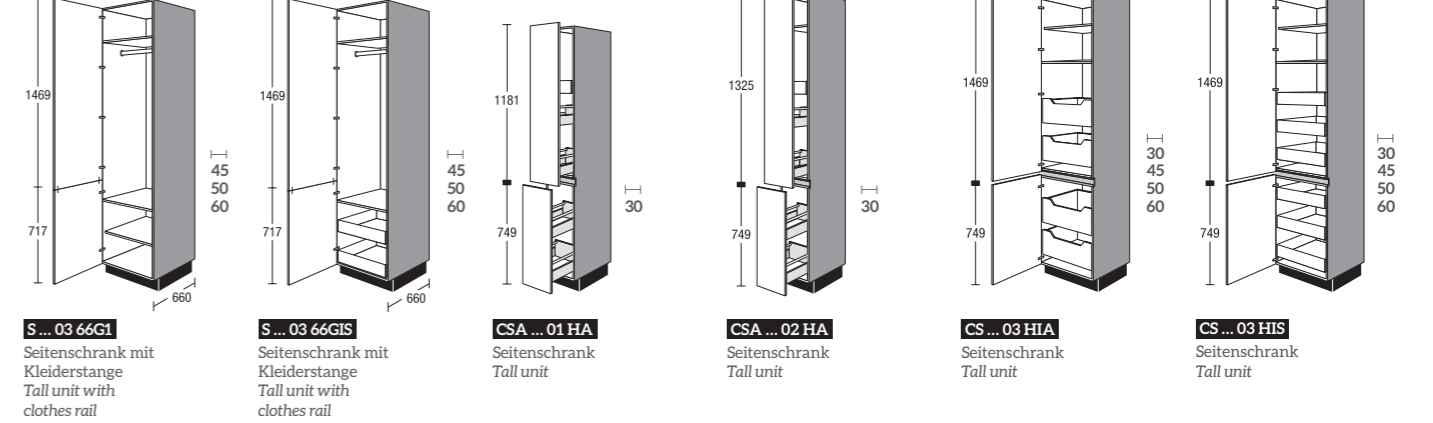

S... 03 66G1 Seitenschrank mit Kleiderstange Tall unit with clothes rail
S... 03 66GIS Seitenschrank mit Kleiderstange Tall unit with clothes rail
CSA... 01 HA Seitenschrank Tall unit
CSA... 02 HA Seitenschrank Tall unit
CS... 03 HIA Seitenschrank Tall unit
CS... 03 HIS Seitenschrank Tall unit

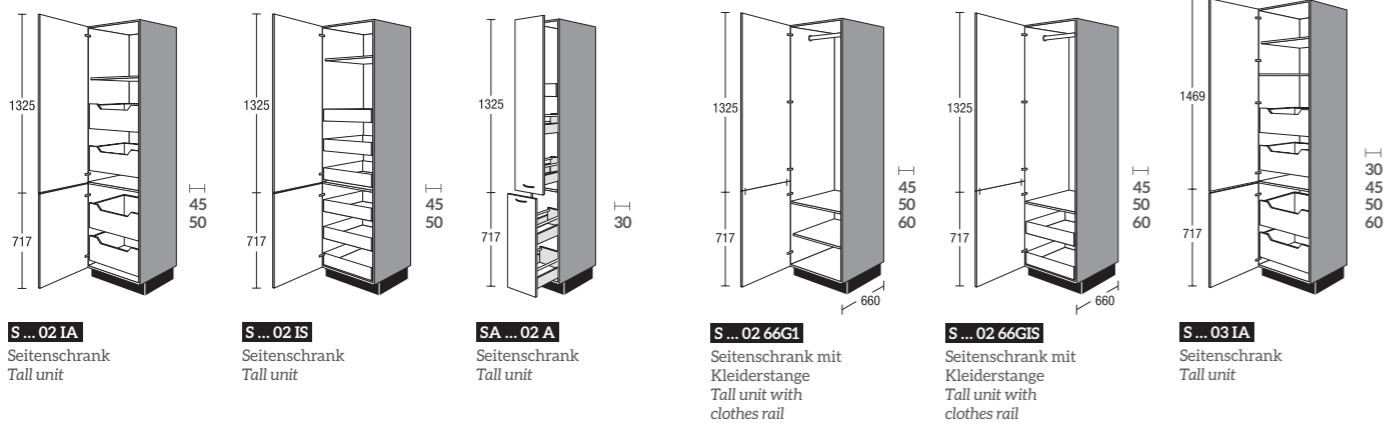

S... 02 IA Seitenschrank Tall unit
S... 02 IS Seitenschrank Tall unit
SA... 02 A Seitenschrank Tall unit
S... 02 66G1 Seitenschrank mit Kleiderstange Tall unit with clothes rail
S... 02 66GIS Seitenschrank mit Kleiderstange Tall unit with clothes rail
S... 03 IA Seitenschrank Tall unit

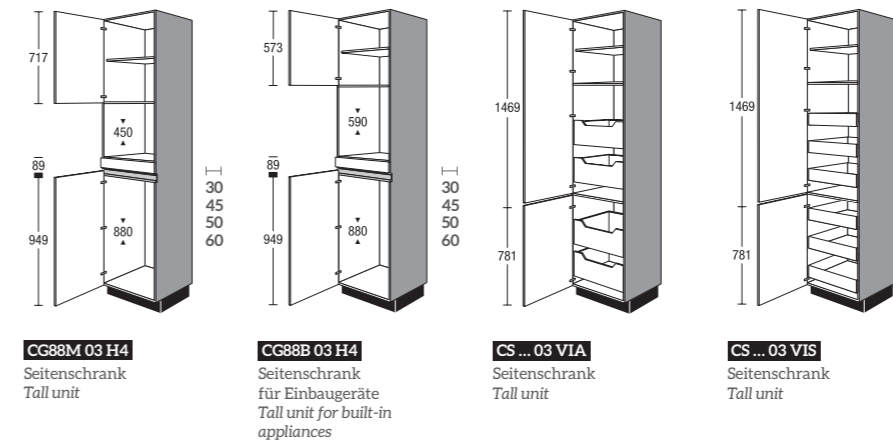

CG88M 03 H4 Seitenschrank Tall unit
CG88B 03 H4 Seitenschrank für Einbaugeräte Tall unit for built-in appliances
CS... 03 VIA Seitenschrank Tall unit
CS... 03 VIS Seitenschrank Tall unit

Abrundung des Sortiments

- > Sortiment C - Ausbau Seitenschränke Höhe 03 (2.259 mm)
- > Sortiment C - Eckpassleiste mit geteilter Front
- > Ausbau Sortiment mit Bauteilhöhe 1469 mm
- > Ausbau Sortiment 120er Auszugsschrank
- > Apothekerschranke mit Auszügen anstelle von Schubkästen
- > Spülenschrank für Kompaktgeschirrspüler
- > Aufsatzschrank für Mikrowelle
- > Weitere Artikelnummern für Kochstellenschränke mit Muldenlüfter mit ungeführter Umluft
- > Anschlagleiste in Farbe Schwarz für Eckhänger
- > Griffleiste: Bei Frontfarben in Schwarz und Grafit in Kombination mit den Griffleisten Schwarz (Nr. 790 und 800) und Anthrazit (Nr. 780) wird immer eine schwarze Kante aufgebracht

Range complements

- > Product range C - upgrade, tall units, height 03 (2,259 mm)
- > Product range C - corner filler profile with split front
- > Range upgrade with 1469 mm component height
- > Range upgrade, 120cm pull-out unit
- > Larder unit with pull-outs instead of drawers
- > Sink base unit for compact dishwasher
- > Top-mounted unit for microwave oven
- > Further article numbers for hob base units with downdraft extractor with non-ducted recirculating air
- > Buffer strip in black for corner wall unit
- > Finger pull: a black edge is always featured on black and graphite fronts in combination with the black (no. 790 and 800) and anthracite (no. 780) finger pull

ZUBEHÖR

ACCESSORIES

Mischbatterien Mixer taps



ZM 134 C



ZM 134 S



ZM 133 C

mit herausziehbarem Auslauf
with pull-out outlet

Spülen Sinks



ZS 625 IX



ZS 626 IX



ZS 49 IX



ZS 101 IX



ZS 781 IX



ZS 783 IX



ZS 861 IX



ZS 863 IX

Einbau-Spüle im Set Inset sink in a set

Set ZSSM 625 IX1



ZS 625 IX

ZM 400 C

Set ZSSM 625 IX2



ZS 625 IX

ZM 100 C

Set ZSSM 625 IX3



ZS 625 IX

ZM 70 C

Set ZSSM 783 IX1



ZS 783 IX

ZM 100 C

Set ZSSM 783 IX2



ZS 783 IX

ZM 101 C

Set ZSSM 783 IX3



ZS 783 IX

ZM 70 C

Set ZSSM 861 IX1



ZS 861 IX

ZM 400 C

Set ZSSM 861 IX2



ZS 861 IX

ZM 100 C

Set ZSSM 861 IX3



ZS 861 IX

ZM 70 C

Abfallbehälter Waste containers



ZAT 45 19G

Abfallbehälter mit 2 Behältern aus Kunststoff, Gesamtvolumen 19 Liter
Waste bin with 2 plastic containers, total volume 19 litres



ZAA 60 31 N

Wertstofftrennsystem
2 Behälter je 17 Liter, jeweils mit Deckel
1 Behälter 8 Liter mit Deckel
1 Bodenplatte
Recycling waste sorting system
2 containers 17 litres each, each with lid
1 container 8 litres with lid
1 base panel

NACHHALTIGKEIT UND UMWELT

SUSTAINABILITY
AND ENVIRONMENT



Sauber: eigene Stromerzeugung Clean: energy generated in-house

- > Wir haben ca. 11.900 Solarmodule an unserem Hauptsitz in Brilon verbaut
- > Die installierte Leistung der Solarmodule beträgt 4.615 kW
- > Der Ertrag beläuft sich auf ca. 4,25 Mio kWh Strom pro Jahr
- > Damit sparen wir jährlich etwa 2.750 t CO₂ ein (ja nach Erzeugung variiert dieser Wert)

- > We have installed approx. 11,900 solar modules at our headquarters
- > The solar modules produce an output of 4,615 kW
- > This yields approx. 4.25 million kWh of electricity per annum
- > Each year, it saves us around 2,750 tonnes of CO₂ (figure may vary depending on amount of electricity produced)



Gutes Klima:
DGM-Emissionslabel
Climate welfare:
DGM emission label

- > Nähere Infos unter www.dgm-moebel.de
- > Further details at www.dgm-moebel.de



Konsequent: Recycling
Across the board:
recycling wherever possible

- > Nähere Infos unter www.recycling-kontor.koeln
- > For further details, go to www.recycling-kontor.koeln



Nachhaltig gut:
PEFC-zertifiziert
Perfectly sustainable:
PEFC-certified

- > Nähere Infos unter <https://pefc.de>
- > Further details at <https://pefc.de>



GEPRÜFTE QUALITÄT TESTED QUALITY



RAL-Gütezeichen
„Goldenes M“
RAL „Golden M“
quality label

- > Nähere Infos unter www.dgm-moebel.de
- > Further details at www.dgm-moebel.de



GS-Gütesiegel
GS quality label

- > Nähere Infos unter www.certipedia.com
- > Further details at www.certipedia.com



Möbel
„Made in Germany“
Furniture
“Made in Germany”

- > Nähere Infos unter www.dgm-moebel.de
- > Further details at www.dgm-moebel.de

AUSLAUF

DISCONTINUED

FRONTEN

FRONTS

1200

Preisgruppe 1
Price group 1



935 Seeahorn-Nb.
935 Sea maple effect

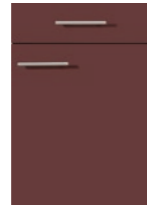

122 Cranberry
122 Cranberry

2200

Preisgruppe 2
Price group 2



139 Seeahorn-Nb.
139 Sea maple effect

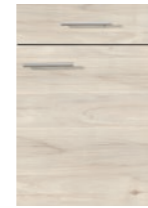

944 Seeahorn-Nb.
944 Sea maple effect

3150

Preisgruppe 3
Price group 3



902 Weiß
902 White



903 Magnolienweiß
903 Magnolia white



927 Kieselgrau
927 Pebble grey



124 Cappuccino
124 Cappuccino



955 Space Grey
955 Space grey

4050

Preisgruppe 3
Price group 3



925 Schwarz Hochglanz
925 High-gloss black

4150

Preisgruppe 4
Price group 4



949 Weiß
949 White

4250

Preisgruppe 4
Price group 4



125 Schwarz
125 Black

7500

Preisgruppe 6
Price group 6



789 Weiß Hochglanz
789 High-gloss white

7810 CK

Preisgruppe 7
Price group 7



393 Träger Landhaus modern
393 Substrate, country-style modern

GRIFFE

HANDLES



764 Metallbügelgriff Schwarz
Metal D-handle black



768 Metallbügelgriff Kupfer-Optik
Metal D-handle copper effect



769 Metallbügelgriff Schwarz
Metal D-handle black



773 Metallbügelgriff Stahl-Optik gebürstet
Metal D-handle steel effect, brushed



774 Bügelgriff Anthrazit gebürstet/Schwarz
D-handle anthracite black/brushed

KORPUS

CARCASE



870 Seeahorn-Nb.
870 Sea maple effect



850 Havanna Eiche-Nb.
850 Havana oak effect



CK332 Cranberry
CK332 Cranberry

SICHTSEITENFARBEN

VISIBLE SIDE COLOURS



902 Weiß
902 White



927 Kieselgrau
927 Pebble grey



925 Schwarz Hochglanz
925 High-gloss black

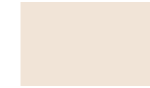

903 Magnolienweiß
903 Magnolia white

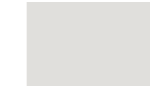

955 Space Grey
955 Space grey

SOCKELFARBEN

PLINTH COLORS



870 Seeahorn-Nb.
870 Sea maple effect



850 Havanna Eiche-Nb.
850 Havana oak effect



153 Schwarz glänzend
153 Gloss black



122 Cranberry
122 Cranberry

SCHUBKASTEN

DRAWER

505 Schubkastenvariante Vollauszug
505 Full-extension drawer variant

ARBEITSPLETTEN

WORKTOPS



677 Seeahorn-Nb.
677 Sea maple effect



131 Steinstruktur Grün
131 Stone structure, green



129 Terrazzo Lapisgrau
129 Terrazzo, lapis grey



669 Grafit
669 Graphite



127 Wildahorn-Nb. Alpin
127 Wild maple effect, alpine

WANGENFARBEN

PANEL COLOURS

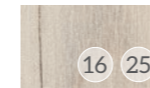

870 Seeahorn-Nb.
870 Sea maple effect



122 Cranberry
122 Cranberry



927 Kieselgrau
927 Pebble grey



127 Wildahorn-Nb. Alpin
127 Wild maple effect, alpine



925 Schwarz Hochglanz
925 High-gloss black



124 Cappuccino
124 Cappuccino



131 Steinstruktur Grün
131 Stone structure, green



902 Weiß
902 White



955 Space Grey
955 Space grey



129 Terrazzo Lapisgrau
129 Terrazzo, lapis grey

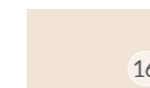

903 Magnolienweiß
903 Magnolia white



40 Alle Dekore in 40 mm Stärke
All decors in 40 mm thickness

Der Spezialist für Küchenmöbel aus Deutschland
mit attraktiven Preis-Leistungsverhältnis und
schneller Verfügbarkeit.

*The specialist for kitchen furniture
from Germany that offers attractive
value for money and fast availability.*

IMPULS
K Ü C H E N

Hinterm Gallberg · D-59929 Brilon
T + 49 2961 778 - 0
F + 49 2961 778 - 6110
E info@impuls-kuechen.de
W www.impuls-kuechen.de

Änderungen in Programmen,
Material, Ausführung, Abmes-
sung sowie bei Elektrogeräten
hinsichtlich technischer Ausfüh-
rung bleiben vorbehalten.

*We reserve the right to make chan-
ges to the ranges, material, finishes,
dimensions as well as to the techni-
cal design of electrical appliances.*



EIN KLICK - ALLE NEUHEITEN

Wir bieten Ihnen die Möglichkeit, die neuen Journale, alle Küchenabbildungen, Arbeitsplatten, Griffe und Korpusfarben in unserem Neuheiten-Portal herunter zu laden. Besuchen Sie hierzu die folgende Seite und wählen Sie zwischen den verschiedenen Downloads:



ONE CLICK - ALL NEW PRODUCTS

You can download the new journals, all the kitchen illustrations, worktops, handles and carcass colours in our New features portal. Simply go to the following page and choose between the various downloads available: